

MANUAL

IC-KP-R2-V1

**IDENTControl interface
with serial interface**

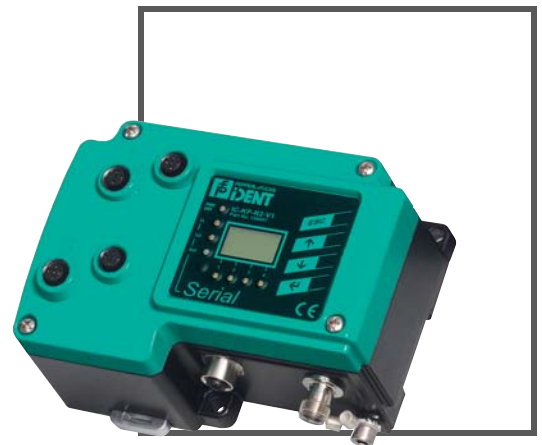

With regard to the supply of products, the current issue of the following document is applicable: The General Terms of Delivery for Products and Services of the Electrical Industry, published by the Central Association of the Electrical Industry (Zentralverband Elektrotechnik und Elektroindustrie (ZVEI) e.V.) in its most recent version as well as the supplementary clause: "Expanded reservation of proprietorship"

1	Introduction.....	5
2	Declaration of conformity	6
2.1	Declaration of conformity.....	6
3	Safety	7
3.1	Symbols relevant to safety.....	7
3.2	Intended use.....	7
3.3	General notes on safety	7
3.4	Contact protection	8
4	Product Description	9
4.1	Range of application.....	9
4.2	Device characteristics	9
4.3	Product family	9
4.3.1	R/W heads.....	9
4.3.2	Code / Data carrier.....	9
4.3.3	Handhelds	10
4.4	Displays and controls.....	10
4.5	Interfaces and connections	11
4.6	Delivery package.....	11
4.7	Connection accessories.....	12
4.7.1	Connection cable for R/W heads and trigger sensors.....	12
4.7.2	Cable connectors for the power supply	12
4.7.3	Connection cable to the serial interface	13
5	Installation.....	14
5.1	Storage and transport.....	14
5.2	Unpacking.....	14
5.3	EMC concept	14

5.4	Device connection	15
5.4.1	Power supply	15
5.4.2	Read/Write Head and Trigger Sensors	15
5.4.3	Cable length between control interface and R/W heads	16
5.4.4	Ground connection	16
5.4.5	Instructions for connecting the command interface	16
6	Commissioning	18
6.1	Commissioning	18
6.1.1	Connection	18
6.1.2	Device settings	18
6.1.3	Output of the contents of read data carriers on the display	19
6.1.4	Operating with the communication interface	20
7	Commands	22
7.1	General information on the serial interface	22
7.1.1	Command examples	22
7.2	Command types	24
7.3	Command overview	24
7.3.1	System commands	26
7.3.2	Standard read/write commands	31
7.3.3	Special command modes	33
7.4	Legend	42
7.5	Fault/status messages	43
8	Technical Specifications	44
8.1	Dimensions	44
8.2	General data	44
9	Troubleshooting	46
9.1	Fault location	46
10	ASCII table	47

1 Introduction

Congratulations

You have chosen a device manufactured by Pepperl+Fuchs. Pepperl+Fuchs develops, produces and distributes electronic sensors and interface modules for the market of automation technology on a worldwide scale.

Before installing this equipment and put into operation, read this manual carefully. This manual contains instructions and notes to help you through the installation and commissioning step by step. This makes sure bring such a trouble-free use of this product. This is for your benefit, since this:

- ensures the safe operation of the device
- helps you to exploit the full functionality of the device
- avoids errors and related malfunctions
- avoids costs by disruptions and any repairs
- increases the effectiveness and efficiency of your plant

Keep this manual at hand for subsequent operations on the device.

After opening the packaging please check the integrity of the device and the number of pieces of supplied.

Symbols used

The following symbols are used in this manual:



Note!

This symbol draws your attention to important information.



Handling instructions

You will find handling instructions beside this symbol

Contact

If you have any questions about the device, its functions, or accessories, please contact us at:

Pepperl+Fuchs GmbH
Lilienthalstraße 200
68307 Mannheim
Telephone: +49 621 776-4411
Fax: +49 621 776-274411
E-Mail: fa-info@pepperl-fuchs.com



2 Declaration of conformity

2.1 Declaration of conformity

This product was developed and manufactured under observance of the applicable European standards and guidelines.



Note!

A Declaration of Conformity can be requested from the manufacturer.

The product manufacturer, Pepperl+Fuchs GmbH, D-68307 Mannheim, has a certified quality assurance system that conforms to ISO 9001.



3 Safety

3.1 Symbols relevant to safety



Danger!

This symbol indicates an imminent danger.
Non-observance will result in personal injury or death.



Warning!

This symbol indicates a possible fault or danger.
Non-observance may cause personal injury or serious property damage.



Caution!

This symbol indicates a possible fault.
Non-observance could interrupt devices and any connected facilities or systems, or result in their complete failure.

3.2 Intended use

The IDENTControl IC-KP-R2-V1 is a control interface including a serial interface for identification systems. The device can be used as a control cabinet module or for field applications. Besides the serial connection, suitable inductive R/W heads, microwave antennas or trigger sensors can be connected. Wiring suitable for the system design must be used.

3.3 General notes on safety

Only instructed specialist staff may operate the device in accordance with the operating manual.

User modification and or repair are dangerous and will void the warranty and exclude the manufacturer from any liability. If serious faults occur, stop using the device. Secure the device against inadvertent operation. In the event of repairs, return the device to your local Pepperl+Fuchs representative or sales office.

The connection of the device and maintenance work when live may only be carried out by a qualified electrical specialist.

The operating company bears responsibility for observing locally applicable safety regulations.

Store the not used device in the original packaging. This offers the device optimal protection against impact and moisture.

Ensure that the ambient conditions comply with regulations.



Note!

Disposal

Electronic waste is hazardous waste. When disposing of the equipment, observe the current statutory requirements in the respective country of use, as well as local regulations.



3.4 Contact protection

Our housings are manufactured using components made partly or completely from metal to improve noise immunity.

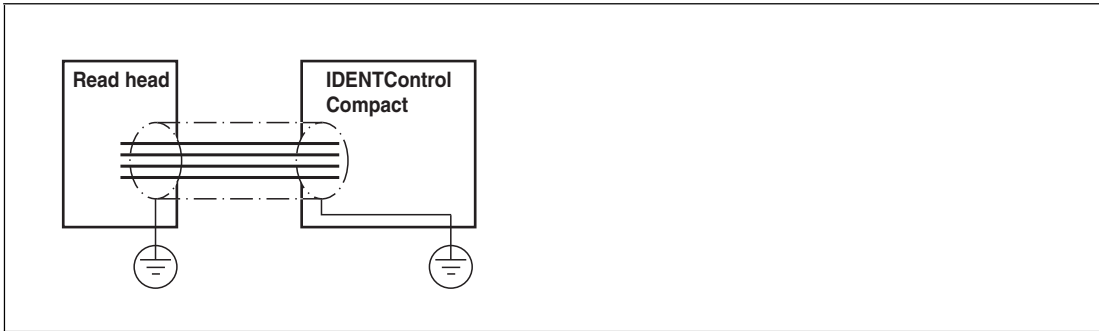

Danger!

Electric shock

The metallic housing components are connected to ground to protect against dangerous voltages that may occur in the event of a fault in the SELV power supply!

4 Product Description

4.1 Range of application

The system is suited for the following applications:

- Automation
- Material flow control in production
- Acquisition of operating data
- Access control
- Identification of storage vessels, pallets, work piece carriers, refuse containers, tanks, containers, etc.

4.2 Device characteristics

- Up to 4 R/W heads can be connected
- Alternatively up to 2 R/W heads and 2 trigger sensors can be connected
- LCD indicator with background illumination
- Direct operation using 4 function keys
- LED status indicator for bus communication and R/W heads

4.3 Product family

The IDENTControl brand name represents a complete identification system. The system consists of an IDENTControl interface including bus interface, inductive R/W heads (125 kHz and 13.56 MHz) and accompanying code and data carriers in many different designs. The IDENTControl can be connected to other identification systems.

The system is equally well suited for use in the switching cabinet and for field use in IP67. The interface to the controlling fieldbus is integrated into the enclosure and all connections are implemented as plugs. This enables simple installation and quick, correct replacement in case of device failure. The consistent EMC design (metal enclosure, grounding, shielded wires) offers a high degree of noise immunity. Function buttons are available for parameterization and entering commands directly into the IDENTControl.

4.3.1 R/W heads

There are different R/W heads available for the IDENTControl in different designs. You can connect inductive R/W heads (125 kHz and 13.56 MHz) depending on your particular application.

4.3.2 Code / Data carrier

Read only / read/write tag 125 kHz (inductive)

A wide range of read only and read/write tag designs are available for this frequency range, from a 3 mm thin glass tube to a transponder 50 mm in diameter. Read/write tags are available for temperatures up to 300 °C (max. 5 min) in chemical-resistant housings for installation in metal and in degree of protection IP68/IP69K. IPC02-... read only tags offer 40-bit read only codes. IPC03-... read/write tags have a 928-bit freely programmable memory bank and an unmodifiable 32-bit read only code. You can define 40-bit read only codes with IPC11-... read only tags. You can use these as permanent read only codes or continually redefine them.

Read/write tag 13.56 MHz (inductive)

Read/write tags in this frequency range save larger quantities of data and offer a considerably higher reading speed than read/write tags of the 125 kHz system. IQH-* and IQH1-* read/write heads from Pepperl+Fuchs are compatible with most existing read/write tags that comply with standard ISO 15693. With the IQH2-* read/write heads you can use read/write tags that comply with standard ISO 14443A.



The 13.56 MHz technology even allows smart labels (read/write tags in the form of adhesive labels with printed barcode). Currently available read/write tags have a memory capacity of 64 bits of read only code and a maximum 2 KB of programmable memory.

4.3.3 Handhelds

There are various handheld read/write devices available for controlling processes (write/read functions, initialization of data carriers).

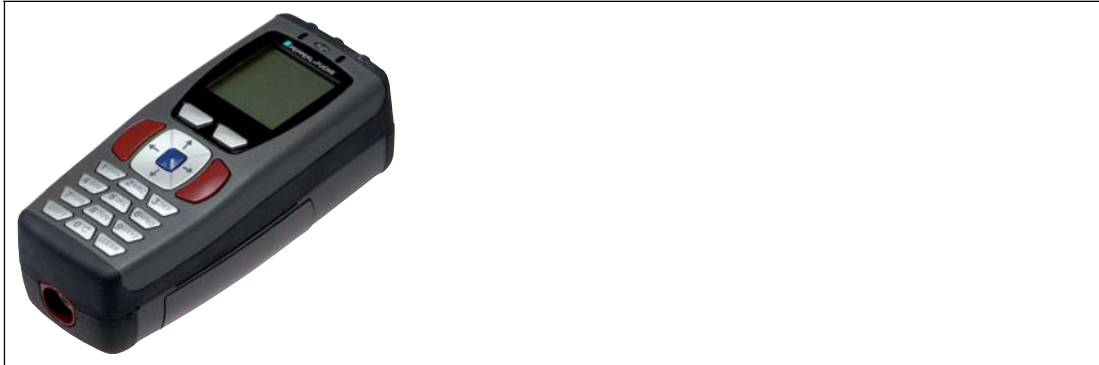
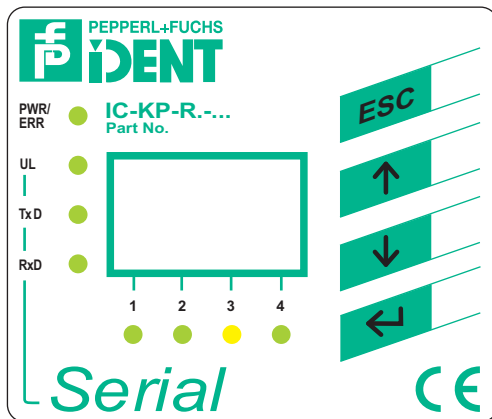

Figure 4.1

Handheld	Frequency range
IPT-HH20	125 kHz
IST-HH20	250 kHz
IQT1-HH20	13.56 MHz
IC-HH20-V1	depending on the read/write head

4.4 Displays and controls





The following displays and controls are located on the control interface.



LED indicators		
PWR/ERR	Power on Hardware error	green red
1, 2, 3, 4	Status display for R/W heads Command on R/W head is active Command executed successfully (approx. 1 second)	green yellow
UL	Interface ready for operation	green
TxD	IDENTControl sends data	green
RxD	IDENTControl receives data	green

2014-03

Display
Two-line multifunction display with 12 characters per line for displaying different status and operating information and four pictograms for displaying connected reading heads.

Push buttons
Push buttons are used for controlling the display and selecting commands when programming the control interface.
 Return to higher level
 Up menu item
 Down menu item
 RETURN (confirm input)

4.5 Interfaces and connections

The following interfaces and connections are located on the control interface IC-KP-R2-V1.

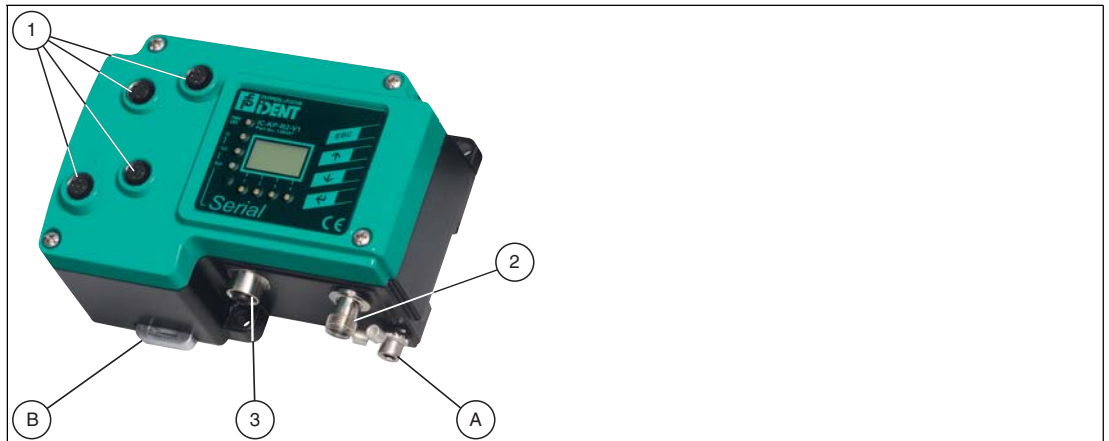

Connections

- 1** M12 connector for R/W heads (sockets) - V1
- 2** M12 connector for power supply (plug) - V1
- 3** M12 socket for serial interface - V1

Other accessories

- A** Screw for ground
- B** Metal latches for mounting the DIN rail

Accessories

Accessories see chapter 4.7.

4.6 Delivery package

The delivery package contains:

- 1 IDENTControl control interface
- 1 quick start guide
- 1 grounding screw (already fitted)
- 1 serrated lock washer (already fitted)
- 2 crimp connectors (already fitted)



4.7 Connection accessories

4.7.1 Connection cable for R/W heads and trigger sensors

Compatible connection cables with shielding are available for connecting the R/W heads and trigger sensors.



Figure 4.2

Accessories	Description
2 m long (straight female, angled male)	V1-G-2M-PUR-ABG-V1-W
5 m long (straight female, angled male)	V1-G-5M-PUR-ABG-V1-W
10 m long (straight female, angled male)	V1-G-10M-PUR-ABG-V1-W
20 m long (straight female, angled male)	V1-G-20M-PUR-ABG-V1-W
Field attachable female connector, straight, shielded	V1-G-ABG-PG9
Field attachable male connector, straight, shielded	V1S-G-ABG-PG9
Field attachable female connector, angled, shielded	V1-W-ABG-PG9
Field attachable male connector, angled, shielded	V1S-W-ABG-PG9
Dummy plug M12x1	VAZ-V1-B3

4.7.2 Cable connectors for the power supply

Compatible M12 sockets with an open cable end for connecting the IDENTControl to a power supply are available in different lengths.



Figure 4.3

Accessories	Designation
Length 2 m (straight socket)	V1-G-2M-PUR
Length 5 m (straight socket)	V1-G-5M-PUR
Length 10 m (straight socket)	V1-G-10M-PUR

4.7.3 Connection cable to the serial interface

The IDENT Control IC-KP-R2-V1 has an M12 connector and is connected to the host using a suitable cable.

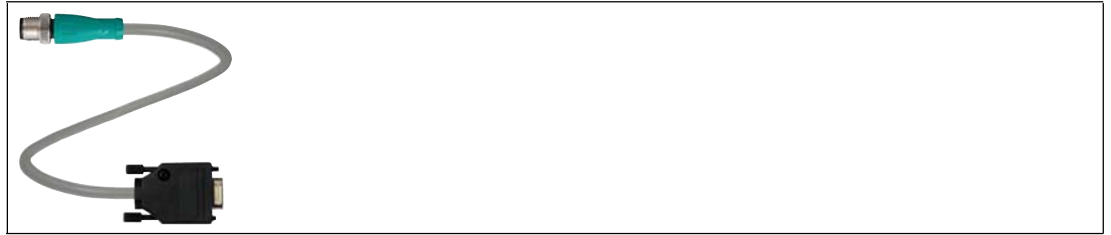

Figure 4.4

Accessories	Designation
M12 cable connector, shielded, field-attachable	V1S-G-ABG-PG9
Adapter cable, M12 to Sub-D (for connection to a PC using a null modem cable)	V1S-G-0.15M-PUR-ABG-SUBD
Null modem cable Sub-D	IVZ-K-R2

5 Installation

5.1 Storage and transport

For storage and transport purposes, package the unit using shockproof packaging material and protect it against moisture. The best method of protection is to package the unit using the original packaging. Furthermore, ensure that the ambient conditions are within allowable range.

5.2 Unpacking

Check the product for damage while unpacking. In the event of damage to the product, inform the post office or parcel service and notify the supplier.

Check the package contents with your purchase order and the shipping documents for:

- Delivery quantity
- Device type and version in accordance with the type plate
- Accessories
- Quick start guide

Retain the original packaging in case you have to store or ship the device again at a later date.

Should you have any questions, please contact Pepperl+Fuchs.

5.3 EMC concept

The outstanding noise immunity of the IDENTControl against emission and immission is based on its consistent shielding design, which uses the principle of the Faraday cage. Interference is caught in the shield and safely diverted via the ground connections.

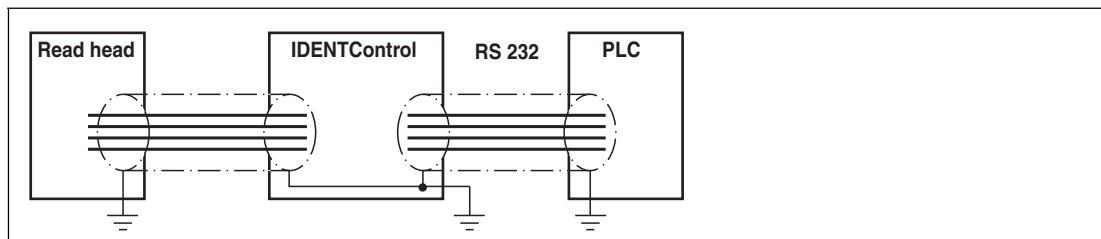

The cable shielding is used to discharge electromagnetic interference. When shielding a cable, you must connect both sides of the shield to ground with low resistance and low inductance.



Note!

If cables with double shields are used, e.g. wire mesh and metalized foil, the both shields must be connected together, with low resistance, at the ends when making up the cable.

Power supply cables are the source of much interference, e.g. from the supply lines of 3-phase electric motors. For this reason, the parallel laying of power supply cables with data and signal cables should be avoided, particularly in the same cable duct.

The metal enclosure of the IDENTControl and the metal enclosure of the R/W heads complete the consistent shielding concept.

The most important issue here is that the shields are connected to ground with low resistance and low inductance. The metal enclosure ensures that the shielding is not interrupted, i.e. the complete electronics system and all routed cables are located within a Faraday cage.

5.4 Device connection

Electrical connection using plug connectors makes installation simple.

5.4.1 Power supply

Connect the power supply via an M12 connector with integrated voltage and reverse polarity protection indicator (green: correct polarity, red: reverse polarity). A plug with the following pin assignment is located on the housing:



- 1 + 24 V
- 2 NC
- 3 GND
- 4 NC

Power supply AIDA

Connect the power supply for the IDENTControl using a connector that conforms with AIDA. A plug with the following pin assignment is located on the housing:



- 1 + 24 V
- 2 GND
- 3 n.c.
- 4 n.c.
- 5 n.c.

Compatible connecting cable see chapter 4.7.2.

5.4.2 Read/Write Head and Trigger Sensors

A maximum of 4 read/write heads can be connected to the IDENTControl.

Instead of the read/write heads, a maximum of 2 trigger sensors can be connected to sockets 3 and 4. A trigger sensor can be assigned to only one read/write head. The trigger sensors must be PNP.

Connect the read/write heads and trigger sensors to the sockets on the top of the enclosure using M12 connectors.

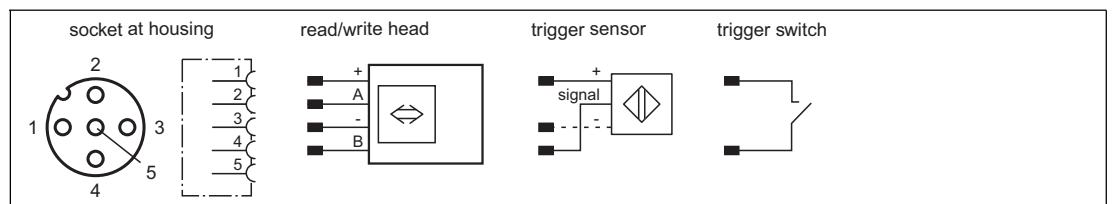

For details of compatible read/write heads and of compatible connecting cables, see chapter 4.7.1.



5.4.3 Cable length between control interface and R/W heads

The maximum cable length between the control interface and a connected R/W head is 1000 meters. If you wish to attain the maximum possible cable length, select a suitably large cable cross-section. See chapter 4.7.1

5.4.4 Ground connection

The ground connection of the IDENTControl is located at the lower right of the connector array. The ground conductor is screwed to the housing with a crimp connector. In order to guarantee safe grounding, the serrated washer must be mounted between the crimp connector and the housing.

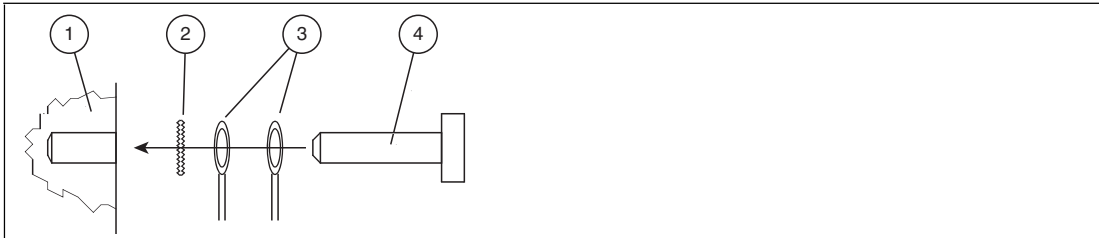

- 1 Housing
- 2 Serrated lock washer
- 3 Crimp connector
- 4 Lock screw

A cross-section of at least 4 mm² is recommended for the ground conductor lead.

5.4.5 Instructions for connecting the command interface

The IDENTControl is fitted with serial interface RS 232.

Select the transfer rate (baud rate) using the software or the display.

The following transfer rates are available:

- 1200, 2400, 4800, 9600, 19200, 38400 bits/s

The status is preset at 9600 Mbit/s on delivery.

The device operates with the following parameters (permanent):

- 8 data bits
- 1 start bit
- 1 stop bit
- No parity

Connect the RS 232 interface via a 4-pin M12 socket. You must place the cable shield on the thread in the connector plug.



Pin assignment of the M12 socket for RS 232

- 1 NC
- 2 RxD
- 3 GND
- 4 TxD

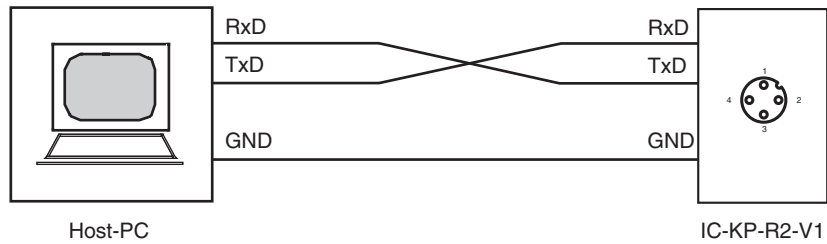

Transfer rates, line lengths and line types

The maximum length of the cable between the control unit and the higher level computer depends on the transfer rate and the noise level. We recommend the following guide value:

Standard	Max cable length
RS232	15 m



6 Commissioning

6.1 Commissioning

6.1.1 Connection



Warning!

Before commissioning, check once again that the connections are correct.

After the supply voltage is connected, the green LED in the voltage connector and the PWR and UL LEDs on the display panel must light up. If the LED in the connector lights up red, the polarity of the power supply is reversed.

6.1.2 Device settings



Warning!

Device not configured or configured incorrectly

Configure the device prior to commissioning. A device that has not been configured or configured incorrectly may lead to faults in the plant.

You must set the various parameters prior to commissioning.

The parameters are volatile and non-volatile parameters. Volatile parameters are reset to their default setting when the system is switched off and on again.

Non-volatile parameters

Parameter	Default setting	Value range
General		
LCD contrast	50	36 ... 71
LCD light	On	On / off
Language	English	English / German
Multiplex mode	off	On / off
R/W head		
Trigger mode	off	On / off
Tag type	99	00 ... FF

RS 232 interface		
Baud rate	9600	1200, 2400, 4800, 9600, 19200, 38400
Timeout	0	0 ... 100

Volatile parameters

Parameter	Default setting	Value range
R/W head		
Password mode	Off	on / off
Password	00000000	00000000 ... FFFFFFFF

Configure the read/write station with the described system commands. "99" is preset as the tag type.

Operating the device

The following illustration shows how the device is operated directly:

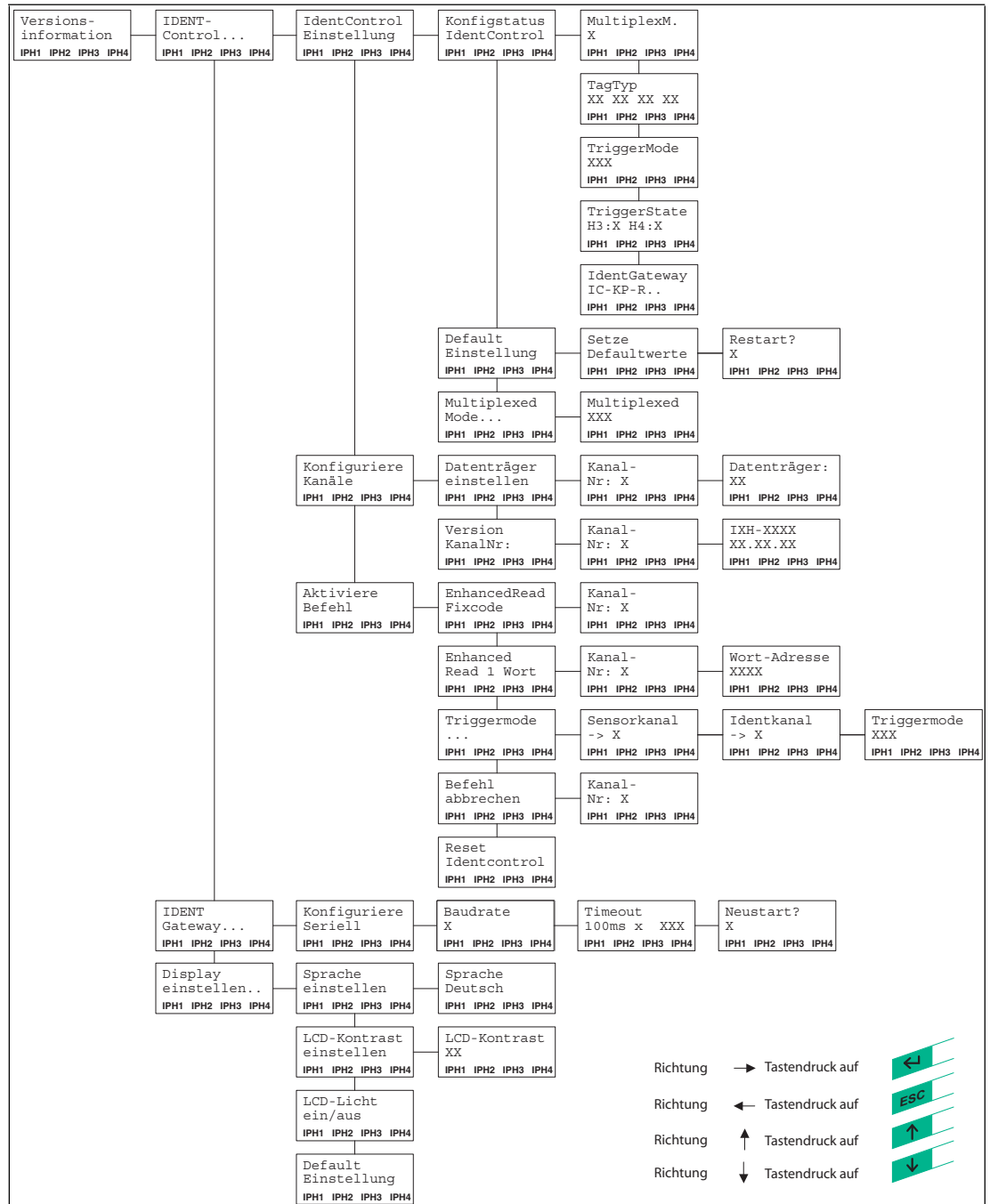

6.1.3 Output of the contents of read data carriers on the display

In the first menu level, the IDENTControl shows the contents of read data carriers on the display. Information messages of this kind are marked with a bell icon (🔔) in the top right corner of the display to distinguish them from menu items.

A maximum of the first 12 characters of the read data set can be displayed. The following characters may be excluded.

The view on the display can be toggled by pressing the arrow buttons. The following display variants are available:



- HEX (hexadecimal with decimal delimiter)
- HEX2 (hexadecimal without decimal delimiter)
- ASCII (ASC)



Note!

Data carrier content from commands that are activated manually on the IDENTControl are always displayed, irrespective of the menu level that was just displayed.

6.1.4 Operating with the communication interface

The procedure for commissioning the IDENTControl IC-KP-R2-V1 using the serial RS 232 interface in conjunction with a PC and an IPC03 data carrier is described in the following section. It is assumed that the IDENTControl is in factory default condition when all of the following steps are performed.

The factory set transfer rate is 9600 baud and no timeout. '99' is the preset tag type (depending on the reading head).

Check that you have connected an RS 232 interface.

The transfer rate (baud rate) is selected using the software (see chapter 5.4.5).

The following transfer rates are available:

- 1200, 2400, 4800, 9600, 19200, 38400 bits/s

The status is preset at 9600 Mbit/s on delivery.

The device operates with the following parameters (permanent):

- 8 data bits
- 1 start bit
- 1 stop bit
- No parity



Initial operating steps

1. Start a terminal program on the PC (e.g. Hyperterminal or the command input window program from the "RFIDControl" software. The "RFIDControl" software can be downloaded from our website <http://www.pepperl-fuchs.com>).
2. Set the following interface configuration on the terminal program:
 - 9600 baud
 - 8 data bits
 - no parity
 - 1 stop bit
 - no protocol/handshake
3. Switch the device operating voltage off and on.
 - ↳ The following message appears on the terminal when the voltage is switched on:
2 0 b <ETX>
 "2" = Status
 "0" = R/W head number
 "b" = Check sum
 "<ETX>" = End character
 Communication between the device and the terminal program is active. The device is ready for operation.
4. Send the version command **VE#<CR>** from the terminal as confirmation.
 - ↳ The name, article number and a version message for the connected device is displayed in response.

Example:

```
00 P+F IDENT<CR><LF>
IC-KP-R2-V1<CR><LF>
#126457<CR><LF>
1830373 <CR><LF>
01.07.05 #<CR> ...
```

Details of connected R/W heads follow. For the complete response, see see chapter 7.3.1.



Note!

If you receive different responses, communication between your PC and the device has failed (the software number and the software date may vary). Check the installation and repeat the steps for commissioning the device.



Note!

The device makes no distinction between commands entered in upper and lower case. However, make sure that there are no spaces in all parameters that come after the command.

Protocol with check sum

All commands conclude with the characters <CHCK> = "check sum" and <ETX> = "end of text" (<ETX> = 03h). This serves to secure the data of the serial transfer.

For simplified usage with a standard terminal, the control unit also accepts a #<CR> [<LF>] in place of <CHCK><ETX>.



Note!

Use of the check sum increases data security to the interface.

Check sums are formed simply by adding all preceding characters, without overrun.

The following is an example of check sum calculation:

The check sum should be defined for telegrams **VE#<CR>** or **ve#<CR>** without a check sum.

First the hexadecimal values for the characters "V"=56h and "E"=45h or "v"=76h and "e"=65h are required from an ASCII table. Adding these values produces the following results.

- "V" = 56h plus "E" = 45h produces the sum 9Bh or
- "v" = 76h plus "e" = 65h produces the sum DBh.

The check sum for the telegram is therefore

- VE<9Bh><ETX> or
- ve<DBh><ETX>.

If a longer telegram is transferred, the check sum will most likely overrun, which essentially means that calculated values can no longer be represented by a single byte when added together. The overrun is not transmitted.

Transferring the telegram **ER1000702#<CR>** with check sum produces the following check sum:

- 45h + 52h + 31h + 30h + 30h + 30h + 37h + 30h + 32h = 1F1h.

When the overrun is removed, the following check sum remains:

- ER1000702<F1h><ETX>.



Note!

The device makes no distinction between commands entered in upper and lower case. However, remember that upper and lower case characters produce different check sums.



7 Commands

7.1 General information on the serial interface

The serial RS-232 interface enables the quick and easy connection of an IDENTControl to a PC or PLC. The configuration of device addresses is not required. The configuration is limited setting the required baud rate. Commands can be sent to the IDENTControl using any terminal program.

7.1.1 Command examples



1. Example: Setting the tag type

Tag type IPC02 is preset on delivery.

Send the command **Change tag** described in the **Command** table to select the tag type IPC03 for the R/W head connected to channel 1.

↳ You should receive one of the responses described in the **Response** table.

Command:

CT 1 03 # <CR>	
CT	Command Change tag
1	Channel 1
03	Tag type IPC03
#	End character
<CR>	End character

Response:

0 1 # <CR>	
0	Status
1	Channel 1
#	End character
<CR>	End character

The response indicates that the R/W head on channel 1 has received the command (status = '0').



Note!

The tag type is stored in the non-volatile memory for each channel of the control interface.

If you would like to apply the **Change tag** command to all channels, use <Ident channel> "x".

Command:

CT x 03 # <CR>	
CT	Command Change tag
x	All channels
03	Tag type IPC03
#	End character
<CR>	End character

You will receive the following response for all four channels:

```
<Status><Ident channel>#<CR>
<Status><Ident channel>#<CR>
<Status><Ident channel>#<CR>
<Status><Ident channel>#<CR>
```



2. Example: Writing two double words from address 7 with R/W head on channel 1

To write two double words to channel 1 from address 7 with a R/W head, proceed as follows.

1. Position an IPC03 data carrier in front of the R/W head on channel 1.
2. Send the command **Single write words**.

SW 1 0007 02 ABCDEFGH # <CR>	
SW	Command Single write words
1	Channel 1
0007	Address (in hexadecimal format)
02	Number of double words (4-byte words)
ABCDEFGH	Data
#	End character
<CR>	End character

If the data carrier is within the detection range, you will receive the message **01#<CR>**.

In any other scenario, **51#<CR>** is issued to indicate that writing was not possible because the data carrier was outside the detection range (status = '5').

LED 1 on the IDENTControl and the LEDs on the R/W head briefly light up green when the reading command is activated and then yellow if the command is executed successfully.



3. Example: Reading two double words from address 7 with R/W head on channel 1

To read two double words to channel 1 from address 7 with a R/W head, proceed as follows. Send the read command **Enhanced buffered read words**.

ER 1 0007 02 # <CR>	
ER	Command Enhanced buffered read words
1	Channel 1
0007	Address (in hexadecimal format)
02	Number of double words
#	End character
<CR>	End character

If you then move a data carrier into the detection range, the data previously imported is displayed with the message:

0 1 ABCDEFGH # <CR>	
0	Status
1	Channel 1
ABCDEFGH	Data
#	End character
<CR>	End character

7.2 Command types

When using commands, a distinction is always made between the two command types **single mode** and **enhanced mode**.

Single mode

The command is executed once. A response is issued immediately.

Enhanced mode

The command remains permanently active until it is interrupted by the user or by an error message. A response is issued immediately.

The command remains active after the response is issued. Data is only transferred if read/write tags change. Read/write tags are not read twice. If a read/write tag leaves the read range, the status '5' is output.

7.3 Command overview

The commands in the list are described in detail on the following pages.

System commands

Command description	Abbreviation
See "Version (VE):" on page 26	VE
See "Change tag (CT):" on page 26	CT
See "Quit (QU):" on page 28	QU
See "Configure interface (CI):" on page 29	CI
See "Configuration store (CS):" on page 29	CS
See "Get state (GS):" on page 29	GS
See "Reset (RS):" on page 29	RS
See "Reset to defaults (RD):" on page 30	RD
See "Set multiplexed mode (MM):" on page 30	MM
See "Set trigger mode (TM):" on page 30	TM

Standard read/write commands

Fixcode

Command description	Abbreviation
See "Single read read only code (SF):" on page 31	SF
See "Enhanced buffered read read only code (EF):" on page 31	EF

Read data

Command description	Abbreviation
See "Single read words (SR):" on page 31	SR
See "Enhanced buffered read words (ER):" on page 31	ER

Write data

Command description	Abbreviation
See "Single write words (SW):" on page 31	SW
See "Enhanced buffered write words (EW):" on page 32	EW

Special command modes

Password mode with IPC03

Command description	Abbreviation
See "Set password mode (PM):" on page 34	PM
See "Change password (PC):" on page 34	PC
See "Set password (PS):" on page 35	PS

Configuration IPC03

Command description	Abbreviation
See "Single get configuration (SG):" on page 35	SG
See "Enhanced buffered get configuration (EG):" on page 35	EG
See "Single write configuration (SC):" on page 36	SC
See "Enhanced buffered write configuration (EC):" on page 36	EC

Extended commands for tag type IPC11 and IDC-..-1K

Command description	Abbreviation
See "Single write read only code (SX):" on page 37	SX
See "Enhanced buffered write read only code (EX):" on page 37	EX
See "Set tag ID code (TI):" on page 38	TI
See "Fill data carrier (S#):" on page 38	S#

Extended commands for tag type IDC-...-1K

Command description	Abbreviation
See "Single read special read only code (SS):" on page 39	SS
See "Enhanced read special read only code (ES):" on page 39	ES
See "Single program special read only code (SP):" on page 39	SP
See "Enhanced program special read only code (EP):" on page 39	EP
See "Initialize data carrier (SI):" on page 40	SI

Extended commands for type IQC-... read/write tags.

Command description	Abbreviation
See "Single write words with lock (SL)" on page 40	SL
See "Enhanced write words with lock (EL)" on page 40	EL

Extended commands for IQH2-... read/write heads

Command description	Abbreviation
See "Read Parameters" on page 40	RP
See "Write Parameters" on page 41	WP



Note!

In the following descriptions, the commands are highlighted in bold. Text that appears in < ... > is explanatory text for the command sequence.



Note!

The device makes no distinction between commands entered in upper and lower case. Make sure that there are **no spaces** in all parameters that come after the command.

7.3.1 System commands

Version (VE):

Command:	VE <CHCK><ETX>
Response:	<Status> P+F IDENT <Model type> #<Part no.> <SW no.> <SW date> <CHCK> <ETX>
(Channel 1)	<Status> <Ident channel> <LkName> #<Part no.> <SW no.> <SW date> <CHCK> <ETX>
(Channel 2)	<Status> <Ident channel> <LkName> #<Part no.> <SW no.> <SW date> <CHCK> <ETX>
(Channel 3)	<Status> <Ident channel> <LkName> #<Part no.> <SW no.> <SW date> <CHCK> <ETX>
(Channel 4)	<Status> <Ident channel> <LkName> #<Part no.> <SW no.> <SW date> <CHCK> <ETX>

This command transfers the device names and the date of the software versions.

If there is no R/W head connected, the R/W head information is omitted and 6<Ident channel><CHCK><ETX> is displayed to indicate that the R/W head was unavailable (status = '6').

Change tag (CT):

Command:	CT <Ident channel><TagType><CHCK><ETX>
Response:	<Status><Ident channel><CHCK><ETX>

This command tells the read/write head on the relevant channel which tag type to communicate with. This setting is stored in the non-volatile memory on the unit.

Supported Tag Types

Tag type		P+F designation	Chip type	Access	Writable memory [bytes]	Read only code length [byte]	Frequency range
High byte	Low byte						
'0'	'2'	IPC02	Unique, EM4102 (EM microelectronic)	Read only code	5	5	125 kHz
'0'	'3'	IPC03	EM4450 (EM microelectronic), Titan	Read/write read only code	116	4	125 kHz
'1'	'1'	IPC11	Q5 (Sokymat)	Read/write	5	-	125 kHz
'1'	'2'	IPC12	P+F FRAM	Read/write read only code	8k	4	125 kHz

2014-03

Tag type		P+F designation	Chip type	Access	Writable memory [bytes]	Read only code length [byte]	Frequency range
High byte	Low byte						
'2'	'0'	IQC20 ¹⁾	All ISO 15693 compliant read/write tags	Read/write read only code	8	8	13.56 MHz
'2'	'1'	IQC21	I-Code SLI (NXP)	Read/write read only code	112	8	13.56 MHz
'2'	'2'	IQC22	Tag-it HF-I Plus (Texas Instruments)	Read/write read only code	250	8	13.56 MHz
'2'	'3'	IQC23	my-D SRF55V02P (Infinition)	Read/write read only code	224	8	13.56 MHz
'2'	'4'	IQC24	my-D SRF55V10P (Infinition)	Read/write read only code	928	8	13.56 MHz
'3'	'1'	IQC31	Tag-it HF-I Standard (Texas Instruments)	Read/write read only code	32	8	13.56 MHz
'3'	'3'	IQC33 ²⁾	FRAM MB89R118 (Fujitsu)	Read/write read only code	2k	8	13.56 MHz
'3'	'4'	IQC34	FRAM MB89R119 (Fujitsu)	Read/write read only code	29	8	13.56 MHz
'3'	'5'	IQC35	I-Code SLI-S (NXP)	Read/write read only code	160	8	13.56 MHz
'4'	'0'	IQC40	All ISO 14443A compliant read/write tags	Read only code	-	4/7 ⁶⁾	13.56 MHz
'4'	'1'	IQC41	Mifare UltraLight MF0 IC U1 (NXP)	Read/write read only code	48	7	13.56 MHz
'4'	'2'	IQC42 ³⁾	Mifare Classic MF1 IC S50 (NXP)	Read/write read only code	752	4/7 ⁶⁾	13.56 MHz
'4'	'3'	IQC43 ³⁾	Mifare Classic MF1 IC S70 (NXP)	Read/write read only code	3440	4/7 ⁶⁾	13.56 MHz
'5'	'0'	IDC-...-1K	P+F	Read/write read only code	125	4	250 kHz
'5'	'2'	ICC-...	P+F	Read only code	28	7	250 kHz
'7'	'2'	IUC72 ₄₎	UCode-EPC-G2XM (NXP)	Read/write read only code	64	8	868 MHz
'7'	'3'	IUC73 ₄₎	Higgs-2 (Alien)	Read only code	-	96	868 MHz
'7'	'4'	IUC74 ₄₎	UCode-EPC-G2 (NXP)	Read/write read only code	28	96	868 MHz
'7'	'5'	IUC75 ₄₎	Monza 2.0 (Impinj)	Read only code	-	96	868 MHz
'7'	'6'	IUC76 ₄₎	Higgs-3 (Alien)	Read/write read only code	56	240	868 MHz
'8'	'0'	-	All Class 1 Gen 2 compliant read/write tags	-	-	Max. 96	868 MHz
'9'	'9'	Depends on the reader ⁵⁾	-	-	-	-	-



- 1) IQC20 is not an actual tag type as such, but is used to read the UID (read only code) of all ISO 15693 compliant read/write tags.
- 2) Read/write tag IQC33 can only be used in combination with a IQH1-... read/write head. The memory is divided into 8-byte blocks (instead of 4-byte blocks). You must enter a continuous initial address for write commands SR, ER, SW and EW.
<WordNum> specifies the number of 8-byte blocks (here, max. 7) and must be an even number.
- 3) Read/write tags IQC40–IQC43 can only be used in combination with a IQH2-... read/write head.
<WordNum> specifies the number of 16-byte blocks and must be a multiple of 4.
The memory can be encrypted for each sector (1 sector = 4 blocks of 16 bytes).
The default key in the tag and reader is FF FF FF FF FF FF ASCII. The key in the reader can be read using the `Read param` command and written using the `Write param` command (see System Commands). The key is only changed in the reader during this process and not in the tag!
The key in the reader is stored in the non-volatile memory.
- 4) IUC7* type read/write tags can only be used with read/write head IUH-F117-V1 in combination with certain control interfaces.
- 5) The tag type configured in the read/write head as the default is selected.
- 6) Read/write tags can have 4-byte (older versions) or 7-byte UIDs. IQC42 and IQC43 type read/write tags from Pepperl+Fuchs generally have 7-byte UIDs.



Note!

In a plant where only one tag type is used, it is advantageous to permanently configure that tag type so that the read/write head detects the tag quicker.

Default tag type:

In the factory default condition, the tag type 99 is preset in the IDENTControl (depending on the reading head type), thus the tag type preset on the reading head is used.



Note!

With <Ident channel> “x”, a command is applied to all channels.

Quit (QU):

Command:	QU <Ident channel><CHCK><ETX>
Response:	<Status><Ident channel><CHCK><ETX>

The command running on this channel is interrupted.

Configure interface (CI):

Command:	CI <Timeout>,<Baud><CHCK><ETX>
Response:	<Status><Ident channel><CHCK><ETX>

This command sets the timeout and the baud rate. The values are stored in the non-volatile memory of the control unit.



Note!

The device settings stored in the non-volatile memory always become active after a reset.

The timeout command indicates the amount of time after which the device no longer waits for more characters in a command. After the timeout expires, the user receives an error message. To deactivate the timeout, you must set the time to "0".

The number of data bits is always 8. A parity bit is never used. The following settings are possible:

<Timeout>: "0"... "100" (x 100 ms, timeout in 100 ms steps)
 <Baud>: "1200" , "2400" , "4800" , "9600" , "19200" , "38400"

The default values are a timeout of "0" and a baud rate of "38400".

Configuration store (CS):

Command:	CS <Ident channel><Mode><CHCK><ETX>
Response:	<Status><Ident channel><CHCK><ETX>

The configuration store (CS) command allows you to store the last command sent to the R/W head in the non-volatile memory of the IDENTControl Compact. The R/W head executes the command automatically again if the power supply is interrupted or the IDENTControl Compact is reset.

<Mode>='1' activates the mode.
 <Mode>='0' deactivates the mode.

Configuration store is deactivated by default.

Get state (GS):

Command:	GS <CHCK><ETX>
Response:	<Status><Ident channel> TO:<Timeout> BD:<Baud> HD1:<Status><TagType> HD2:<Status><TagType> HD3:<Status><TagType> HD4:<Status><TagType> MM:<OnOff> TM3:<Ident channel><Trigger mode> TM4:<Ident channel><Trigger mode><CHCK><ETX>

This command is used to read the device settings stored in the non-volatile memory of the control interface, which become active after the next reset.

Reset (RS):

Command:	RS <CHCK><ETX>
Response:	2<Ident channel><CHCK><ETX>

This command terminates all active commands. The device settings are reloaded from the non-volatile memory.

<Ident channel>=0 allows you to assign the trigger signal to channel '0' so that the trigger signal is transmitted to the controller and not to a read head.

This function can be used to monitor functions via the PLC if trigger signals and reading of data cannot occur simultaneously for application related reasons. Correlation must take place in the PLC.

7.3.2 Standard read/write commands

Single read read only code (SF):

Command:	SF <Ident channel><CHCK><ETX>
Response:	<Status><Ident channel><Data><CHCK><ETX>

The R/W head makes only one attempt to read a read only code.

The length of the read only code that is output depends on the tag type. See table "Supported Tag Types" on page 26.

Enhanced buffered read read only code (EF):

Command:	EF <Ident channel><CHCK><ETX>
Response:	<Status><Ident channel><Data><CHCK><ETX>

The R/W head makes attempts until successful to read a read only code. Only data that changes is transferred via the interface, i.e. the R/W head transfers data whenever it reads a new read/write tag or whenever it reads a read/write tag where there was previously no read/write head within the detection range.

The status '05h' (read command) is output whenever a read/write tag leaves the detection range.

The length of the read only code that is output depends on the tag type. See table "Supported Tag Types" on page 26.

Single read words (SR):

Command:	SR <Ident channel><WordAddr><WordNum><CHCK><ETX>
Response:	<Status><Ident channel><Data><CHCK><ETX>

The R/W head makes one attempt to read <WordNum> 32-bit words from the address<WordAddr>.

Enhanced buffered read words (ER):

Command:	ER <Ident channel><WordAddr><WordNum><CHCK><ETX>
Response:	<Status><Ident channel><Data><CHCK><ETX>

The R/W head makes attempts until successful, to read <WordNum> 32-bit words from the address <WordAddr>. Only modified data is transferred via the interface.

When a read/write tag leaves the detection range, the status '05h' (read command) is output.

Single write words (SW):

Command:	SW <Ident channel><WordAddr><WordNum><Data> <CHCK><ETX>
Response:	<Status><Ident channel><CHCK><ETX>

The R/W head makes one attempt to write <WordNum> 32-bit words from the address<WordAddr>.



Enhanced buffered write words (EW):

Command:	EW <Ident channel><WordAddr><WordNum><Data> <CHCK><ETX>
Response:	<Status><Ident channel><CHCK><ETX>

The read/write head repeatedly attempts to write <WordNum> 32-bit words from the address <WordAddr> until successful. After each successful write, the head sends the response and then switches to continuous read. The read/write head then reads the same tag until the tag has left the detection range or a new tag appears within the detection range. At this point, the read/write head again starts write attempts.

The status '05h' is only output when a tag leaves the detection range or is not yet within the detection range.

If two tags enter the read range one immediately after the other, the status '05h' is not issued between the two readings.

7.3.3 Special command modes



Note!

You can only use the commands in this section for the data carrier type '03' (IPC03).

IPC03 Configuration

The storage of a data carrier IPC03 is organized by word. A data word is defined with a length of 32 bits. For the normal data range, 29 words from addresses 3 through 31 (<WordAddr> = 00h ... 1Ch) are available.

Address	Meaning	<WordAddr>	<ConfAddr>	Note
Word 0	Password	-	-	Write only
Word 1	Protection word	-	1	Read/write
Word 2	Control word	-	2	Read/write
Word 3 ...31	Data range	00h ... 1Ch	-	Read/write
Word 32	Device Serial Number	1Dh	-	Read only
Word 33	Device identification	1Eh	-	Read only

Word 0 contains the password. The password can only be written.

With word 1, the "Protection Word", you can define a read-protected and a write-protected range. The "Protection Word" can only be read and written with the correct password.

With word 2, the "Control Word", you can set various operating modes and the read range for the operating mode "Default Read". The "Control Word" can only be read and written with the correct password.

If you would like to use the "Protection Word" and the "Control Word", you must first activate the password mode.

The individual bits have the following meanings:

Protection word		
Bit	Meaning	Byte
0 ... 7	First read-protected word	0
8 ... 15	Last read-protected word	1
16 ... 23	First write-protected word	2
24 ... 31	Last write-protected word	3

Control word		
Bit	Meaning	Byte
0 ... 7	Read range start	0
8 ... 15	Read range end	1
16	Password mode on/off	2
17	"Read after write" operating mode on/off	
18 ... 23	Open	3
24 ... 31	Open	

IPC03 password mode

If the password mode in the data carrier is activated, the data range of the data carrier is read and write-protected and can only be read or written if the R/W head sends the correct password to the data carrier.

If the password mode in the data carrier is deactivated, every data word on the data carrier can be read or written.

The default password of the R/W heads and the data carrier is 00000000h. In the R/W head, the password is stored in the volatile memory and in the data carrier, the password is stored in the non-volatile memory.

To read or write the "Protection Word" and the "Control Word", you must first enter the password in the password mode (see the commands **SC** or **EC**).

You can also limit access to the data carriers by defining the start and end of a read-protected and a write-protected range in the Protection Word.

Setting the password

1. Enter the correct password once with the command **PS** (set password).
2. Activate the password mode with the command **PM** (set password mode).

The password in the R/W head and on the read/write tag can be changed with the command **PC**.

If the password mode is deactivated, every data word on the read/write tag can be read and written as necessary.

To read and write the words 1 "Protection Word" and 2 "Control Word", the correct password is always required and therefore the password mode must be active (see the commands **SC** or **EC**).

In addition, the access to the read/write tag can be limited via read- and write-protected ranges. To achieve this, each mutually independent start and end of a read-protected and a write-protected range can be defined in the "Protection Word".

In the factory default condition of the reading heads and the read/write tag IPC03, the password is 00000000h. In the reading head, the password is stored in a volatile manner and in the read/write tag IPC03 in a non-volatile manner.

Set password mode (PM):

Command:	PM <Ident channel><P><CHCK><ETX>
Response:	<Status><Ident channel><CHCK><ETX>

The command **PM** activates and deactivates the password mode of the relevant channel. In the password mode, the password is transferred to the data carrier before each read/write access. If a data carrier is addressed with the wrong password, then even the other data areas on the data carrier can no longer be accessed.

Password mode "off": <P>=0 (0b) (deactivated)

Password mode "on": <P>=1 (1b) (activated)

Change password (PC):

Command:	PC <Ident channel><OldPW><NewPW><CHCK><ETX>
Response:	<Status><Ident channel><CHCK><ETX>

The command **PC** changes the password in a tag. Enter the old and then the new password <PSW> here. If the password has been successfully written, the password in the read/write head also changes and the **set password** command is no longer required. The password of the IPC03 can also be changed if the password mode is deactivated.



Set password (PS):

Command:	PS <Ident channel><PW><CHCK><ETX>
Response:	<Status><Ident channel><CHCK><ETX>

The command **PS** sets the password, which the R/W head communicates to the data carrier in password mode.

Operating mode "Default Read"

In "default read" operating mode, 1 or 2 words are read extremely quickly. The area of memory earmarked for reading is already specified on the tag. The R/W head does not have to identify the memory area for the tag.

The start and end of the read range are stored in the bytes 0 and 1 of the control word. As soon as power is supplied to the tag, it sends data from the data range defined by the start and end of the read range. The data range between read range start and end is read with the read commands **SR** (Single read words) and **ER** (enhanced buffered read words) when <WordAddr> is set to 0000h and <WordNum> to 00h.

The advantage of "default read" operating mode is the readout speed. The readout of one data word (4 bytes) is twice as fast in this mode as the other modes. The readout of two words takes approx. 1/3 less time. No more time advantages can be gained after three data words because "default read" mode is designed to read a maximum of two words (= 8 bytes). Reading larger data ranges can lead to error messages if the reading head does not respond within the planned reaction time.



Setting "Default Read"

1. Activate the password mode.
2. Write the read range start and end into the "Control Word".
3. Deactivate the password mode.
4. Read the data range with address designation 0000h and word count 0h.

IPC03 configuration

Single get configuration (SG):

Command:	SG <Ident channel><ConfAddr><CHCK><ETX>
Response:	<Status><Ident channel><Data><CHCK><ETX>

The R/W head makes exactly one attempt to read a word in the configuration range ("Protection Word" or "Control Word") from the address <ConfAddr>.

Enhanced buffered get configuration (EG):

Command:	EG <Ident channel><ConfAddr><CHCK><ETX>
Response:	<Status><Ident channel><Data><CHCK><ETX>

The R/W head attempts to read a word in the configuration range from the address <ConfAddr> until successful. Only data that changes is transferred via the interface, i.e. the R/W head transfers data whenever it reads a new data carrier or whenever it reads a data carrier where there was previously no R/W head within the detection range.

The status '05h' (read/write command) is output when the data carrier leaves the detection range or if the data carrier is not yet within the detection range when the command is executed.

If two data carriers enter the read range one immediately after the other, the status '05h' is not issued between the two readings.

Single write configuration (SC):

Command:	SC <Ident channel><ConfAddr><Data><CHCK><ETX>
Response:	<Status><Ident channel><CHCK><ETX>

The R/W head makes exactly one attempt to write a word to the configuration range ("Protection Word" or "Control Word") from the address <ConfAddr>.

The password mode must be active so that the R/W head can write to the configuration range. If the password mode is deactivated, every data word outside of the write-protected range can be written to. If you would like to modify the write-protected range, you must modify the "Protection Word" accordingly.

For example:

With the R/W head on channel 1, one data word (4 bytes) that does not contain details of the address and data length should be transferred during each read command (accessed with 00 byte and address 0000). Password mode must be activated beforehand by transmitting the command **Single configuration**.

SC 1 2 <00 _h ><00 _h ><03 _h ><03 _h > # <CR>	
SC	Single write configuration command
1	Channel (=1)
2	Word address in the configuration range (=control word)
00 _h 00 _h	Bits 16 ... 31 of the control word
03 _h	Address of the last data word to write
03 _h	Address of the first data word to write
#	End character
<CR>	End character

The address of the first and last data word to be written is based on the absolute address of the data carrier (not the <WordAddr>). The address 03_h is therefore the first available word in the data range.



Note!

Please note that the value '0033' must be sent in hexadecimal format. Refer to your terminal program for details.

Enhanced buffered write configuration (EC):

Command:	EC <Ident channel><ConfAddr><Data><CHCK><ETX>
Response:	<Status><Ident channel><CHCK><ETX>

The R/W head attempts to write a word in the configuration range to the address <ConfAddr> until successful. After each write, the status is evaluated and the system waits until a new data carrier is within the detection range. The command then starts again from the beginning. In order to write in the configuration range, the password mode must be active.

The status '05h' (read/write command) is only output when a data carrier leaves the detection range or is not yet within the detection range when the command is executed.

If two data carriers enter the read range one immediately after the other, the status '05h' is not issued between the two readings.

Single read special read only code (SS):

Command:	SS <Ident channel><FixLen><CHCK><ETX>
Response:	<Status><Ident channel><ID code><CHCK><ETX>

The R/W head makes only one attempt to read a **special read only code**.



Note!

The <FixLen> of IDC-...-1K read/write tags is always 6 bytes.

Enhanced read special read only code (ES):

Command:	ES <Ident channel><FixLen><CHCK><ETX>
Response:	<Status><Ident channel><Data><CHCK><ETX>

The R/W head attempts to read a **special read only code** until successful. Only data that changes is transferred via the interface, i.e. the R/W head transfers data whenever it reads a new data carrier or whenever it reads a data carrier where there was previously no R/W head within the detection range.

The status '05h' (read command) is output whenever a data carrier leaves the detection range.



Note!

The <FixLen> of IDC-...-1K read/write tags is always 6 bytes.

Single program special read only code (SP):

Command:	SP <Ident channel><FixLen><Data><CHCK> <ETX>
Response:	<Status><Ident channel><CHCK><ETX>

The R/W head makes only one attempt to write a **special read only code**.



Note!

The <FixLen> of IDC-...-1K read/write tags is always 6 bytes.

Enhanced program special read only code (EP):

Command:	EP <Ident channel><FixLen><Data><CHCK> <ETX>
Response:	<Status><Ident channel><CHCK><ETX>

The R/W head attempts to write a **special read only code** until successful. After each successful write, the head sends the response and then switches to continuous reading. Then the R/W head reads the same data carrier until it has left the detection range or a new data carrier appears within the detection range. The command then starts again with write attempts.

The status '05h' (read/write command) is output when the data carrier leaves the detection range or if the data carrier is not yet within the detection range when the command is executed.

If two data carriers enter the read range one immediately after the other, the status '05h' is not issued between the two readings.



Note!

The <FixLen> of IDC-...-1K read/write tags is always 6 bytes.

Initialize data carrier (SI):

Command:	SI <Ident channel><CHCK><ETX>
Response:	<Status><Ident channel><Data><CHCK><ETX>

This command allows conventional reading and writing of IDC-...-1K read/write tags that were configured using the **EP** or **SP** commands.

Extended commands for type IQC-... read/write tags.

Single write words with lock (SL)

Command:	SL <Ident channel><WordAddr><WordNum><Data> <CHCK><ETX>
Response:	<Status><Ident channel><CHCK><ETX>

This command is the same as a normal write command. The data is write-protected at the end of the write process, provided the data carriers offer this function.

This applies for 13.56 MHz data carriers of the type 21, 22, 24, 33 and 35 as well as for LF data carriers IDC-...-1K. Write protection is only activated for memory blocks involved in the write process. Data can continue to be written to all other memory blocks.

The R/W head makes one attempt to write <WordNum> 32-bit words from the address <WordAddr>.

Enhanced write words with lock (EL)

Command:	EL <Ident channel><WordAddr><WordNum><Data> <CHCK><ETX>
Response:	<Status><Ident channel><CHCK><ETX>

This command is the same as a normal write command. The data is write-protected at the end of the write process, provided the data carriers offer this function.

This applies for 13.56 MHz data carriers of the type 21, 22, 24, 33 and 35 as well as for LF data carriers IDC-...-1K. Write protection is only activated for memory blocks involved in the write process. Data can continue to be written to all other memory blocks.

The R/W head repeatedly attempts until successful to write <WordNum> 32-bit words from the address <WordAddr>. After each successful write, the head sends the response and then switches to continuous reading. Then the R/W head reads the same data carrier until it has left the detection range or a new data carrier appears within the detection range. The command then starts again with write attempts.

The status '05h' is only output when a data carrier leaves the detection range or is not yet within the detection range. If two data carriers enter the read range one immediately after the other, the status '05' is not issued between the two readings.

Extended commands for IQH2-... read/write heads

Read Parameters

The RP command reads configuration parameters from the read/write head.

Command:	RP <ChanNo> <SystemCode> <ParamTyp> <DataLength> <Data> <CHCK> <ETX>
Response:	<Status> <ChanNo> <Data> <CHCK> <ETX>

<SystemCode> = U_{ASCII} for IUH-*

<ParamTyp> = 2 bytes ASCII

<DataLength> = Length of <Data> in command, 2 bytes binary

<Data> = Optional additional information

Example:

RP1UE5.00.00 outputs the number of unsuccessful read attempts until status 5.

Syntax

RP <SystemCode><ParamTyp>

Write Parameters

Command WP writes configuration parameters to the read/write head.

Command: WP <ChanNo> <SystemCode> <ParamTyp> <DataLength> <Data>
<CHCK> <ETX>

Response: <Status> <ChanNo> <CHCK> <ETX>

<SystemCode> = U_{ASCII} for IUH-*

<ParamTyp> = 2 bytes ASCII

<DataLength> = Length of <Data>, 2 bytes binary

<Data> = Optional additional information

Example:

WP1UE5.00.01.05 sets the number of unsuccessful read attempts to status 5 on 5 attempts.

Syntax

WP <SystemCode><ParamTyp><Length>
><Value>

IQH2-...: <SystemCode> = 'Q' ASCII (51_h)

<ParamTyp> = 'K1' ASCII (4B_h 31_h)

RP: reads the key (12 characters ASCII from 0 ... F) from the transponder and the read head

WP: writes the key (12 characters ASCII from 0 ... F) into the read head

Default key = 'FF FF FF FF FF FF' ASCII
(46_h46_h46_h46_h46_h46_h46_h46_h46_h46_h46_h46_h)

IUH-...: See handbook of the read / write head

7.4 Legend

<OldPW>	: 4 bytes HEX, old password
<Battery condition 1>	: 1 byte, first digit of battery status (percentage, decimal, ASCII encoded).
<Battery condition 2>	: 1 byte, second digit of battery status (percentage, decimal, ASCII encoded).
<Battery condition 3>	: 1 byte, third digit of battery status (percentage, decimal, ASCII encoded).
<baud>	: Baud rate: 2400, 4800, 9600, 19200, 38400 (bit/s)
<ByteNum>	: 2 ASCII bytes, length of <IDCode>; System MV: 4 characters (04h) System IQ: 8 characters (08h)
<CHCK>	: 1 byte HEX, 8-bit check sum with the addition of all preceding characters, without overrun.
<ConfAddr>	: 1 ASCII character, word starting address in configuration area of data carrier. The following applies for IPC03: '1' = Protection Word '2' = Control Word
<CR>	: 1 ASCII character, 13d, carriage return
<Data>	: <WordNum> times 4 bytes. When communicating a word, the highest value byte is transferred first and the lowest value byte last.
<ETX>	: 1 ASCII character, 03d, end of text
<F>	: 1 bit, multiplex mode, 0 (0b): Mode off, 1 (1b): Mode on
<Fill Sign>	: 1 ASCII character
<FixLen>	: 2 ASCII characters from '0' to 'F', length of the read only code in bytes,
<FixType>	: 2 ASCII characters, for example: '02' for IPC02
<IDCode>	: 4 bytes, 6 bytes or 8 bytes (depending on the tag type)
<Ident channel>	: 1 ASCII character, (channel '1', '2', '3', '4', 'x') 'x' = all connected channels
<LkName>	: n ASCII characters (depending on the type designation)
<LF>	: 1 ASCII characters, 10d, line feed
<Mode>	: 1 ASCII character, '0' Configuration store off '1': Configuration store on
<Model type>	: Product order code: IC-KP-R2-V1
<Month>	: 2 ASCII bytes, hexadecimal encoding, 01 ... 0C (01=January, 0C=December)
<NewPW>	: 4 bytes HEX, new password
<P>	: 1 bit, password mode, 0 (0b): Mode off, 1 (1b): Mode on
<Part no.>	: Article number, 6 ASCII characters '0' to '9'
<PW>	: 4 bytes HEX, password
<Sensor channel>	: 1 ASCII character in trigger mode ('3', '4')
<Status>	: 1 ASCII character (see chapter 7.5)
<SW no.>	: Application software number
<SW date>	: Application software version date
<TagType>	: 2 ASCII characters, for example: '02' for IPC02

- <Timeout> : 1 to 3 ASCII characters
Timeout of interface in (0 ... 100) x 100 ms, an error message is sent after this time runs out.
'0' deactivates the timeout
- <Trigger mode> : 1 ASCII character
'0': Trigger mode off
'1': Trigger mode on
'2': Trigger mode inverted
- <WordAddr> : 4 ASCII characters, word start address in the data carrier, range from '0000h' to 'FFFFh', depending on tag type.
- <WordNum> : 2 ASCII characters, number of words to be read or written, range from '00' to '20' (128 bytes) or '00' to '1D' (116 bytes) for IPC03 ... data carriers.
- <Year> : 2 bytes ASCII, hexadecimal encoding, 00h ... 3h

7.5 Fault/status messages

Status	Meaning
0	The command has been executed without error.
1	The command is processing.

Error messages triggered by the identification system

Status	Meaning
1	Reserved
2	Switch-on message, reset has been executed.
3	Reserved
4	Incorrect or incomplete command or parameter not in the valid range.
5	No data carrier in the detection range.
6	Hardware error, e.g. error during self-test or read/write head defective.
7	Internal device error.
8	Reserved
9	The parameterized data carrier type is not compatible with the connected read head.
A	There are several transponders in the detection range (UHF).
B	Reserved
C	Reserved
D	Reserved
E	The internal cache is full.
F	Reserved



8 Technical Specifications

8.1 Dimensions

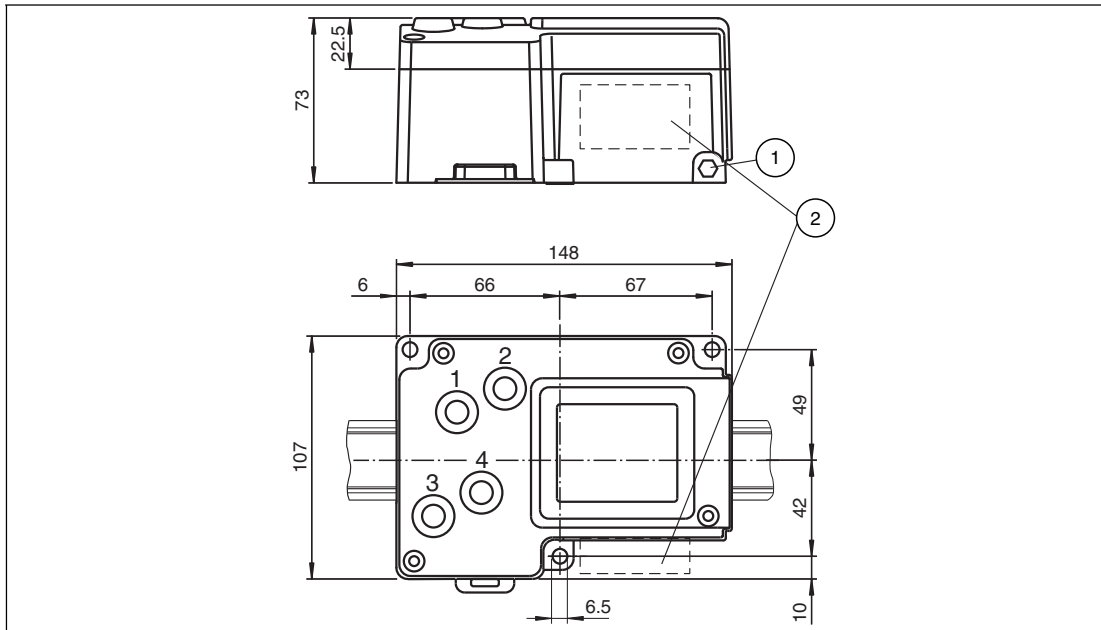

- 1 Ground
- 2 Connector array

8.2 General data

General data

Number of R/W heads	max. 4 alternatively 2 R/W heads and 2 trigger sensors
---------------------	---

Displays/controls

LEDs 1, 2, 3, 4	Status display for R/W heads green: Command to R/W head active yellow: Approx. 1 second if command executed successfully
LED PWR/ERR	green: Power on red: Hardware error
LED UL	green: Interface OK red: Fault
LED TxD	green: Data is transferred
LED RxD	green: Data is received
LC Display	Two-line multifunction display with 12 characters per line Configuration of the control interface and display of connected R/W heads as additional pictograms Simple, direct command input and addressing possible
Buttons	4 buttons: ESC, up, down and return

Electrical data

Rated operational voltage U_e	20 ... 30 V DC , PELV
Ripple	≤ 10 % at 30 V DC
Current consumption	≤ 2 A incl. R/W heads
Power consumption P_0	3.5 W without R/W heads
Galvanic isolation	Basic insulation in accordance with DIN EN 50178, rated insulation voltage 50 V _{eff}

Interface

Physical	RS 232
Protocol	ASCII
Transfer rate	1200; 2400; 4800; 9600; 19200; 38400 bits/s

Conformity

Electromagnetic compatibility	EN 61000-6-2, EN 61000-6-4,
Degree of protection	EN60529

Ambient conditions

Ambient temperature	-25 ... 70 °C (248 ... 343 K)
Storage temperature	-40 ... 80 °C (243 ... 353 K)
Climate conditions	Max. air humidity 96 % Salt spray resistant to EN 60068-2-52
Shock and impact resistance	Oscillation (sine): 5 g, 10 ... 1000 Hz to EN 60068-2-6 Shock (half-sine): 30 g, 11 ms to EN 60068-2-27

Mechanical data

Degree of protection	IP67 in accordance with EN 60529
Connection	R/W heads: Shielded, 4-pin, M12 connector Power supply M12 connector Ground: M6 grounding screw Serial: 5-pin M12 connector
Housing material	Aluminum, powder-coated
Mounting	Snap on to 35 mm DIN mounting rail or screw mounting
Weight	Approx. 1000 g

9 Troubleshooting

9.1 Fault location

Fault source	Possible cause	Remedy
The operating voltage LED (PWR/ERR) does not light up.	Power supply is interrupted.	Ensure that the power supply is connected to a 24 V DC source.
The LED on the M12 plug lights up red.	The polarity of the screw terminal type M12 socket is reversed.	Ensure that the connection layout is correct.
The icon in the display (e.g. IPH1) does not appear even though the R/W head is connected to port 1.	The cable is defective or not connected correctly.	Check the cable and repair if necessary.
	The R/W head is defective.	Check the R/W head and repair if necessary.
A read command (e.g. SR ...) gives the status 4 even though the syntax is correct.	An incorrect tag type is selected for the relevant channel (e.g. IPC02). The read commands only function with data carriers and not with code carriers.	Preset the correct tag type (e.g. PC03) or "Autodetect" using the CT ... command or via the display (IDENTControl .../ Config Channels).
The LEDs in the reading head and the IPHx icon on the IDENTControl display are flashing.	The connected reading head does not support the preset tag type.	Select a tag type that the reading head supports.
The SG or EG command (Get configuration) gives the status 4 even though the syntax is correct.	IPC03 is not selected for the relevant channel. The configuration commands only function if the data carrier IPC03 is selected and not in Autodetect mode.	Preset the tag type IPC03 using the CT... command or via the display (IDENTControl.../ Config Channels).

This table will be updated and extended if necessary. Visit www.pepperl-fuchs.de to download the latest version of the manual.

10 ASCII table

hex	dec	ASCII	hex	dec	ASCII	hex	dec	ASCII	hex	dec	ASCII
00	0	NUL	20	32	Space	40	64	@	60	96	'
01	1	SOH	21	33	!	41	65	A	61	97	a
02	2	STX	22	34	"	42	66	B	62	98	b
03	3	ETX	23	35	#	43	67	C	63	99	c
04	4	EOT	24	36	\$	44	68	D	64	100	d
05	5	ENQ	25	37	%	45	69	E	65	101	e
06	6	ACK	26	38	&	46	70	F	66	102	f
07	7	BEL	27	39	'	47	71	G	67	103	g
08	8	BS	28	40	(48	72	H	68	104	h
09	9	HT	29	41)	49	73	I	69	105	i
0A	10	LF	2A	42	*	4A	74	J	6A	106	j
0B	11	VT	2B	43	+	4B	75	K	6B	107	k
0C	12	FF	2C	44	,	4C	76	L	6C	108	l
0D	13	CR	2D	45	-	4D	77	M	6D	109	m
0E	14	SO	2E	46	.	4E	78	N	6E	110	n
0F	15	SI	2F	47	/	4F	79	O	6F	111	o
10	16	DLE	30	48	0	50	80	P	70	112	p
11	17	DC1	31	49	1	51	81	Q	71	113	q
12	18	DC2	32	50	2	52	82	R	72	114	r
13	19	DC3	33	51	3	53	83	S	73	115	s
14	20	DC4	34	52	4	54	84	T	74	116	t
15	21	NAK	35	53	5	55	85	U	75	117	u
16	22	SYN	36	54	6	56	86	V	76	118	v
17	23	ETB	37	55	7	57	87	W	77	119	w
18	24	CAN	38	56	8	58	88	X	78	120	x
19	25	EM	39	57	9	59	89	Y	79	121	y
1A	26	SUB	3A	58	:	5A	90	Z	7A	122	z
1B	27	ESC	3B	59	;	5B	91	[7B	123	{
1C	28	FS	3C	60	<	5C	92	\	7C	124	
1D	29	GS	3D	61	=	5D	93]	7D	125	}
1E	30	RS	3E	62	>	5E	94	^	7E	126	~
1F	31	US	3F	63	?	5F	95	_	7F	127	DEL

FACTORY AUTOMATION – SENSING YOUR NEEDS



Worldwide Headquarters

Pepperl+Fuchs GmbH
68307 Mannheim · Germany
Tel. +49 621 776-0
E-mail: info@de.pepperl-fuchs.com

USA Headquarters

Pepperl+Fuchs Inc.
Twinsburg, Ohio 44087 · USA
Tel. +1 330 4253555
E-mail: sales@us.pepperl-fuchs.com

Asia Pacific Headquarters

Pepperl+Fuchs Pte Ltd.
Company Registration No. 199003130E
Singapore 139942
Tel. +65 67799091
E-mail: sales@sg.pepperl-fuchs.com

www.pepperl-fuchs.com

 **PEPPERL+FUCHS**
SENSING YOUR NEEDS