

**NON HAZARDOUS LOCATION**

**HAZARDOUS LOCATION**

Class I, Div. 1, GROUPS A, B, C, D  
Class I, Zone 0, Ex ia IIC T6  
Class I, Div. 2, Zone 2  
Class II, Div. 1, GROUPS E, F, G  
Class III, Div. 1

F'-Type Housing:  
IS / I, II, III / 1 / A, B, C, D, E, F, G

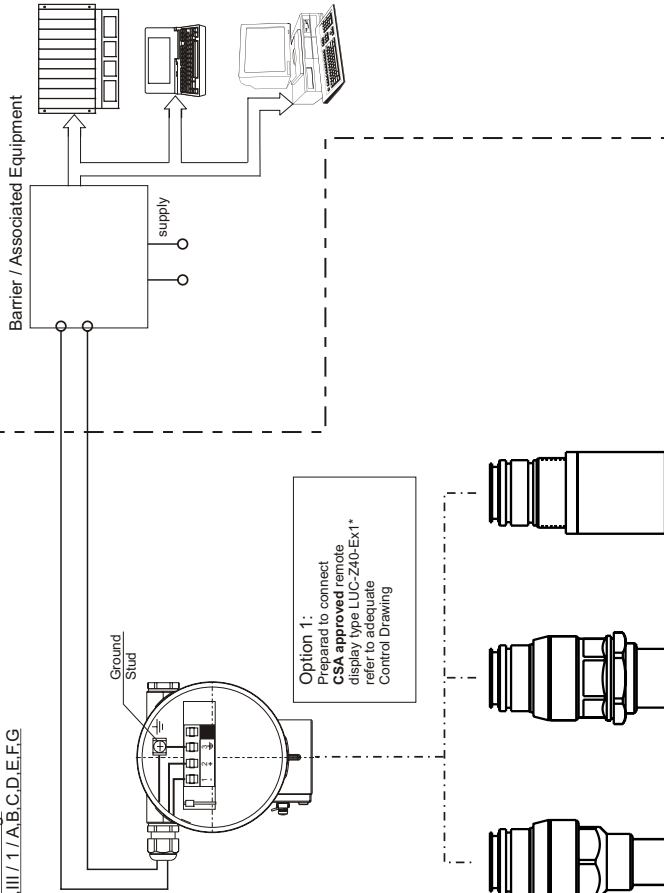

Option 1:  
Prepared to connect  
CSA approved remote  
display type LUC-Z40-Ext\*  
refer to adequate  
Control Drawing

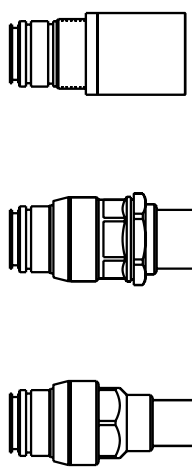

LUC-M10- LUC-M20- LUC-M40-

Area of application:

The compact instruments are suitable for use in areas subject to explosion caused by gases, vapours or mists.

Permissible ambient temperature:  
Electronic: F'-Type enclosure -40 ... +80 °C

Type	Type of sensor	Operation temperature [°C]
LUC-M10-	1 1/2"-sensor	-40 to +80
LUC-M20-	2"-sensor	-40 to +80
LUC-M40-	3"-sensor	-40 to +80

**ENTITY-Concept**

INTRINSICALLY SAFE (Ex ia), CLASS I, DIV. 1, GROUPS A, B, C, D or Ex ia IIC  
HAZARDOUS LOCATION INSTALLATION

- Control room equipment may not use or generate over 250 Vrms.
- Install per the Canadian Electrical Code.
- Warning: Substitution of components may impair intrinsic safety. Avertissement: La substitution de composants peut compromettre la sécurité intrinsèque.
- Ex ia IS defined as intrinsically safe / sécurité intrinsèque.
- For entity installation use CSA certified safety barrier or other associated equipment that satisfy the following conditions: with  $U_0/V_{oc} \leq U_{Vmax}$ ,  $I_0/I_{sc} \leq I_{Imax}$ ,  $C_0/C_{0c} \geq C_0 + C_{0table}$ ,  $L_0/L_{0a} \leq L_1 + L_{0table}$

$U_0/V_{oc}$ (V) or 17.5 24	$I_0/I_{sc}$ (mA) 500 250	$P/P_{max}$ (W) 5.5 1.2	$C_0$ (nF) $\leq 5$ $\leq 5$	$L_1$ ( $\mu$ H) $\leq 10$ $\leq 10$
--------------------------------------	---------------------------------	-------------------------------	------------------------------------	--

- For system installation use: CSA certified safety barriers as follows:  
(a) 28 V / 300  $\Omega$  + Ground or  
(b) 28 V / 300  $\Omega$  + 28 V / Diode or  
(c) 28 V / 300  $\Omega$  + 10 V / 50  $\Omega$
- Use supply wires suitable for 5 K above surrounding ambient. Utiliser des fils d'alimentation qui conviennent a une température de 5 K au-dessus de la température ambiante.
- Install barrier/ associated equipment in accordance with manufacturer's instruction.
- The polarity for connecting + (2) and - (1) is of no importance due to an internal rectifier.

CLASS I, DIV. 2, GROUPS A, B, C, D, or Ex nC IIC AND DIP FOR CLASS II AND III, DIV. 1, GROUPS E, F, G  
HAZARDOUS LOCATION INSTALLATION

- Depending on Location install per Canadian Electrical Code (CEC) using wiring methods described in Rule 18-156 or Rule 18-202 or Rule 18-302. Intrinsic safety barrier not required. Max. supply voltage 32V. For T-code see table.
- Warning: Explosion Hazard - Do not disconnect equipment unless power has been switched off or the area is known to be non-hazardous. Avertissement: Risque d'explosion - Avant de déconnecter l'équipement, couper le courant ou s'assurer que l'emplacement est désigné non dangereux. Warning: Explosion hazard - substitution of components may impair suitability for Class I, Div. 2. Avertissement: Risque d'explosion - la substitution de composants peut rendre ce matériel inacceptable pour les emplacements de Classe I, Div. 2.

For CLASS II and III: Div.1:  
WARNING: Keep cover tight unless power has been switched off or the area is known to be non-hazardous.

Temperature class with / without Display VU 331 T6 T5 T4	Permissible maximum medium temperature at the sensors +60 °C +80 °C +80 °C	Permissible maximum ambient (T <sub>a</sub> ) of electronic compartment (F'-Type enclosure)	
		LUC-M10- +60 °C +75 °C +80 °C	LUC-M20- +60 °C +75 °C +80 °C

For Installation acc. -FISCO-Concept see sheet 3.

**16-519CS-12 2/7**

**LUC-M10, LUC-M20, LUC-M40**  
CSA control drawing (F\*\*, ENTITY model,  
PROFIBUS PA or FOUNDATION Fieldbus)



71032963

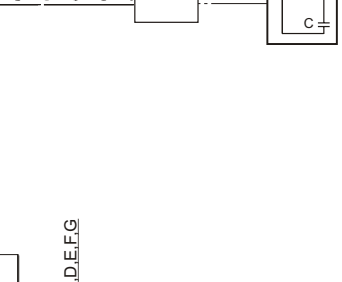
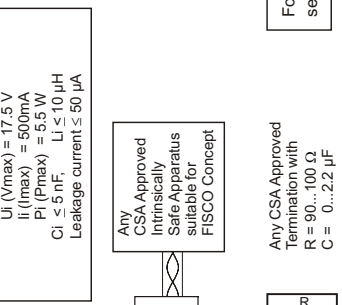
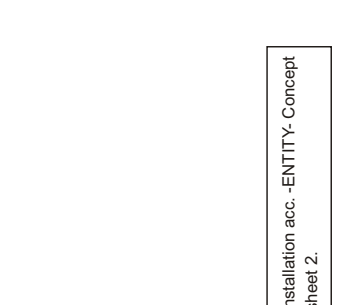
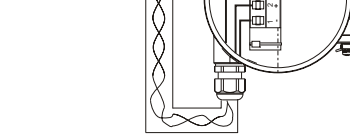
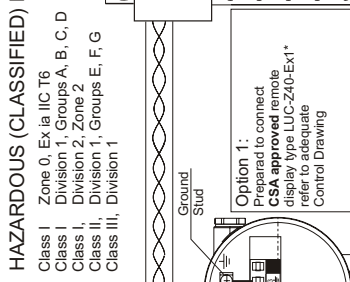
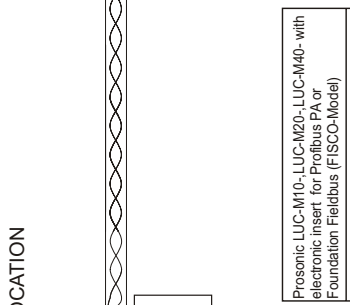
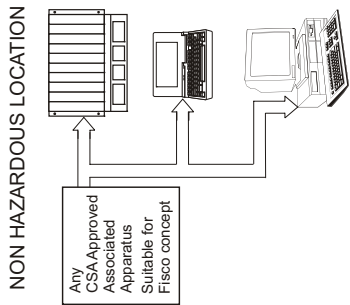

**FISCO-Concept**

The FISCO Concept allows interconnection of intrinsically safe apparatus to associated apparatus not specifically examined in such combination.

The criteria for interconnection is that the voltage (Ui), the current (Ii) and the power (Pi) which intrinsically safe apparatus can receive and remain intrinsically safe, considering faults, must be equal or greater than the voltage (Uo), the current (Io) and the power (Po) levels which can be delivered by the associated apparatus, considering faults and applicable factors. In addition, the maximum unprotected capacitance (Ci) and inductance (Li) of each apparatus (other than the termination) connected to the fieldbus must be less than or equal to 5 nF and 10 µH respectively.

In each segment only one active device, normally the associated apparatus, is allowed to provide the necessary energy for the fieldbus system.

The voltage Uo of the associated apparatus has to be limited to the range of 14V to 24V d.c. All other equipment connected to the bus cable has to be passive, meaning that they are not allowed to provide energy to the system, except to a leakage current of 50 µA for each connected device.

Separately powered equipment needs a galvanic isolation to assure that the intrinsically safe fieldbus circuit remains passive.

The cable used to interconnect the devices needs to have the parameters in the following range:

loop resistance R: 15 ... 150 Ω/km  
 inductance per unit length L: 0.4 ... 1 mH/km  
 capacitance per unit length C: 80 ... 200 nF/km  
 C = C line/line + 0.5 C line/screen, if both lines are floating or  
 C = C line/line + C line/screen, if the screen is connected to one line  
 length of spur cable: ≤ 30 m  
 length of trunk cable: ≤ 1 km  
 length of splice: ≤ 1 m

At each end of the trunk cable an approved infallible line termination with the following parameters is suitable:

R = 90 ... 100 Ω  
 C = 0 ... 2.2 µF

One of the allowed terminations might already be integrated in the associated apparatus.

The number of passive devices connected to the bus segment is not limited due to U.S. reasons. If the above rules are respected, up to a total length of 1000 m (sum of the length of trunk cable and all spur cables), the inductance and capacitance of the cable will not impair the intrinsic safety of the installation.

**Notes:**

**INTRINSICALLY SAFE (Ex ia), CLASS I, DIV. 1, GROUPS A, B, C, D or Ex ia IIC HAZARDOUS LOCATION INSTALLATION**

- The maximum non-hazardous area voltage must not exceed 250 V.
- The installation must be in accordance with the Canadian Electrical Code (CEC).
- Warning: Substitution of components may impair intrinsic safety.  
Avertissement: La substitution de composants peut compromettre la sécurité intrinsèque.
- CSA Certified apparatus must be installed in accordance with manufacturer instructions.
- CSA Certified associated apparatus must meet the following requirements:  
 $U_o \leq U_i$  and  $I_o \leq I_i$  and  $P_o \leq P_i$
- Be aware of multiple earthing of the screen. The screen must be connected in accordance with the CEC.
- Caution: Use only supply wires suitable for 5K above surrounding temperature.  
Utiliser des fils d'alimentation qui conviennent à une température de 5K au-dessus de la température ambiante.
- The polarity for connecting + (2) and - (1) is of no importance due to an internal rectifier.

**CLASS I, DIV. 2, GROUPS A, B, C, D or Ex nC IIC AND DIP FOR CLASS II AND III, DIV. 1, GROUPS E, F, G HAZARDOUS LOCATION INSTALLATION**

- Depending on Location install per Canadian Electrical Code (CEC) using wiring methods described in Rule 18-156 or Rule 18-202. Intrinsic safety barrier not required. Max. supply voltage 32 V. For T-code see table.
- Warning: Explosion Hazard - Do not disconnect equipment unless power has been switched off or the area is known to be non-hazardous.  
Avertissement: Risque d'explosion - Avant de déconnecter l'équipement, couper le courant ou s'assurer que l'emplacement est désigné non dangereux.  
Warning: Explosion hazard - substitution of components may impair suitability for Class I, Div. 2.  
Avertissement: Risque d'explosion - la substitution de composants peut rendre ce matériel inacceptable pour les emplacements de Classe I, Div. 2.

For CLASS II and III; DIV. 1:  
 WARNING: Keep cover tight unless power has been switched off  
 or the area is known to be non-hazardous.

**Area of application:**  
 The compact instruments are suitable for use in areas subject to explosion caused by gases, vapours or mists.  
 Permissible ambient temperature:  
 Electronic: F\*-Type enclosure -40 ... +80 °C

Type	Type of sensor	Operation temperature [°C]
LUC-M10-	1 1/2"-sensor	-40 to +80
LUC-M20-	2"-sensor	-40 to +80
LUC-M40-	3"-sensor	-40 to +80

Temperature class with / without Display VU 331	Permissible maximum medium temperature at the sensors	Permissible maximum ambient (T <sub>a</sub> ) of electronic compartment (F*-Type enclosure)
T5	+60 °C	LUC-M20- +60 °C
T6	+80 °C	LUC-M40- +60 °C
T4	+80 °C	+75 °C +80 °C

16-519CS-12 3/7

LUC-M10, LUC-M20, LUC-M40  
 CSA control drawing (F\*\*, FISCO model,  
 PROFIBUS PA or FOUNDATION Fieldbus)



71032963