

MANUAL

IPT*-FP with U-P6-R4 **Read/write station with** **addressable serial Interface**

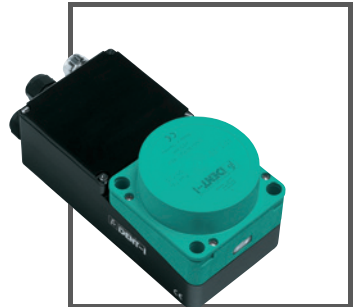

CE

1	Introduction.....	4
2	Declaration of conformity	5
2.1	CE conformity	5
3	Safety	6
3.1	Symbols relevant to safety	6
3.2	Intended use.....	6
3.3	General safety instructions.....	6
4	Product description.....	7
4.1	Product family	8
4.1.1	Code/data carrier	8
4.2	Range of application	9
4.3	Delivery package.....	9
4.4	Display and controls	10
4.5	Interfaces and connections	11
5	Installation.....	12
5.1	Storage and transport	12
5.2	Unpacking	12
5.3	EMC concept.....	12
5.4	Earth connection	13
6	Commissioning.....	14
6.1	General information on commissioning	14

6.2	Commands	14
6.2.1	Command overview.....	15
6.2.2	System commands.....	17
6.2.3	Read/write commands.....	20
6.2.4	IPC03 configuration commands.....	22
6.2.5	IPC03 password mode.....	27
6.2.6	Write fixcode.....	28
6.2.7	Legend.....	29
6.2.8	Status and error messages.....	29
7	Technical specifications	30
7.1	Read/write station IPT*-FP.....	30
7.2	Read/write distances IPT*-FP.....	31
7.3	U-P6-R4 lower section.....	32

1 Introduction

Congratulations

You have chosen a device manufactured by Pepperl+Fuchs. Pepperl+Fuchs develops, produces and distributes electronic sensors and interface modules for the market of automation technology on a worldwide scale.

Before you install this device and put it into operation, please read the operating instructions thoroughly. The instructions and notes contained in this operating manual will guide you step-by-step through the installation and commissioning to ensure the trouble-free usage of this product. This is useful to you, because with this you:

- support the safe operation of the device
- can utilize the device's entire range of functions
- reduce faulty operation and the associated errors
- reduce costs from downtime and incidental repairs
- increase the effectiveness and operating efficiency of your plant.

Store this operating manual somewhere safe in order to have it available for future work on the device.

Directly after opening the packaging, please ensure that the device is intact and that the package is complete.

Symbols used

The following symbols are used in this manual:



Note!

This symbol draws your attention to important information.



Handling instructions

You will find handling instructions beside this symbol

Contact

If you have any questions about the device, its functions, or accessories, please contact us at:

Pepperl+Fuchs GmbH
Lilienthalstraße 200
68307 Mannheim
Telephone: +49 621 776-4411
Fax: +49 621 776-274411
E-Mail: fa-info@pepperl-fuchs.com

2 Declaration of conformity

2.1 CE conformity

This product was developed and manufactured under observance of the applicable European standards and guidelines.



Note!

A declaration of conformity can be requested from the manufacturer.

3 Safety

3.1 Symbols relevant to safety



Danger!

This symbol indicates a warning about a possible danger.

In the event the warning is ignored, the consequences may range from personal injury to death.



Warning!

This symbol indicates a warning about a possible fault or danger.

In the event the warning is ignored, the consequences may course personal injury or heaviest property damage.



Caution!

This symbol warns of a possible fault.

Failure to observe the instructions given in this warning may result in the devices and any connected facilities or systems develop a fault or fail completely.

3.2 Intended use

Together, the devices IPT*-FP and U-P6-R4 of the inductive identification system IDENT-I system P comprise a read/write station.

Always operate the device as described in these instructions to ensure that the device and connected systems function correctly. The protection of operating personnel and plant is only guaranteed if the device is operated in accordance with its intended use.

3.3 General safety instructions

Only instructed specialist staff may operate the device in accordance with the operating manual.

Independent interventions and separate modifications are dangerous and will void the warranty and exclude the manufacturer from any liability. If serious faults occur, stop using the device. Secure the device against inadvertent operation. In the event of repairs, send the device to Pepperl+Fuchs.

The connection of the device and maintenance work when live may only be carried out by a qualified electrical specialist.

The operating company bears responsibility for observing locally applicable safety regulations.

Store the not used device in the original packaging. This offers the device optimal protection against impact and moisture.



Note!

Electronic waste is hazardous waste. Observe local disposal regulations.

4 Product description

The brand name IDENT-I System P represents a complete identification system. The read/write station consists of the read/write head IPT*-FP (standard version: IPT1-FP) and the lower section U-P6-R4 with addressable serial interface RS485. With the use of 125 kHz technology, the system is extensively open for the implementation of other components.



4.1 Product family

The inductive identification system IDENT-I system P from Pepperl+Fuchs offers various possible combinations of individual components.

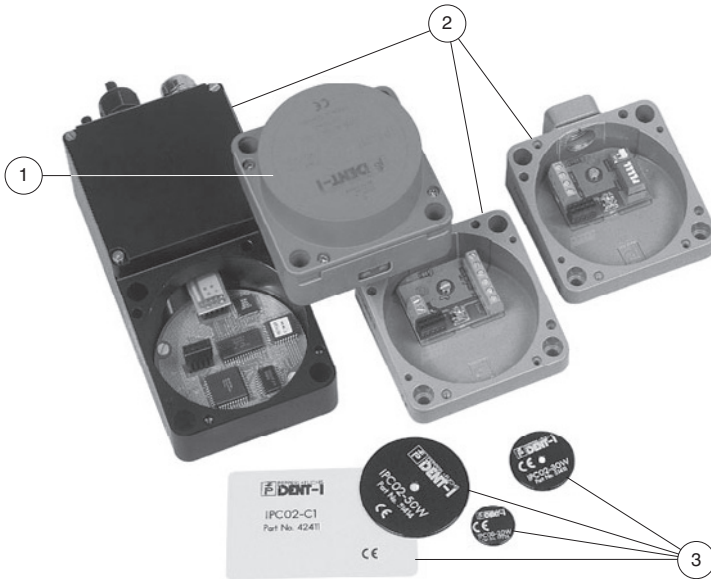

- 1 Read/write station
- 2 Lower sections
- 3 Code/data carrier



Note!

Detailed information on the components of the identification system IDENT-I system P can be found in the sensor systems 1 catalog.

4.1.1 Code/data carrier

A wide assortment of designs is available for the inductive 125 kHz code and data carriers. Data carriers are available for temperatures up to 300 °C (max. 5 min) in chemical-resistant housings for installation in metal and in protection class IP68/IP69K. IPC02-... code carriers offer 40-bit fixcode. IPC03-... data carriers have 928 bits of freely programmable memory and a non-variable fixcode of 32 bits. The storage area of the IPC03-... can be protected against unauthorized read and write. 40-bit fixcodes that can be freely determined can be generated with IPC11-... code carriers. These fixcodes can be generated one time permanently or they can be modifiable.

205843-2/09-03

4.2 Range of application

The system is suited for the following applications:

- Automation
- Material flow control in production
- Acquisition of operating data
- Access control
- Identification of e.g. storage vessels, pallets, work piece carriers, refuse containers, tanks, containers, etc.

4.3 Delivery package

IPT*-FP contains:

- 1 Read/write head
- CD with documentation (incl. this manual)

U-P6-R4¹ contains:

- Lower section
- 1 cover
- 2 ring terminals
- 1 earthing screw
- 1 serrated lock washer
- 1 sticker

¹ The lower section must be ordered separately.

4.5 Interfaces and connections

The following interfaces and connections are located on the lower section U-P6-R4:

incoming interface

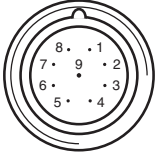

connector

- | | |
|---|-------|
| 1 | DO1 |
| 2 | /DO1 |
| 3 | DI1 |
| 4 | /DI1 |
| 5 | GND |
| 6 | PE |
| 7 | +24 V |
| 8 | 0 V |
| 9 | |

outgoing interface

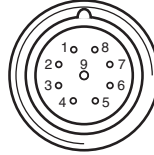

socket

- | | |
|---|-------|
| 1 | DO2 |
| 2 | /DO2 |
| 3 | DI2 |
| 4 | /DI2 |
| 5 | GND |
| 6 | PE |
| 7 | +24 V |
| 8 | 0 V |
| 9 | /RBST |

5 Installation

5.1 Storage and transport

For storage and transport purposes, package the unit using shockproof packaging material and protect it against moisture. The best method of protection is to package the unit using the original packaging. Furthermore, ensure that the ambient conditions are within permissible range.

5.2 Unpacking

Check the product for damages while unpacking. In the event of damage to the product, inform the post office or parcel service and notify the supplier.

Check the package contents with your purchase order and the shipping documents for:

- Delivery quantity
- Device type and version in accordance with the type plate
- Accessories
- Manual/manuals

Retain the original packaging in case the device must be stored or shipped again at a later date.

Should you have any questions, please direct them to Pepperl+Fuchs.

5.3 EMC concept

The screening of cables provides for the discharge of electromagnetic interference. When screening a cable, both sides of the screen must be connected to the earth with low resistance and low inductance.



Note!

If cables with double screening are used, e.g. wire meshing and metalized foil, the screens must be connected together at the ends, with low resistance, when making up the cable.

Power supply cables are the source of much interference, e.g. the starting current of 3-phase electric motors. For this reason, the parallel laying of power supply cables with data and signal cables should be avoided, particularly in the same cable duct.



Connect screening with the PG cable gland of the lower section

In order to connect the screening with the PG cable gland on the lower section and in so doing satisfy the EMC requirements in accordance with DIN VDE 0871/6.78, the following steps must be carried out:

1. Strip the outer sheathing of the cable end over a length of approx. 10 mm.
2. Lightly flare the screen (2).
3. Slide the screen (2) over the cone (3).
4. Pull the seal insert (1) over the screen (2) and cone (3).
5. Screw on the PG cable gland.

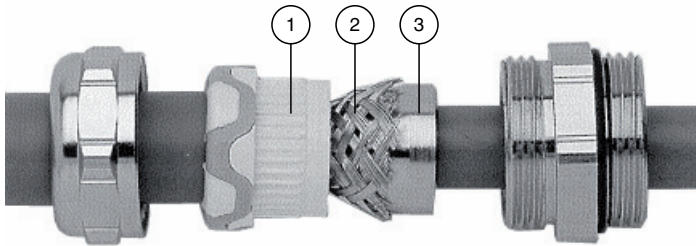

5.4 Earth connection

The internal PE connection of the lower section is conductively connected with the housing. However, from the point of view of screening, connection to the outside of the housing is preferable.

The external earth connection of the lower section is located lower left, adjacent to the cable entries. The PE conductor is screwed to the housing with a crimp connector. In order to guarantee safe earthing, the serrated washer must be mounted between the crimp connector and the housing.

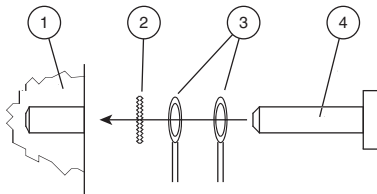

- 1 Housing
- 2 Serrated lock washer
- 3 Crimp connector
- 4 Lock screw

A cross-section of at least 4 mm² is recommended for the PE conductor lead.

6 Commissioning

6.1 General information on commissioning



Warning!

Before commissioning, ensure that the plant is not in danger relating to device malfunction, e.g. from uncontrollable triggered processes.



Note!

Before commissioning, check once again that the connections are correct.

After connecting the supply voltage, the green LED must illuminate. Configure the read/write station with the described system commands.

The factory set transfer rate is 9600 baud and no timeout. "Autodetect" is set as the data carrier type.

6.2 Commands

To operate the read/write station, commands are sent to the station. The station reacts to them – with the exception of the reset command – by sending an acknowledgement of receipt. Data is retrieved with get data commands.

The commands contain the number of the read/write station <KopfNr>, so that individual stations can be addressed in a multidrop connection.

To avoid a number of stations communicating simultaneously, the master or host must wait for a response after sending a command (other than the reset command). This takes place in a maximum of 250 ms. If the master does not receive a response after this time, no read/write station with the requested head number is functional.

All of the system settings received by the interface are stored in a non-volatile manner. They are automatically active after a reset.

All commands conclude with the characters <CHCK> = "checksum" and <ETX> = "end of text". This serves to secure the data of the serial transfer. For simplified usage with a standard terminal, the read/write station also accepts a #<CR> [<LF>] in place of <CHCK> <ETX>.

6.2.1 Command overview

The commands in the list are described in detail on the following pages.

System commands

Command code		Command description	Abbreviation
240d	F0h	get data	GD
3d	03h	version	VE
2d	02h	quit	QU
4d	04h	change tag	CT
21d	15h	configure interface	CI
22d	16h	reset	RS
23d	17h	configuration store	CS

Standard read/write commands

Read data

Command code		Command description	Abbreviation
16d	10h	single read words	SR
32d	20h	auto read words	AR
48d	30h	buffered read words	BR
25d	19h	enhanced buffered read words	ER

Write data

Command code		Command description	Abbreviation
64d	40h	single write words	SW
80d	50h	auto write words	AW
96d	60h	buffered write words	BW
26d	1Ah	enhanced buffered write words	EW

Fixcode

Command code		Command description	Abbreviation
1d	1h	single read fixcode	SF
8d	8h	auto read fixcode	AF
9d	9h	buffered read fixcode	BF
29d	1Dh	enhanced buffered read fixcode	EF

Special command modes

IPC03 configuration

Command code		Command description	Abbreviation
18d	12h	single write configure	SC
19d	13h	auto write configure	AC
20d	14h	buffered write configure	BC
102d	66h	enhanced buffered write configure	EC
97d	61h	single get configuration	SG
98d	62h	auto get configuration	AG
99d	63h	buffered get configuration	BG
104d	68h	enhanced buffered get configuration	EG

Password mode with IPC03

Command code		Command description	Abbreviation
24d	18h	password mode	PM
65d	41h	password change	PC
66d	42h	password set	PS

Write fixcode

Commands for the IPC10

Command code		Command description	Abbreviation
31d	1Fh	single write fixcode	SX
100d	64h	auto write fixcode	AX
101d	65h	buffered write fixcode	BX
36d	24h	enhanced buffered write fixcode	EX

6.2.2 System commands

get data

This command retrieves the data from the read station.

Data is only available for read commands. The data component is missing for write commands.

Command: `gd <DeviceNo> <CHCK> <ETX>`
 Response: `<Status> <DeviceNo>
 <ExecCounter>{<Data>}<CHCK> <ETX>`



Note!

After a reset, a get data command returns the status "2" (switch-on message).

Version

This command transfers the software version.

Command: `ve <DeviceNo> <CHCK> <ETX>`
 Response: `<Status> <DeviceNo> (c) P+F IDENT-I
 <Type code>
 <Part no.>
 <SW no.>
 <Date> <CHCK> <ETX>`

Change Tag

This command tells the read station, which tag to communicate with. The read station status on delivery is Type "00".

Command: "ct" <DeviceNo> <TagType> <CHCK>
<ETX>

Response: <Status> <DeviceNo> <CHCK> <ETX>

The following data carrier types are currently supported:

Data carrier-type		Description P+F	Chip-Type	Access	Bits	<WordAddr>	Fixcode length [Byte]	Frequency range
High Byte	Low Byte							
'0'	'0'	Autodetect						
'0'	'2'	IPC02	Unique, EM4102 (EM microelectronic)	Fixcode	40		5	125 kHz
'0'	'3'	IPC03	EM4450 (EM microelectronic), Titan	R/W fixcode	928 32	00h ... 1Dh	4	125 kHz
'1'	'0'	IPC10	Nova (Sokymat)	R/W	40	00	-	125 kHz

With the type <TagType> = "00", mixed operation of different code/data carriers is possible. Since the read/write station for the autodetect requires a significantly longer time, only static read and write is practical in this mode. In the "autodetect" operating mode, the parameters word start address and word count are only first checked when a data carrier is read or written because the memory ranges differ for the various data carrier types. The error message "Status 4" can therefore only occur when a data carrier is before the read/write station.

Quit

The running buffered, enhanced-buffered or auto command is interrupted.

Command: "qu" <DeviceNo> <CHCK> <ETX>

Response: <Status> <DeviceNo> <CHCK> <ETX>

Configure Interface

This command sets the timeout and the baud rate. The values are stored in a non-volatile manner. A change always requires a reset to take effect.

The timeout indicates the amount of time, after which the device no longer waits for more characters in a command. After the timeout runs through, the user gets an error message. To deactivate the timeout, the time must be set to "0".

The number of data bits is always 8. A parity bit is never used.

Command: "ci" <DeviceNo> <Timeout>, <Baud>
<CHCK> <ETX>
Response: <Status> <DeviceNo> <CHCK> <ETX>

The following settings are possible:

<Timeout>: "0" ... "100" (x 100 ms, timeout in 100-ms steps)
<Baud>: "1200", "2400", "4800", "9600", "19200"

The default values are a timeout of "0" and a baud rate of "9600".

Reset

This command sets the changed system settings, e.g. timeout and baud rate, newly loaded from the non-volatile memory.

Command: "rs" <DeviceNo> <CHCK> <ETX>
Response: "2" <DeviceNo> <CHCK> <ETX>

Configuration store

If <Param> = "1", the next command entered in this setting is stored in the non-volatile memory. This command is also executed. After a reset it is automatically active again.

<Param> = "0" deletes the stored command.

Command: cs <DeviceNo> <Param> <CHCK> <ETX>
Response: <Status> <DeviceNo> <CHCK> <ETX>

6.2.3 Read/write commands

Code or data carrier	Access	Address range <WordAddr>	Data range <WordNum>	Storage size in bytes
IPC01	Read/write	0000...0017	01...18	96
IPC02	Fixcode	-	-	5
IPC03	Read/write	0000...001C	01...1D	116
IPC03	Fixcode	-	-	4
IPC10	Read/write	0	1,3	12

Single Read Words:

One attempt is made to read <WordNum> 32-bit words from the address <WordAddr> .

Command: "sr" <DeviceNo> <WordAddr> <WordNum>
<CHCK> <ETX>

Response: <Status> <DeviceNo> <CHCK> <ETX>

Auto Read Words:

An attempt is made until successful, to read <WordNum> 32-bit words from the address <WordAddr> .

Command: "ar" <DeviceNo> <WordAddr> <WordNum>
<CHCK> <ETX>

Response: <Status> <DeviceNo> <CHCK> <ETX>

Buffered Read Words:

An attempt is made until successful, to read <WordNum> 32-bit words from the address <WordAddr> . Only changing data is transferred via the interface.

Command: "br" <DeviceNo> <WordAddr> <WordNum>
<CHCK> <ETX>

Response: <Status> <DeviceNo> <CHCK> <ETX>

Enhanced Buffered Read Words:

An attempt is made until successful, to read <WordNum> 32-bit words from the address <WordAddr>. Only changing data is transferred via the interface. When a data carrier leaves the read range, the status "5" is output.

Command: "er" <DeviceNo> <WordAddr> <WordNum>
<CHCK> <ETX>

Response: <Status> <DeviceNo> <CHCK> <ETX>

Single Write Words:

One attempt is made to write <WordNum> 32-bit words from the address <WordAddr>.

Command: "sw" <DeviceNo> <WordAddr> <WordNum>
<Data> <CHCK> <ETX>

Response: <Status> <DeviceNo> <CHCK> <ETX>

Auto Write Words:

Repeated attempts are made until <WordNum> 32-bit words are written from the address <WordAddr>.

Command: "aw" <DeviceNo> <WordAddr> <WordNum>
<Data> <CHCK> <ETX>

Response: <Status> <DeviceNo> <CHCK> <ETX>

Buffered Write Words:

Repeated attempts are made until <WordNum> 32-bit words are written from the address <WordAddr>. After every successful write, the response is sent and then continuous reading ensues. Then the same data carrier is read, until it has left the read/write range or a new data carrier appears in front of the read/write head. The command then starts again from the beginning.

Command: "bw" <DeviceNo> <WordAddr> <WordNum>
<Data> <CHCK> <ETX>

Response: <Status><DeviceNo> <CHCK> <ETX>

Enhanced Buffered Write Words:

This command behaves like the Buffered Write Words command. When a data carrier leaves the read range, the status "5" is output.

Command: "ew" <DeviceNo> <WordAddr> <WordNum>
<Data> <CHCK> <ETX>

Response: <Status> <DeviceNo> <CHCK> <ETX>

Single Read Fixcode:

One attempt is made to read a fixcode.

Command: "sf" <DeviceNo> <CHCK> <ETX>

Response: <Status> <DeviceNo> <CHCK> <ETX>

Auto Read Fixcode:

An attempt is made until successful, to read a fixcode.

Command: "af" <DeviceNo> <CHCK> <ETX>
Response: <Status> <DeviceNo> <CHCK> <ETX>

Buffered Read Fixcode:

The fixcode continues to be read. Only changing data is transferred via the interface.

Command: "bf" <DeviceNo> <CHCK> <ETX>
Response: <Status> <DeviceNo> <CHCK> <ETX>

Enhanced Buffered Read Fixcode:

This command behaves like the Buffered Read Fixcode command. The status "5" is output if the code or data carrier leaves the read range.

Command: "ef" <DeviceNo> <CHCK> <ETX>
Response: <Status> <DeviceNo> <CHCK> <ETX>

6.2.4 IPC03 configuration commands



Note!

In order to be able to use these commands, the data carrier type IPC03 must be set. The configuration commands cannot be used in the autodetect mode (mixed operation, data carrier type 00)!

The storage of a type IPC03 data carrier is organized by word. Every "word" is made up of 32 bits. For the normal data range, 29 words from addresses 3 through 31 (<WordAddr> = 00_h ... 1C_h) are available.

The storage of the data carrier IPC03 is constructed in the following way:

Address	Meaning	<WordAddr>	<ConfAddr>	Note
Word 0	Password	-	-	Write only
Word 1	Protection word	-	"1"	Read/write
Word 3	Control word	-	"2"	Read/write
Word 3...31	Data range	"00"..."1C"	-	Read/write
Word 32	Device Serial Number	"1D"	-	Read only
Word 33	Device identification	"1E"	-	Read only

The IPC03 has one “protection word” and one “control word”. With the “protection word”, a read-protected and a write-protected range can be defined. For this, each start and end of a read-protected and a write-protected range can be defined. With the “control word”, various operating modes and the read range for the “default read” operating mode are set. Both words can only be accessed with the correct password.

The bits of the individual words have the following meaning:

Control word

Bit	Meaning	Byte
0...7	Read range start	0
8 ... 15	Read range end	1
16	Password protection on/off	2
17	“Read after write” operating mode on/off	
18 ... 23	Open	3
24 ... 31	Open	

Protection word

Bit	Meaning	Byte
0 ... 7	First read-protected word	0
8 ... 15	Last read-protected word	1
16 ... 23	First write-protected word	2
24 ... 31	Last write-protected word	3

With the control and protection word, it should be noted that when communicating a word, the highest value byte is transferred first and the lowest value byte last. With the entry of the read and write-protected words, the words are counted as follows:

00	Password
01	Protection word
02	Control word
03	1. Data word
04	2. Data word
...	...
1F	29. Data word

IPC03 password mode

It is possible to protect the control word and the protection word from being overwritten. Then the configuration can no longer be changed. The password mode serves this purpose.

With password mode active in the data carrier, the data range of a data carrier can only be read or written after the correct password is sent to the data carrier from the read/write head. The following must apply for this:

- The correct password is set once with the command **PS** "set password" and
- the password mode is activated with the command **PM** "set password mode".

The password in the read/write head and on the data carrier can be changed with the command **PC**.

If the password mode is deactivated, every word on the data carrier can be read and written as necessary.

In the factory default condition of the read heads and the data carrier IPC03, the password is 00000000_h. In the read head, the password is stored in a volatile manner and in the data carrier IPC03 in a non-volatile manner.

"Default read"

In the "default read" operating mode 1 or 2, words can be read very quickly, because the memory to be read is already defined on the data carrier and does not need to be communicated to the data carrier from the read/write head first.

The start and end of the read range are stored in the bytes 0 and 1 of the "control word". As soon as the data carrier is supplied with energy the data carrier sends out the data from the data range, which is defined by the read range start and end. The data range between read range start and end can be read with the read commands **SR** (single read words) and **ER** (enhanced buffered read words) when <WordAddr> is set to 0000h and <WordNum> is set to 00h.

The advantages of the "default read" operating mode lie in the readout speed. The readout of one data word (4 bytes) is twice as fast in this mode. The readout of 2 words takes approx. 1/3 less time. Starting at 3 data words there is no more time advantage since this mode is only intended for the reading of a maximum of 2 words (=8 bytes). Reading larger data ranges can lead to error messages when the read head does not respond within the planned reaction time.

Single Write Configuration:

One attempt is made to write a word in the configuration range from the address <ConfAddr> . In order to write in the configuration range, the password mode must be active.

Command:	"sc" <DeviceNo> <ConfAddr> <Data> <CHCK> <ETX>
Response:	<Status> <DeviceNo> <CHCK> <ETX>

Auto Write Configuration:

Repeated attempts are made until successful, to read a word in the configuration range from the address <ConfAddr> .

Command: "ac" <DeviceNo> <ConfAddr> <Data>
<CHCK> <ETX>

Response: <Status> <DeviceNo> <CHCK> <ETX>

Buffered Write Configuration:

One attempt is made to write a word in the configuration range from the address <ConfAddr>. After each successful write, the response is sent and the system waits until a new data carrier is within the detection range. The command then starts again from the beginning. In order to write in the configuration range, the password mode must be active.

Command: "bc" <DeviceNo> <ConfAddr> <Data>
<CHCK> <ETX>

Response: <Status> <DeviceNo> <CHCK> <ETX>

Enhanced Buffered Configuration:

This command behaves like the buffered write configuration command; the status "5" is only output when a data carrier leaves the read range.

Command: "ec" <DeviceNo> <ConfAddr> <Data>
<CHCK> <ETX>

Response: <Status> <DeviceNo> <CHCK> <ETX>

Single Get Configuration:

One attempt is made to read a word in the configuration range ("protection word" or "control word") from the address <ConfAddr>.

Command: "sg" <DeviceNo> <ConfAddr> <CHCK>
<ETX>

Response: <Status> <DeviceNo> <CHCK> <ETX>

Auto Get Configuration:

An attempt is made until successful, to read a word in the configuration range ("protection word" or "control word") from the address <ConfAddr>.

Command: "ag" <DeviceNo> <ConfAddr> <CHCK>
<ETX>

Response: <Status> <DeviceNo> <CHCK> <ETX>

Buffered Get Configuration:

An attempt is made until successful, to read a word in the configuration range ("protection word" or "control word") from the address <ConfAddr>. Only changing data is transferred via the interface.

Command: "bg" <DeviceNo> <ConfAddr> <CHCK>
<ETX>
Response: <Status> <DeviceNo> <CHCK> <ETX>

Enhanced Buffered Get Configuration:

This command behaves like the buffered get configuration command; the status "5" is only output when a data carrier leaves the read range.

Command: "sg" <DeviceNo> <ConfAddr> <CHCK>
<ETX>
Response: <Status> <DeviceNo> <CHCK> <ETX>

6.2.5 IPC03 password mode



Note!

The password is a 32-bit word that is set to "0" before a new IPC03 data carrier leaves the factory. The password cannot be read. Writing the passwords for the "control word" and the "protection word" must always be done in password mode.

Password mode

This command activates (mode = "1") and deactivates (mode = "0") the password mode of the read station. In the password mode, the password is transferred to the data carrier before each read/write access. If a data carrier is addressed with the wrong password, then even the data range, for which no password protection is set, cannot be accessed.

Command: "pm" <DeviceNo> <Mode> <CHCK> <ETX>
Response: <Status> <DeviceNo> <CHCK> <ETX>

Password Set

This command sets the password, which the read station communicates to the data carrier in the password mode.

Command: "ps" <DeviceNo> <Password> <CHCK> <ETX>
Response: <Status> <DeviceNo> <CHCK> <ETX>

Password Change

This command changes the password in a data carrier. Here, first the old and then the new password has to be entered. If the password has been successfully written, then the password in the read station is also changed. The command password set is no longer necessary. The password of the IPC03 can also be changed with password mode inactive.

Command: "pc" <DeviceNo> <Password old> <Password new> <CHCK> <ETX>
Response: <Status> <DeviceNo> <CHCK> <ETX>

6.2.6 Write fixcode

Commands for the IPC10

The data carrier IPC10 is formatted during the first write process. It can therefore only be read when it has already been written.

The word start address is set to '0' for the read and write commands. The word count can be 1 or 3. For read commands, the word count is set to '0' since exactly the same amount of words are read as were previously written.

An IPC10 can also be programmed such that it behaves like an IPC02. To do this, the commands **SX**, **AX**, **BX** and **EX** are used. This programming takes place once, i.e. it can not be reversed (once the code is written it cannot be overwritten). The code is read when data carrier type 02 or 10 is set with the commands **SF**, **AF**, **BF** and **EF**.

Here, <FixType> is always "02" and <FixLen> is always "05", since 5 bytes must always be written.

Single write fixcode:

One attempt is made to write a fixcode.

Command:	"sx" <DeviceNo> <FixType> <FixLen> <Data> <CHCK> <ETX>
Response:	<Status> <DeviceNo> <CHCK> <ETX>

Auto write fixcode

An attempt is made to write a fixcode until successful.

Command:	"ax" <DeviceNo> <FixType> <FixLen> <Data> <CHCK> <ETX>
Response:	<Status> <DeviceNo> <CHCK> <ETX>

Buffered write fixcode

One attempt is made to write a fixcode. After each successful write, the response is sent and the system waits until a new data carrier is within the detection range. The command then starts again from the beginning.

Command:	"bx" <DeviceNo> <FixType> <FixLen> <Data> <CHCK> <ETX>
Response:	<Status> <DeviceNo> <CHCK> <ETX>

Enhanced Buffered Write Fixcode

This command behaves like the buffered write fixcode command; the status "5" is only output when a data carrier leaves the read range.

Command:	"ex" <DeviceNo> <FixType> <FixLen> <Data> <CHCK> <ETX>
Response:	<Status> <DeviceNo> <CHCK> <ETX>

6.2.7 Legend

<CHCK>:	1 ASCII character, 8-bit checksum with the addition of all preceding characters, without overrun.
<ConfAddr>:	Word start address in the configuration range of the data carrier. 1 ASCII character range from "0" to "F", depending on data carrier type. The following applies for IPC03: "1" Protection Word "2" Control Word
<Data>:	<WordNum> times 4 bytes
<Date>:	Application software version date
<DeviceNo>:	Read head number 2 ASCII characters, range from "01" to "1E".
<ETX>:	1 ASCII character 03
<FixLen>:	2 ASCII characters "05" for IPC02
<FixType>:	2 ASCII characters "02" for IPC02
<Mode>:	1 ASCII character "0" or "1"
<Status>:	1 ASCII character
<SW-No>:	Application software number
<Tagtype>:	2 ASCII characters
<Timeout>:	Interface timeout; an error message is sent after this time runs out.
<WordAddr>:	Word start address in the data carrier, 4 ASCII characters, range from '0000h' to 'FFFFh', depending on data carrier type.
<WordNum>:	Number of words to be read or written, 2 ASCII characters. Range from "00" to "FF", depending on data carrier type. The following applies for the IPC03 The word count 00h is used with the word address "0000" to read the preset data range on the data carrier.

6.2.8 Status and error messages

Status	Fault
0	No fault
2	Switch-on message; device is ready for operation
4	Incorrect or incomplete command or parameter not in the valid range
5	Read error or write error

7 Technical specifications

7.1 Read/write station IPT*-FP

IPT*-FP

General data

Operating frequency	125 kHz
Transfer rate	2 kBit/s
Operating distance	max. 100 mm

Display/controls

LED green	Power on
LED yellow	IPC recognized
LED red	Bus error (with the use of field bus interfaces)

Electrical data

Rated operating voltage U_e	20 ... 30 V DC, ripple 10 % _{SS} , PELV
Power consumption P_0	max. 5 W, in connection with lower section
Galvanic isolation	
Operating voltage/Interface	Functional isolation in accordance with DIN EN 50178, rated isolation voltage 50 V _{eff}

Interface

Physical	Interface type depends on the lower section used
----------	--------------------------------------------------

Ambient conditions

Ambient temperature	-25 ... 70 °C (248 ... 343 K)
Storage temperature	-40 ... 85 °C (233 ... 358 K)

Mechanical data

Degree of protection	IP67 in accordance with IN 60529, in connection with lower section
Housing material	PBT (Polybutylene terephthalate)

Dimensions of the read/write station

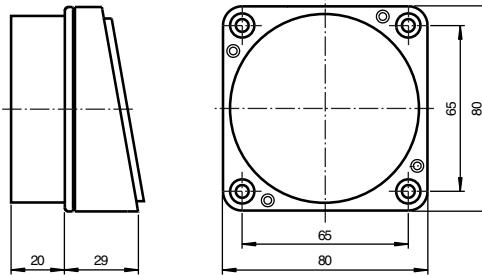

7.2 Read/write distances IPT*-FP

Distances	Data carrier type	in air
Read distance with	IPC02-20W	0 mm...40 mm
Read distance with	IPC02-30W	0 mm...50 mm
Read distance with	IPC02-50W	0 mm...80 mm
Read distance with	IPC02-C1	0 mm...80 mm
Read distance with	IPC02-68-T5	0 mm...50 mm
Read distance with	IPC03-20W	0 mm...30 mm
Write distance with	IPC03-20W	0 mm...25 mm
Read distance with	IPC03-30W	0 mm...40 mm
Write distance with	IPC03-30W	0 mm...30 mm
Read distance with	IPC03-50W	0 mm...60 mm
Write distance with	IPC03-50W	0 mm...45 mm
Read distance with	IPC03-C1	0 mm...60 mm
Write distance with	IPC03-C1	0 mm...45 mm
Read distance with	IPC10-20	0 mm...30 mm
Write distance with	IPC10-20	0 mm...25 mm

206843_2009-03

7.3 U-P6-R4 lower section

U-P6-R4	
Electrical data	
Rated operating voltage U_e	20 ... 30 V DC, ripple 10 % _{SS} , PELV
Serial interface	
Type	RS 485, addressable
Transfer rate in baud	1200, 2400, 4800, 9600, 19200, 38400
Permitted total cable length	1200 m
Ambient conditions	
Ambient temperature	-25 ... 70 °C (248 ... 343 K)
Storage temperature	-40 ... 85 °C (233 ... 358 K)
Mechanical data	
Degree of protection	IP67 according to EN 60529 with IPT*-FP
Connection	Screw terminals
Interface cable	2-wire accordant with RS 485
Power supply	up to 3 x 1.5mm ²
Housing material	Aluminum, black anodized

U-P6-R4 lower section

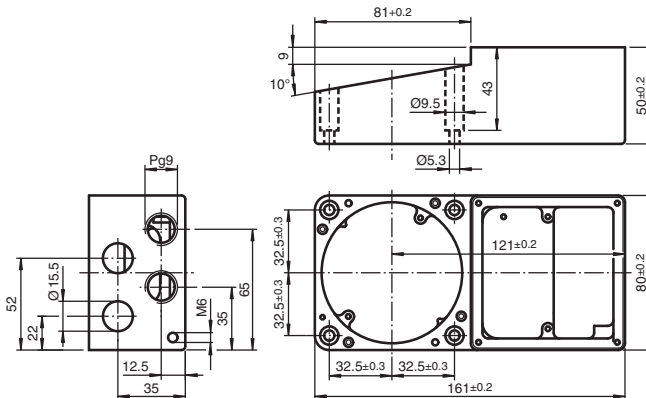

205843 2009-03

U-P6-R4 electrical connection

incoming interface

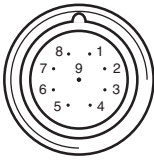

connector

- 1 DO1
- 2 /DO1
- 3 DI1
- 4 /DI1
- 5 GND
- 6 PE
- 7 +24 V
- 8 0 V
- 9

outgoing interface

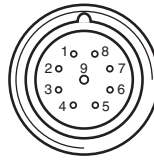

socket

- 1 DO2
- 2 /DO2
- 3 DI2
- 4 /DI2
- 5 GND
- 6 PE
- 7 +24 V
- 8 0 V
- 9 /RBST

FACTORY AUTOMATION – SENSING YOUR NEEDS



Worldwide Headquarters

Pepperl+Fuchs GmbH
68307 Mannheim · Germany
Tel. +49 621 776-0
E-mail: info@de.pepperl-fuchs.com

USA Headquarters

Pepperl+Fuchs Inc.
Twinsburg, Ohio 44087 · USA
Tel. +1 330 4253555
E-mail: sales@us.pepperl-fuchs.com

Asia Pacific Headquarters

Pepperl+Fuchs Pte Ltd.
Company Registration No. 199003130E
Singapore 139942
Tel. +65 67799091
E-mail: sales@sg.pepperl-fuchs.com

www.pepperl-fuchs.com

 **PEPPERL+FUCHS**
SENSING YOUR NEEDS