



Zener Barrier

Z822

- 1-channel
- DC version, negative polarity
- Working voltage 19 V at 10 μ A
- Series resistance max. 166 Ω
- Fuse rating 50 mA
- DIN rail mountable



Function

The Zener Barrier prevents the transfer of unacceptably high energy from the safe area into the hazardous area. The zener diodes in the Zener Barrier are connected in the reverse direction. The breakdown voltage of the diodes is not exceeded in normal operation. If this voltage is exceeded, due to a fault in the safe area, the diodes start to conduct, causing the fuse to blow. The Zener Barrier has a negative polarity, i. e. the cathodes of the zener diodes are grounded.

Connection

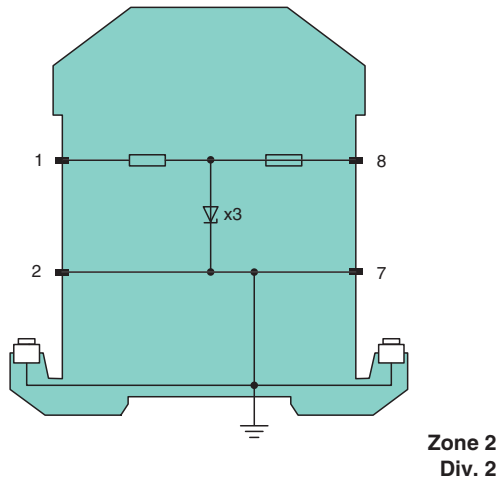
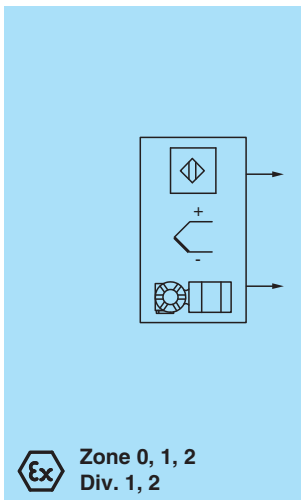

Technical Data

General specifications	
Type	DC version, negative polarity
Electrical specifications	
Nominal resistance	150 Ω
Series resistance	max. 166 Ω
Fuse rating	50 mA
Hazardous area connection	
Connection	terminals 1, 2
Safe area connection	
Connection	terminals 7, 8
Working voltage	
Supply loop	max. 19.6 V

Release date: 2023-04-06 Date of issue: 2023-04-06 Filename: 071785_eng.pdf

Refer to "General Notes Relating to Pepperl+Fuchs Product Information".

Pepperl+Fuchs Group
www.pepperl-fuchs.com

USA: +1 330 486 0002
pa-info@us.pepperl-fuchs.com

Germany: +49 621 776 2222
pa-info@de.pepperl-fuchs.com

Singapore: +65 6779 9091
pa-info@sg.pepperl-fuchs.com

PEPPERL+FUCHS

Technical Data







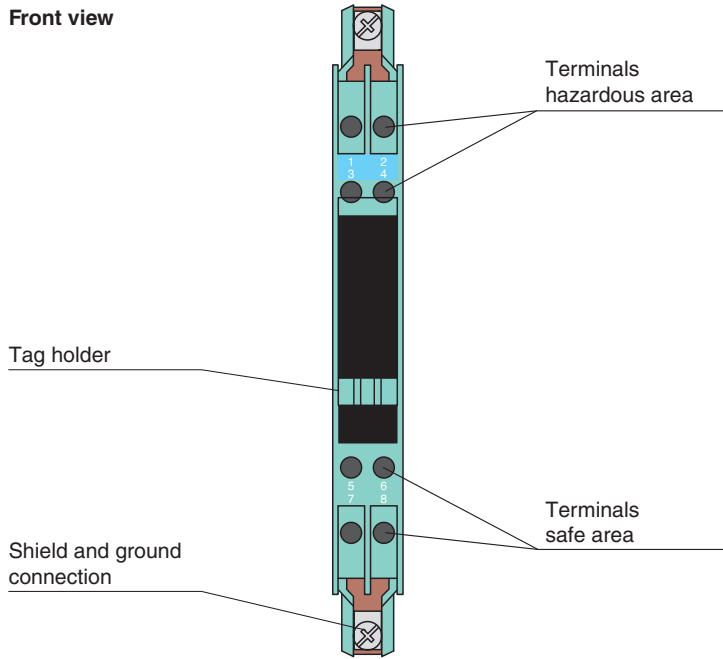



Measurement loop		max. 19 V at 10 μ A
Conformity		
Degree of protection		IEC 60529
Ambient conditions		
Ambient temperature		-20 ... 60 °C (-4 ... 140 °F)
Storage temperature		-25 ... 70 °C (-13 ... 158 °F)
Relative humidity		max. 75 % , without condensation
Mechanical specifications		
Degree of protection		IP20
Connection		screw terminals
Core cross section		max. 2 x 2.5 ... mm ²
Mass		approx. 150 g
Dimensions		12.5 x 115 x 116 mm (0.5 x 4.5 x 4.6 inch) (W x H x D)
Construction type		modular terminal housing , see system description
Mounting		on 35 mm DIN mounting rail acc. to EN 60715:2001
Data for application in connection with hazardous areas		
EU-type examination certificate		BAS 01 ATEX 7005
Marking		Ⓢ II (1)GD, I (M1) [Ex ia Ga] IIC, [Ex ia Da] IIIC, [Ex ia Ma] I
Voltage	U _o	22 V
Current	I _o	150 mA
Power	P _o	820 mW
Supply		
Maximum safe voltage	U _m	250 V
Series resistance		min. 147 Ω
Certificate		TÜV 99 ATEX 1484 X
Marking		Ⓢ II 3G Ex nA IIC T4 Gc
Directive conformity		
Directive 2014/34/EU		EN IEC 60079-0:2018+AC:2020 , EN 60079-11:2012 , EN 60079-15:2010
International approvals		
FM approval		
Control drawing		116-0118
UL approval		
Control drawing		116-0139 (cULus)
IECEx approval		
IECEx certificate		IECEx BAS 09.0142 IECEx BAS 17.0091X
IECEx marking		[Ex ia Ga] IIC , [Ex ia Da] IIIC , [Ex ia Ma] I Ex ec IIC T4 Gc
General information		
Supplementary information		Observe the certificates, declarations of conformity, instruction manuals, and manuals where applicable. For information see www.pepperl-fuchs.com .

Assembly

Front view



Matching System Components

	ZH-ES/LB	Insertion Strip
	ZH-Z.AB/NS	Mounting block for DIN mounting rail
	ZH-Z.AB/SS	Mounting block for grounding rail
	ZH-Z.AK16	Connection terminal for grounding rail
	ZH-Z.AR.125	Spacing Roller
	ZH-Z.BT	Label Carrier
	ZH-Z.ES	Single Socket
	ZH-Z.LL	Ground Rail Feed
	ZH-Z.NLS-Cu3/10	Grounding Rail
	USLKG5	Terminal block for equipotential bonding

Release date: 2023-04-06 Date of issue: 2023-04-06 Filename: 071785_eng.pdf

Refer to "General Notes Relating to Pepperl+Fuchs Product Information".