

# Connection cable

## V1-G-1M-PUR-V1-W

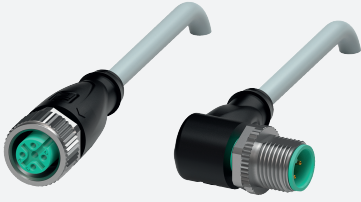

- Degree of protection IP68 / IP69
- Resistant to microbes and hydrolysis
- Halogen-free
- Specific design protects against loosening and inaccurate installation

Cordset M12 socket straight to M12 plug angled A-coded, 4-pin, PUR cable grey



### Dimensions

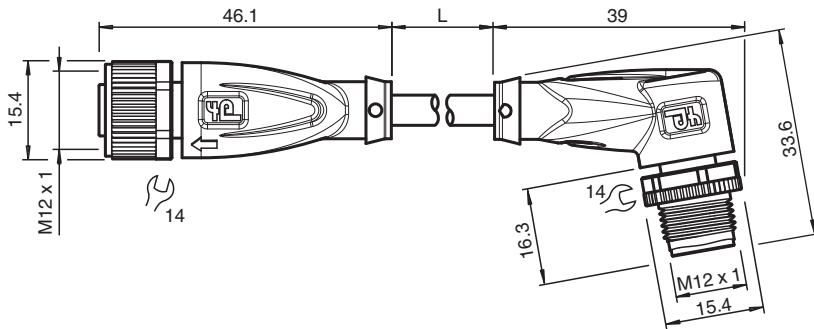

### Technical Data

General specifications			
Connector 1			
Connection			socket
Construction type			M12
Style			straight
Locking			screw connection
Number of pins			4
Coding			A-coded
Connector 2			
Connection			plug
Construction type			M12
Style			angled
Locking			screw connection
Number of pins			4
Coding			A-coded
Electrical specifications			
Operating voltage	U <sub>B</sub>		max. 250 V AC/DC
Operating current	I <sub>B</sub>		max. 4 A
Conformity			
Degree of protection			EN 60529
Plug connection			connector M12 x 1 : IEC 61076-2-101

Release date: 2023-07-13 Date of issue: 2023-07-13 Filename: 096745\_eng.pdf

Refer to "General Notes Relating to Pepperl+Fuchs Product Information".

Pepperl+Fuchs Group  
www.pepperl-fuchs.com

USA: +1 330 486 0001  
fa-info@us.pepperl-fuchs.com

Germany: +49 621 776 1111  
fa-info@de.pepperl-fuchs.com

Singapore: +65 6779 9091  
fa-info@sg.pepperl-fuchs.com

PEPPERL+FUCHS

## Technical Data





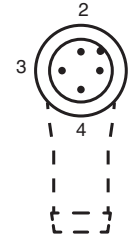
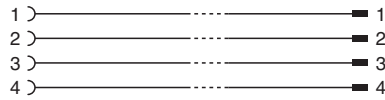
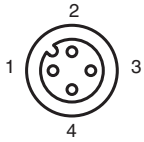

Halogen-free	IEC 60754-1	
<b>Ambient conditions</b>		
Ambient temperature		
Plug connector		-40 ... 90 °C (-40 ... 194 °F)
Cable, fixed		-40 ... 80 °C (-40 ... 176 °F)
Cable, flexing		-25 ... 80 °C (-13 ... 176 °F)
Pollution degree	3	
<b>Mechanical specifications</b>		
Plug connector		
Tightening torque		0.6 Nm
Loosening protection	available	
Tool installation		straight knurling and hexagon nut SW = 14 mm
Mating cycles	min. 100	
Degree of protection	IP68 / IP69	
Cable		
according to IEC/EN 60228 (DIN VDE 0295) class 5		
Sheath diameter		4.8 mm
Bending radius		> 10 x cable diameter, moving > 8 x cable diameter, fixed
Sheath stripping force		max. 60 N / 500 mm
Sheath color	grey (similar to RAL 7001)	
Number of cores		4
Core cross section	0.34 mm <sup>2</sup>	
Cores color		Core 1: brown Core 2: white Core 3: blue Core 4: black
Core construction	19 x 0.15 mm Ø	
Length	L	1 m
Cable code	Li 9Y 11YM 4 x 0.34	
Drag chain suitability		
Drag chain cycles	max. 50 / day	
Motion velocity	max. 0.3 m/s	
<b>Material</b>		
Halogen-free	yes	
Plug connector		
Screw connection	Zinc diecast, nickel-plated	
Body	TPU, black	
Seal	FKM	
Contact surface	gold plated (Au)	
Flammability	V-2	
Cable		
Sheathing	PUR based on polyether	
Core insulation	PP	
Chemical resistance	good	
Microbial resistance	yes	
Hydrolysis resistance	yes	

Release date: 2023-07-13 Date of issue: 2023-07-13 Filename: 096745\_eng.pdf

## Connection



## Accessories

	<b>MH V1-SCREWDRIVER</b>	Torque screwdriver (0.6 Nm)
	<b>MH V1-BIT M12</b>	plug-in cap M12
	<b>V1/V3-LABELHOLDER</b>	Label holder
	<b>V1/V3-LABEL</b>	Label plate
	<b>MH V1-Holder</b>	Modular universal holder for M12 connectors
	<b>V1-CLIP</b>	Unlocking protector for M12 connector
	<b>V1-MARKING-RING-COLOR</b>	Marking rings for M12 connectors, various colors