

Switch Amplifier

KFA4-SR2-Ex1.W

- 1-channel
- Control circuit EEx ia IIC
- Reversible mode of operation
- 1 relay contact output (change-over contact)
- EMC acc. to NAMUR NE 21
- LB/SC monitoring
- Up to SIL 2 acc. to IEC/EN 61508 / IEC/EN 61511



Function

This isolated barrier is used for intrinsic safety applications. It transfers digital signals (NAMUR sensors/mechanical contacts) from a hazardous area to a safe area. The proximity sensor or switch controls a form C changeover relay contact for the safe area load. The barrier output changes state when the input signal changes state. The normal output state can be reversed using switch S1. Switch S3 is used to enable or disable line fault detection of the field circuit. During an error condition, relays revert to their de-energized state and LEDs indicate the fault according to NAMUR NE44.

Connection

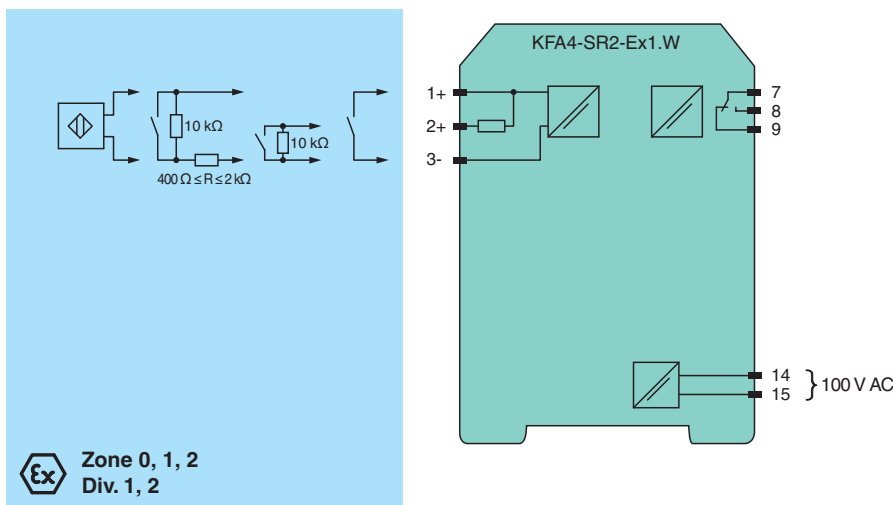

Technical Data

General specifications	
Signal type	Digital Input
Functional safety related parameters	
Safety Integrity Level (SIL)	SIL 2
Supply	
Connection	terminals 14, 15
Rated voltage	U _r 90 ... 110 V AC , 45 ... 65 Hz
Power consumption	1 W
Input	
Connection side	field side
Connection	terminals 1+, 2+, 3-

Release date: 2023-03-20 Date of issue: 2023-03-20 Filename: 112746_eng.pdf

Refer to "General Notes Relating to Pepperl+Fuchs Product Information".

Pepperl+Fuchs Group
www.pepperl-fuchs.com

USA: +1 330 486 0002
pa-info@us.pepperl-fuchs.com

Germany: +49 621 776 2222
pa-info@de.pepperl-fuchs.com

Singapore: +65 6779 9091
pa-info@sg.pepperl-fuchs.com

PEPPERL+FUCHS

Technical Data

Rated values	acc. to EN 60947-5-6 (NAMUR)	
Open circuit voltage/short-circuit current	approx. 8 V DC / approx. 8 mA	
Switching point/switching hysteresis	1.2 ... 2.1 mA / approx. 0.2 mA	
Line fault detection	breakage $I \leq 0.1$ mA , short-circuit $I > 6$ mA	
Pulse/Pause ratio	min. 20 ms / min. 20 ms	
Output		
Connection side	control side	
Connection	terminals 7, 8, 9	
Output	signal ; relay	
Contact loading	253 V AC/2 A/cos $\phi > 0.7$; 126.5 V AC/4 A/cos $\phi > 0.7$; 40 V DC/2 A resistive load	
Energized/De-energized delay	approx. 20 ms / approx. 20 ms	
Mechanical life	10^7 switching cycles	
Transfer characteristics		
Switching frequency	< 10 Hz	
Galvanic isolation		
Input/Output	reinforced insulation according to IEC/EN 61010-1, rated insulation voltage 300 V _{eff}	
Input/power supply	reinforced insulation according to IEC/EN 61010-1, rated insulation voltage 300 V _{eff}	
Output/power supply	reinforced insulation according to IEC/EN 61010-1, rated insulation voltage 300 V _{eff}	
Indicators/settings		
Display elements	LEDs	
Control elements	DIP switch	
Configuration	via DIP switches	
Labeling	space for labeling at the front	
Directive conformity		
Electromagnetic compatibility		
Directive 2014/30/EU	EN 61326-1:2013 (industrial locations)	
Low voltage		
Directive 2014/35/EU	EN 61010-1:2010	
Conformity		
Electromagnetic compatibility	NE 21:2006	
Degree of protection	IEC 60529:2001	
Input	EN 60947-5-6:2000	
Ambient conditions		
Ambient temperature	-20 ... 60 °C (-4 ... 140 °F)	
Mechanical specifications		
Degree of protection	IP20	
Connection	screw terminals	
Mass	approx. 150 g	
Dimensions	20 x 119 x 115 mm (0.8 x 4.7 x 4.5 inch) (W x H x D) , housing type B2	
Mounting	on 35 mm DIN mounting rail acc. to EN 60715:2001	
Data for application in connection with hazardous areas		
EU-type examination certificate	PTB 00 ATEX 2081	
Marking	Ⓢ II (1)G [Ex ia Ga] IIC Ⓢ II (1)D [Ex ia Da] IIIC Ⓢ I (M1) [Ex ia Ma] I	
Input	Ex ia	
Voltage	U _o	10.6 V
Current	I _o	19.1 mA
Power	P _o	51 mW (linear characteristic)
Supply		
Maximum safe voltage	U _m	110 V AC (Attention! U _m is no rated voltage.)
Output		
Contact loading	253 V AC/2 A/cos $\phi > 0.7$; 126.5 V AC/4 A/cos $\phi > 0.7$; 40 V DC/2 A resistive load	
Maximum safe voltage	U _m	253 V AC (Attention! The rated voltage can be lower.)

Release date: 2023-03-20 Date of issue: 2023-03-20 Filename: 112746_eng.pdf

Refer to "General Notes Relating to Pepperl+Fuchs Product Information".

Technical Data

Galvanic isolation	
Input/Output	safe electrical isolation acc. to IEC/EN 60079-11, voltage peak value 375 V
Input/power supply	safe electrical isolation acc. to IEC/EN 60079-11, voltage peak value 375 V
Directive conformity	
Directive 2014/34/EU	EN IEC 60079-0:2018+AC:2020 , EN 60079-11:2012
International approvals	
IECEX approval	
IECEX certificate	IECEX PTB 11.0031
IECEX marking	[Ex ia Ga] IIC [Ex ia Da] IIIC [Ex ia Ma] I
General information	
Supplementary information	Observe the certificates, declarations of conformity, instruction manuals, and manuals where applicable. For information see www.pepperl-fuchs.com .

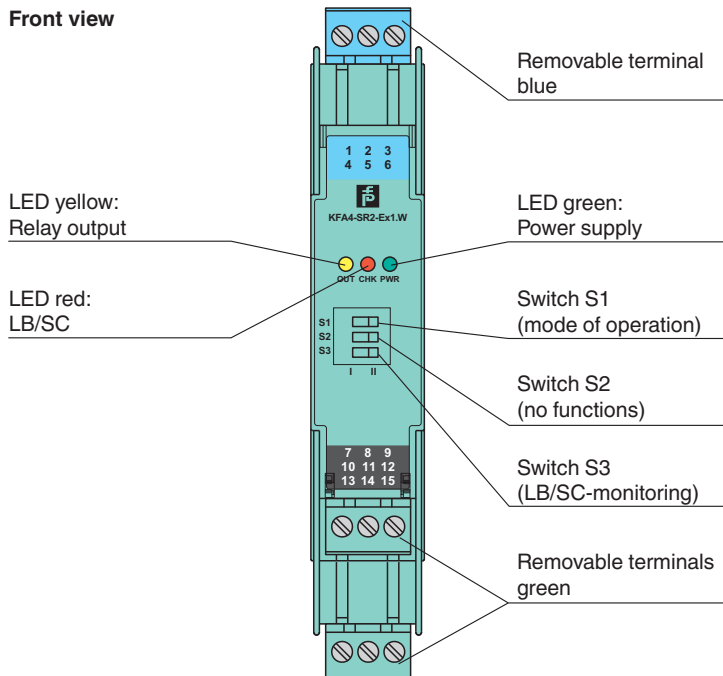

Assembly



Matching System Components

	K-DUCT-BU	Profile rail, wiring comb field side, blue
---	------------------	--

Accessories

	F-NR3-Ex1	NAMUR Resistor Network
	KF-ST-5GN	Terminal block for KF modules, 3-pin screw terminal, green
	KF-ST-5BU	Terminal block for KF modules, 3-pin screw terminal, blue

Release date: 2023-03-20 Date of issue: 2023-03-20 Filename: 112746_eng.pdf

Refer to "General Notes Relating to Pepperl+Fuchs Product Information".

Accessories



KF-CP

Red coding pins, packaging unit: 20 x 6

Release date: 2023-03-20 Date of issue: 2023-03-20 Filename: 112746_eng.pdf

Refer to "General Notes Relating to Pepperl+Fuchs Product Information".

Pepperl+Fuchs Group
www.pepperl-fuchs.com

USA: +1 330 486 0002
pa-info@us.pepperl-fuchs.com

Germany: +49 621 776 2222
pa-info@de.pepperl-fuchs.com

Singapore: +65 6779 9091
pa-info@sg.pepperl-fuchs.com

Characteristic Curve

Maximum switching power of output contacts

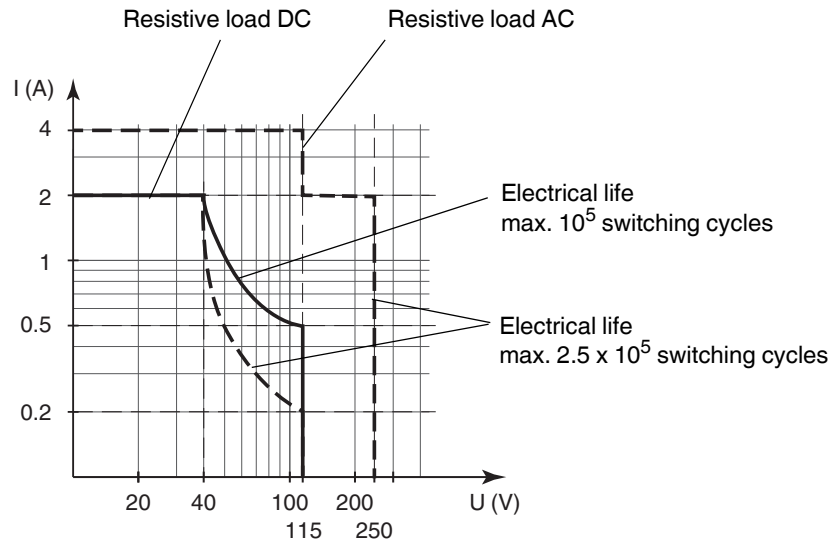

The maximum number of switching cycles is depending on the electrical load and may be higher when reduced currents and voltages are applied.

Release date: 2023-03-20 Date of issue: 2023-03-20 Filename: 112746_eng.pdf

Refer to "General Notes Relating to Pepperl+Fuchs Product Information".