

Active infrared scanner

AIR30-8-H-2542/38a

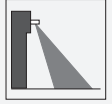

- Single-beam light scanner
- Can be used to monitor both main and ancillary closing edges
- Closing edge safety on revolving doors and carousel doors
- Accurate beam alignment thanks to finely bundled light beam
- Background suppression operating mode: ignores objects outside the sensing range
- Version for universal voltages

Single-beam active infrared scanner, background suppression, max. installation height 2.5 m, black housing, relay contact output, fixed cable



Function

AIR30 is a series of active infrared scanners with excellent optical properties for monitoring closing edges in a wide range of door systems. The diverse range of housings and mounting options allow the devices to be adapted to suit a whole host of mounting conditions.

Application

- Monitoring closing edges and crushing points on revolving doors and carousel doors
- Door monitoring system in local public transportation

Dimensions

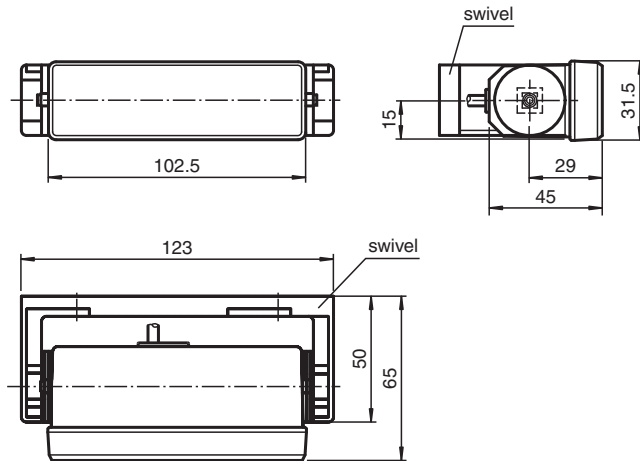

Mounting dimensions for swivel

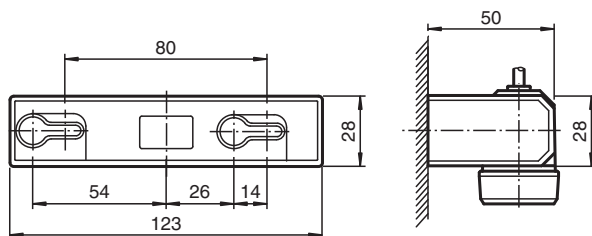

Mounting dimensions with mounting bracket set AIR30

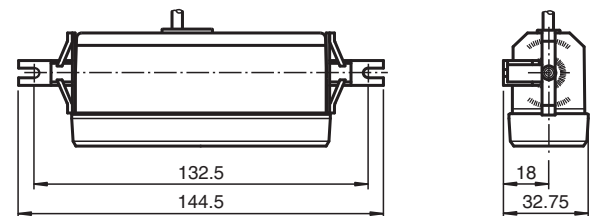

Technical Data

General specifications

Detection range min.	550 ... 1000 mm
Detection range max.	550 ... 2500 mm
Light source	IRED
Light type	modulated infrared light
Black-white difference (6%/90%)	≤ 400 mm at a distance of 2000 mm
Transmitter frequency	1800 Hz
Operating mode	Background suppression
Diameter of the light spot	50 mm at 2000 mm sensor range
Opening angle	approx. 1.4 °
Accessories provided	Swivel bracket, Mounting bracket

Functional safety related parameters

MTTF _d	1050 a
Mission Time (T _M)	20 a
Diagnostic Coverage (DC)	90 %

Indicators/operating means

Function indicator	LED red: lights up when output is active
Control elements	Sensing range adjuster, light-on/dark-on changeover switch
Factory setting	light-on

Electrical specifications

Operating voltage	U _B	10 ... 48 V DC / 11 ... 36 V AC
No-load supply current	I ₀	100 mA

Release date: 2023-03-28 Date of issue: 2023-03-28 Filename: 112799_eng.pdf

Refer to "General Notes Relating to Pepperl+Fuchs Product Information".

Pepperl+Fuchs Group
www.pepperl-fuchs.comUSA: +1 330 486 0001
fa-info@us.pepperl-fuchs.comGermany: +49 621 776 1111
fa-info@de.pepperl-fuchs.comSingapore: +65 6779 9091
fa-info@sg.pepperl-fuchs.com

Technical Data

Input	
Test input	emitter deactivation at +U _B
Output	
Switching type	light/dark on, switchable
Signal output	relay, 1 NO
Switching voltage	≤ 50 V AC / 24 V DC
Switching current	≤ 200 mA AC / 1 A DC
Response time	70 ms
De-energized delay	t _{off} approx. 200 ms
Standard conformity	
Standards	EN 60947-5-2
Standards 2	EN 61000-6-2 without EN 61000-4-5, EN 61000-4-11
Standards 3	EN 61000-6-3
Ambient conditions	
Ambient temperature	-20 ... 60 °C (-4 ... 140 °F)
Storage temperature	-20 ... 75 °C (-4 ... 167 °F)
Mechanical specifications	
Degree of protection	IP52
Connection	fixed cable high flexibility 2.5 m
Material	
Housing	plastic
Optical face	Luran®
Mass	50 g

Connection Assignment

Option:

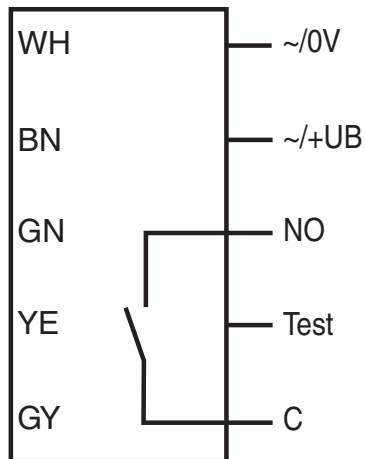

Assembly

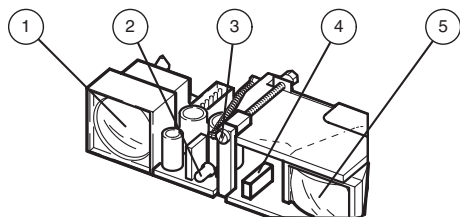

1	Transmitter
2	Indication-LED
3	Detection range adjuster
4	Light / Dark switch
5	Receiver

Characteristic Curve

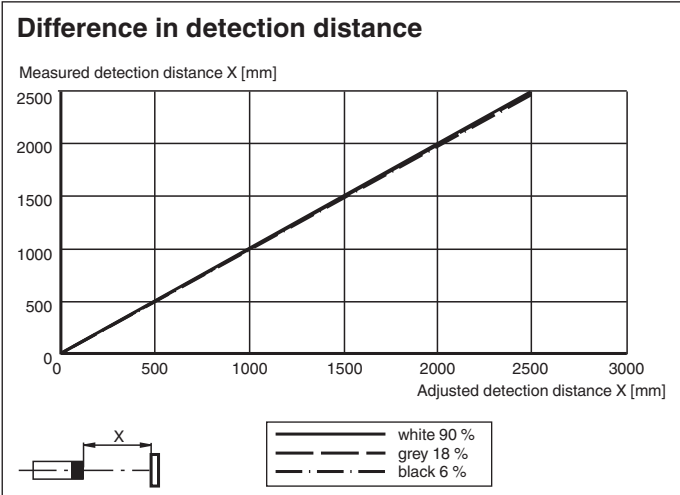
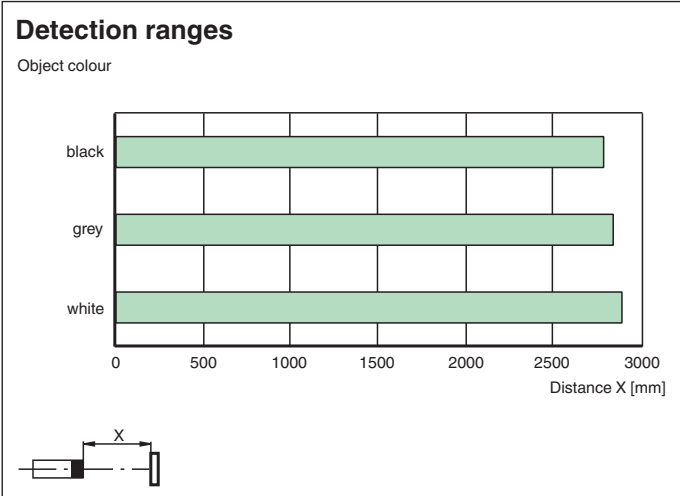
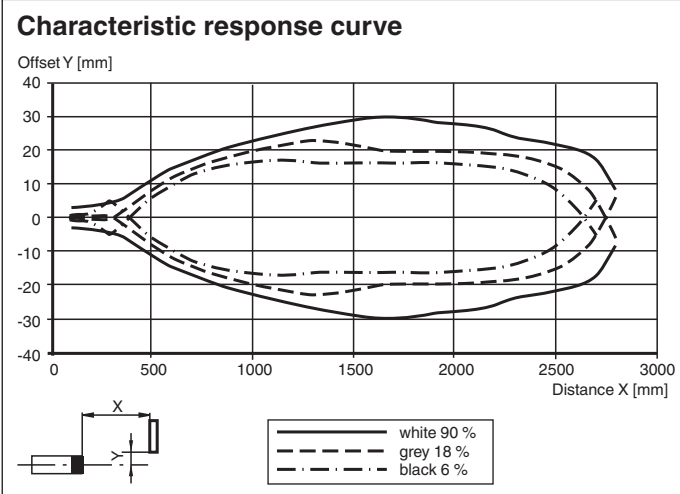

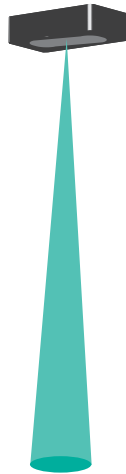

Release date: 2023-03-28 Date of issue: 2023-03-28 Filename: 112799_eng.pdf

Application



Accessories

	UP-Einbaurahmen	Mounting frame for sensors in the AIR30 and PROSCAN series
	Flush Mounting AIR30	Installation cover for AIR30 series sensors
	Wetterhaube AIR30	Weather hood for series AIR30

Function Principle

Active infrared scanners detect people and objects using short-wave infrared radiation according to the triangulation principle. A switch signal is tripped if the infrared beam emitted is reflected by an object within the specified sensing range. Where background suppression is activated, the background (e.g. ground) is detected but not evaluated. This allows an extremely precise detection area to be set and ensures reliable detection of people, vehicles and other objects.

**Function principle
background suppression**

