

Safety light grid

SLP10-2-L

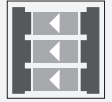

- Sensing range up to 10 m
- Self-monitoring (type 4 according to IEC/EN 61496-1)
- 2-radial design
- Beam spacing 500 mm
- Red transmission light
- Integrated function display
- Pre-fault indication
- Operation on control units of SB4 (SafeBox)



Dimensions

Option -L with indicator lamp
(receiver only)

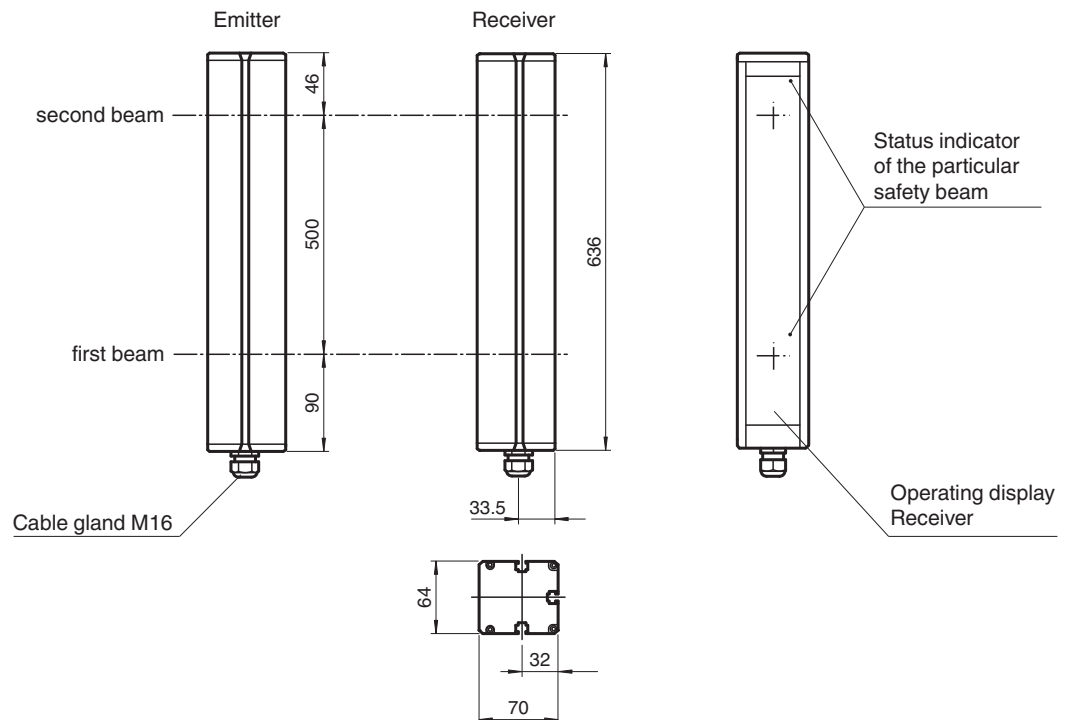
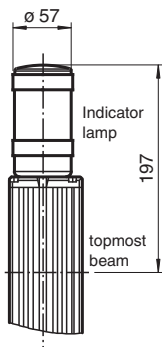

Technical Data

System components

Emitter	SLP10-2-T
Receiver	SLP10-2-R-L

General specifications

Effective detection range	0.2 ... 10 m
Light source	LED

Release date: 2020-08-27 Date of issue: 2020-10-06 Filename: 114430_eng.pdf

Refer to "General Notes Relating to Pepperl+Fuchs Product Information".

Pepperl+Fuchs Group
www.pepperl-fuchs.com

USA: +1 330 486 0001
fa-info@us.pepperl-fuchs.com

Germany: +49 621 776 1111
fa-info@de.pepperl-fuchs.com

Singapore: +65 6779 9091
fa-info@sg.pepperl-fuchs.com

PF PEPPERL+FUCHS

Technical Data

Light type		modulated visible red light
Tests		IEC/EN 61496
Safety type according to IEC/EN 61496		4
Marking		CE
Target size		static: 32 mm dynamic: 50 mm (at v = 1.6 m/s of the obstacle)
Beam spacing		500 mm
Number of beams		2
Angle of divergence		< 5 °
Functional safety related parameters		
Performance level (PL)		PL e
Category		Cat. 4
Mission Time (T _M)		20 a
PFH _d		2.81 E-9
Type		4
Indicators/operating means		
Operation indicator		LED red in receiver
Function indicator		LED red: per receiver channel off: Interruption flashes: receiver continuously on: reception with sufficient stability control
Muting indicator		Indicator lamp
Pre-fault indicator		Functional display flashing
Electrical specifications		
Operating voltage	U _B	Power supply via control unit
Protection class		III
Conformity		
Functional safety		ISO 13849-1
Product standard		EN 61496-1 ; IEC 61496-2
Approvals and certificates		
CE conformity		CE
Approvals		TÜV SÜD
Ambient conditions		
Ambient temperature		-20 ... 60 °C (-4 ... 140 °F)
Storage temperature		-20 ... 70 °C (-4 ... 158 °F)
Relative humidity		max. 95 %, not condensing
Mechanical specifications		
Degree of protection		IP65
Connection		M16 cable gland , terminal compartment
Connection options		Further electrical connection options on request: Connector DIN 43 651 Hirschmann, emitter: 6-pin+PE, receiver: 11-pin+PE
Material		
Housing		extruded aluminum profile, RAL 1021 (yellow) coated
Optical face		Plastic pane
Mass		Per 2100 g

Emitter SLP

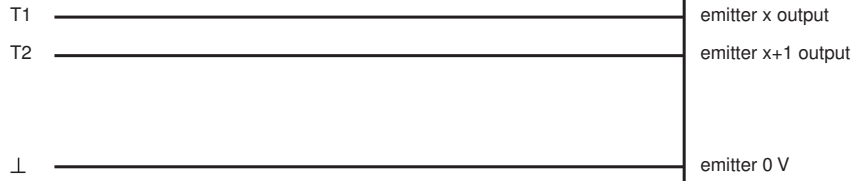
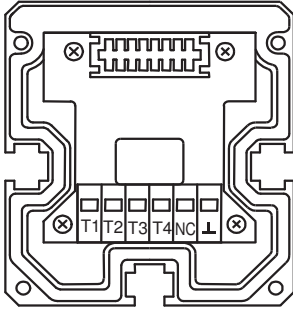

Receiver SLP (-L)

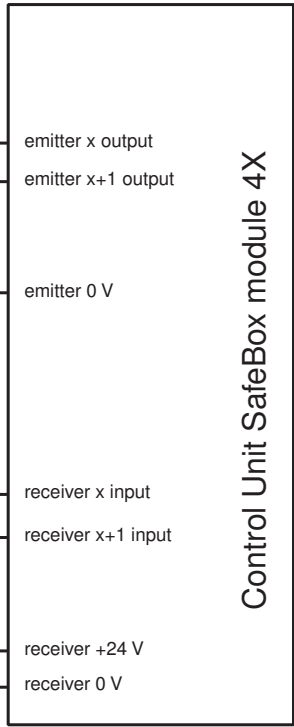
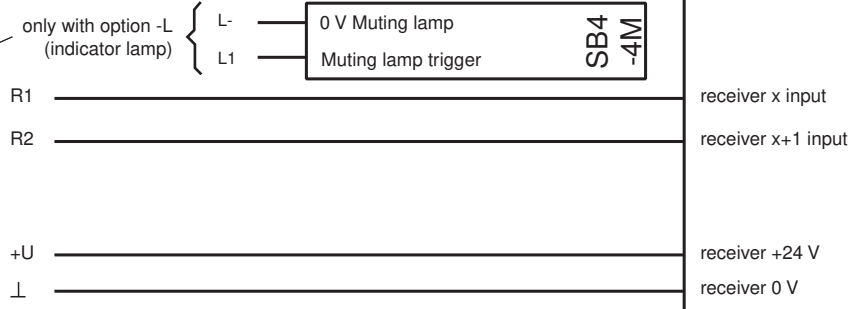
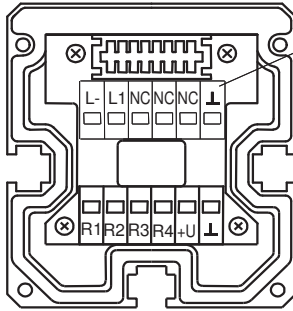

Characteristic Curve

Characteristic response curve

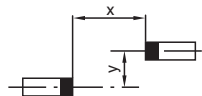
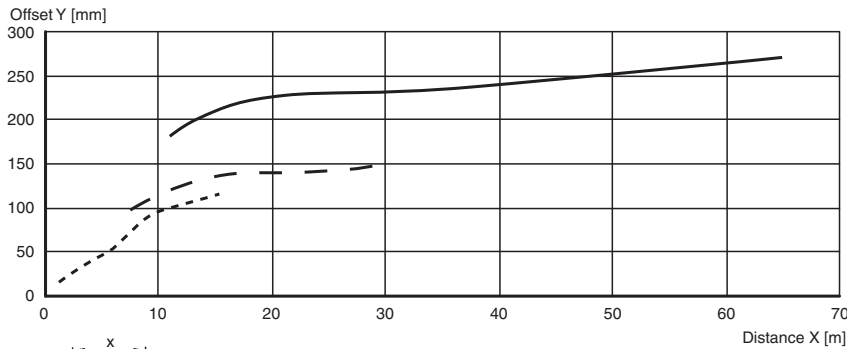

- SLP10
- - - SLP30
- SLP65

Relative received light strength

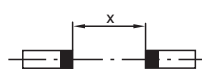
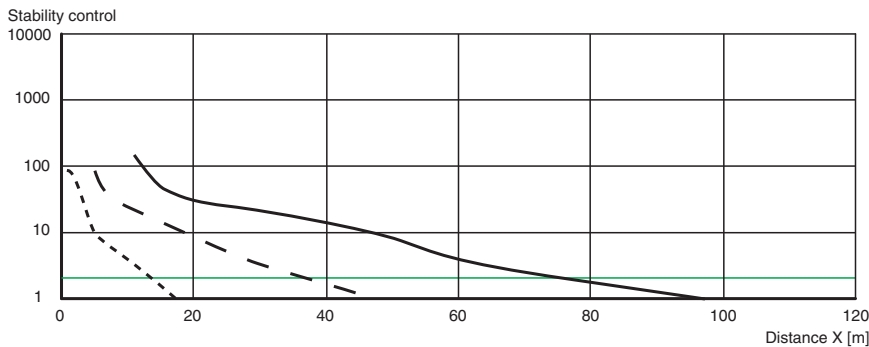

- SLP10
- - - SLP30
- SLP65

Release date: 2020-08-27 Date of issue: 2020-10-06 Filename: 114430_eng.pdf

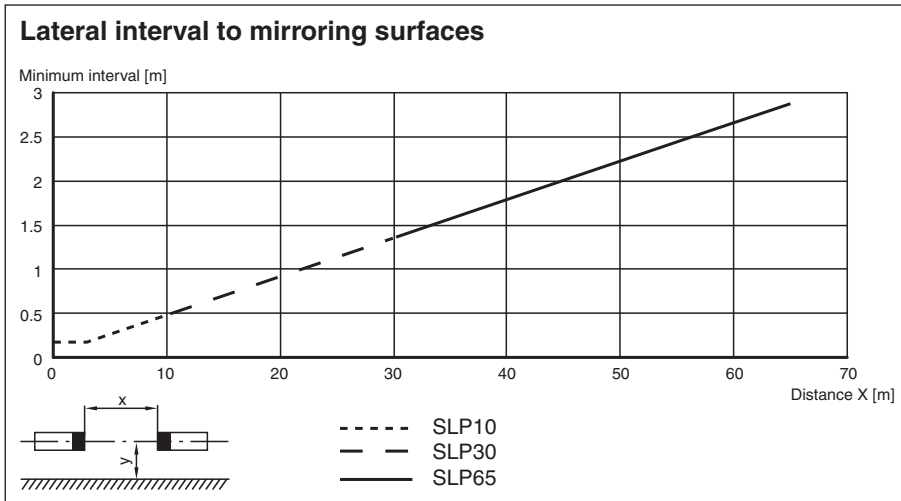

Matching system components

	SB4-OR-4XP-B-4159	Safety control unit
	SB4-OR-4XP	Safety control unit
	SB4-OR-4XP-B	SB4 series safety control unit with 1 optional module slot for functional enhancement
	SB4-OR-4XP-B-B	SB4 series safety control unit with optional module slots for functional enhancement
	SB4-OR-4XP-B-B-B	SB4 series safety control unit with optional module slots for functional enhancement
	SB4-OR-4XP-B-B-B-B	SB4 series safety control unit with optional module slots for functional enhancement
	SB4-OR-4XP-B-B-B-B-B	SB4 series safety control unit with optional module slots for functional enhancement
	SB4-OR-4XP-B-4158	Safety control unit
	SB4-OR-4XP-3819	Safety control unit
	SB4-OR-4XP-4M	Safety control unit
	SB4-OR-4XP-4MD	Safety control unit
	SB4-OR-4XP-4M-4136	Safety control unit of series SB4
	SB4-OR-4XP-4X	Safety control unit
	SB4-OR-4XP-4X-3819	Safety control unit
	SB4-OR-4XP-4136	Safety control unit of series SB4

Release date: 2020-08-27 Date of issue: 2020-10-06 Filename: 114430_eng.pdf

Refer to "General Notes Relating to Pepperl+Fuchs Product Information".

Pepperl+Fuchs Group
www.pepperl-fuchs.com













USA: +1 330 486 0001
fa-info@us.pepperl-fuchs.com

Germany: +49 621 776 1111
fa-info@de.pepperl-fuchs.com

Singapore: +65 6779 9091
fa-info@sg.pepperl-fuchs.com

PEPPERL+FUCHS

Accessories

	SLP-X-M	Deviation mirror for SLP
	MS SLP	Mounting bracket for Light grid
	PG SLP-X	Protective glass panes for SLP series
	PG HOLDER SLP	Holders for SLP protective glass panes
	PA SLP/SLC	Alignment aid for SLP and SLC series profile light grids
	UC SLP/SLC	Floor stand for all series SLP/SLC devices
	UC SLP/SLC 1530 mm	Floor stand for all series SLP/SLC devices
	Damping UC SLP/SLC	Shock absorber as ramming protector for all series SLP/SLC devices
	Enclosure UC SLP/SLC	Housing for floor stand
	MS SLP/SLA28	Fixing plate
	BINDER SLPC/M	Cable tie for the secure laying and fixing of the connection leads, in particular for the muting sensors connected to safety light grids.
	PG SLP-2	Protective glass panes for SLP series

Release date: 2020-08-27 Date of issue: 2020-10-06 Filename: 114430_eng.pdf

Refer to "General Notes Relating to Pepperl+Fuchs Product Information".

Pepperl+Fuchs Group
www.pepperl-fuchs.com

USA: +1 330 486 0001
fa-info@us.pepperl-fuchs.com

Germany: +49 621 776 1111
fa-info@de.pepperl-fuchs.com

Singapore: +65 6779 9091
fa-info@sg.pepperl-fuchs.com

Accessories

Additional accessories can be found in the Internet.

Release date: 2020-08-27 Date of issue: 2020-10-06 Filename: 114430_eng.pdf

Refer to "General Notes Relating to Pepperl+Fuchs Product Information".

Pepperl+Fuchs Group
www.pepperl-fuchs.com

USA: +1 330 486 0001
fa-info@us.pepperl-fuchs.com

Germany: +49 621 776 1111
fa-info@de.pepperl-fuchs.com

Singapore: +65 6779 9091
fa-info@sg.pepperl-fuchs.com

 **PEPPERL+FUCHS**