

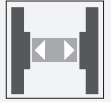

# Optical data coupler DAD15-8P-NPN



- 8 bit parallel data transfer
- Very large angle of divergence
- Can be connected in series
- Connection with spring-loaded terminals
- Degree of protection IP67

Optical data coupler



## Dimensions

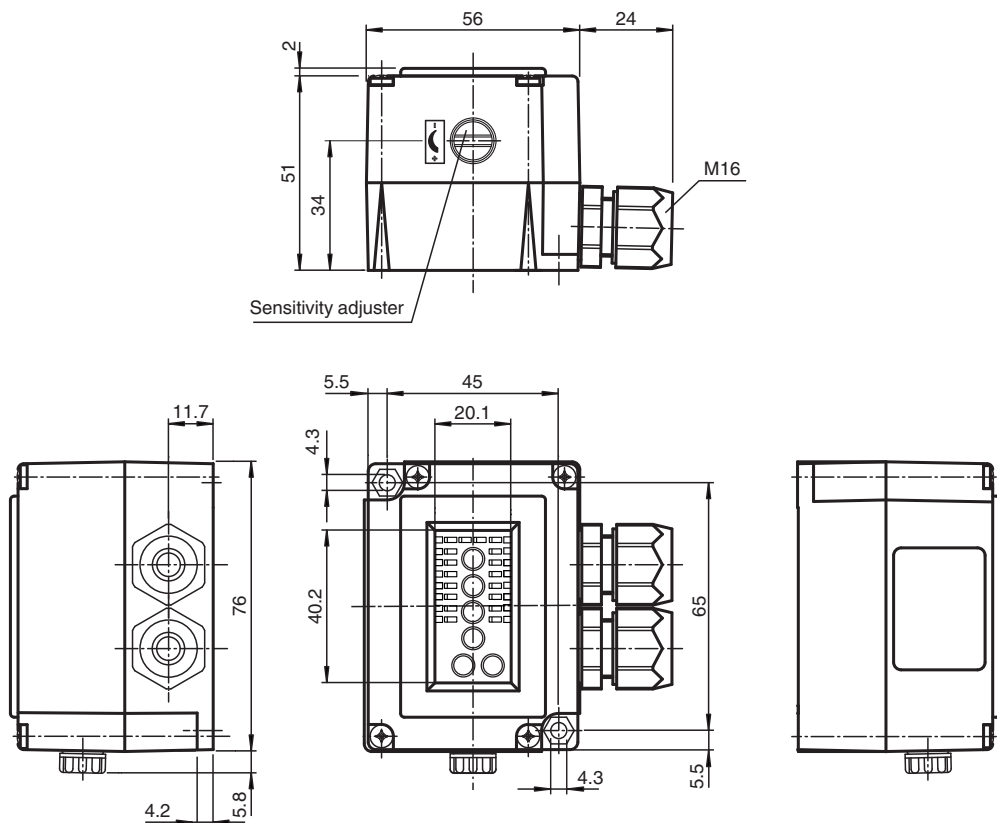

## Technical Data

### General specifications

Effective detection range	0 ... 1500 mm
Threshold detection range	2500 mm

Release date: 2021-11-25 Date of issue: 2021-11-25 Filename: 120841\_eng.pdf

Refer to "General Notes Relating to Pepperl+Fuchs Product Information".

Pepperl+Fuchs Group  
www.pepperl-fuchs.com

USA: +1 330 486 0001  
fa-info@us.pepperl-fuchs.com

Germany: +49 621 776 1111  
fa-info@de.pepperl-fuchs.com

Singapore: +65 6779 9091  
fa-info@sg.pepperl-fuchs.com

**PF** PEPPERL+FUCHS

## Technical Data

Light source	IRED	
Light type	modulated infrared light	
Diameter of the light spot	approx. 1000 mm at 1.5 m	
Angle of divergence	± 20 °	
Ambient light limit	5000 Lux	
Cycle time	35 ms	
<b>Functional safety related parameters</b>		
MTTF <sub>d</sub>	200 a	
Mission Time (T <sub>M</sub> )	20 a	
Diagnostic Coverage (DC)	0 %	
<b>Indicators/operating means</b>		
Operation indicator	LED green	
Data flow indicator	Inputs: 8 LEDs green Outputs: 8 LEDs red	
Control elements	sensitivity adjustment	
Control elements	Operating mode switch 4: Behavior when beam is broken Switches 1+2: Address	
<b>Electrical specifications</b>		
Operating voltage	U <sub>B</sub>	10 ... 30 V DC
No-load supply current	I <sub>0</sub>	40 mA
Data sampling blanking	Enable input emitter deactivation	
Data rate	225 Bit/s	
<b>Interface</b>		
Interface type	8 bit parallel, bidirectional 10 inputs, NPN ; 10 outputs, NPN	
<b>Output</b>		
Switching voltage	max. 30 V DC	
Switching current	max. 200 mA per channel , short-circuit protected , total max. 800 mA	
<b>Conformity</b>		
Product standard	EN 60947-5-2	
<b>Approvals and certificates</b>		
EAC conformity	TR CU 020/2011	
Approvals	CE	
<b>Ambient conditions</b>		
Ambient temperature	-20 ... 60 °C (-4 ... 140 °F)	
Storage temperature	-20 ... 75 °C (-4 ... 167 °F)	
<b>Mechanical specifications</b>		
Housing width	53 mm	
Housing depth	56 mm	
Degree of protection	IP67	
Connection	2 M16 cable glands, tension spring terminals in the terminal compartment	
<b>Material</b>		
Housing	Terluran®, black	
Optical face	glass	
Mass	170 g	

Release date: 2021-11-25 Date of issue: 2021-11-25 Filename: 120841\_eng.pdf

Connection Assignment

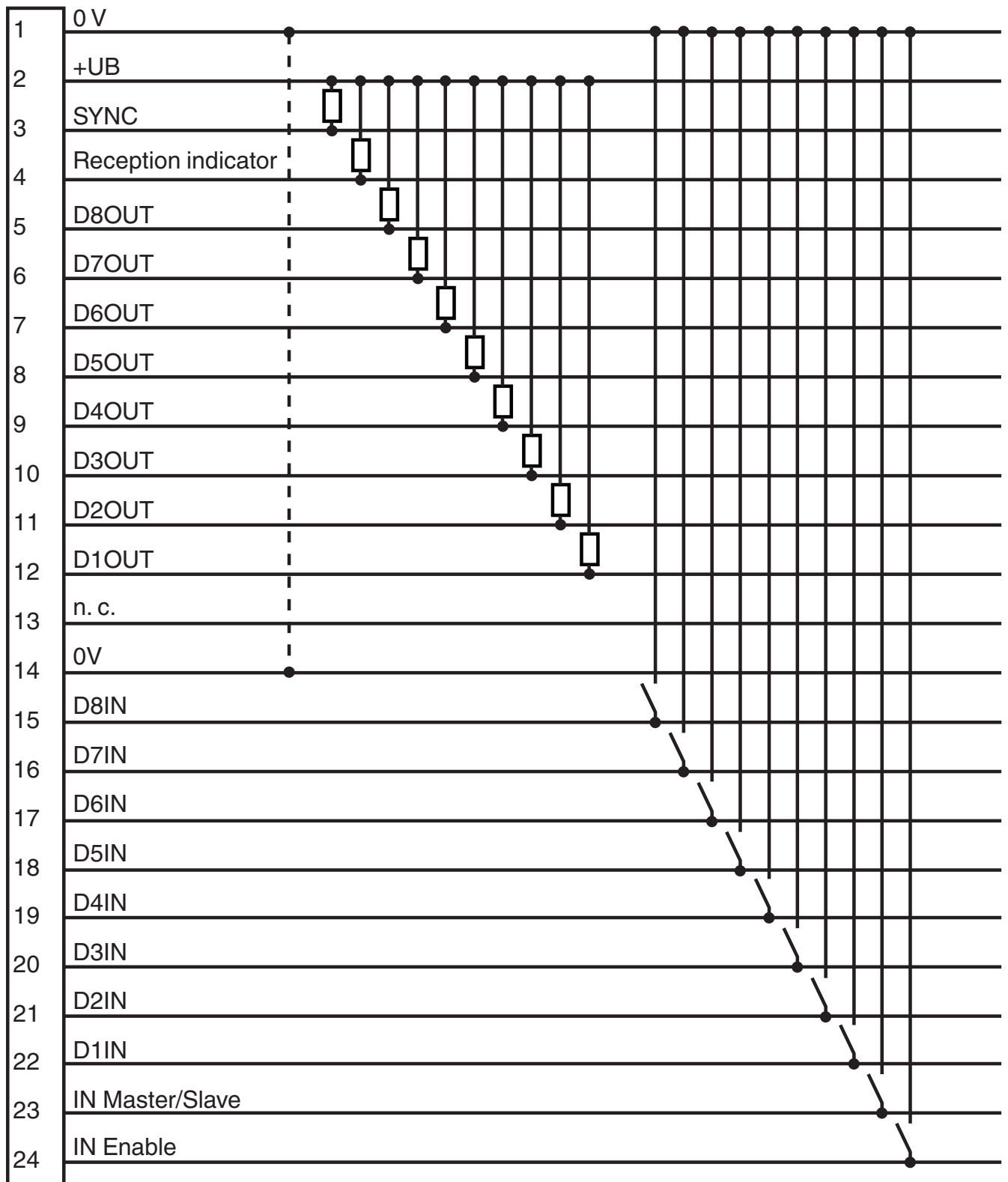

Release date: 2021-11-25 Date of issue: 2021-11-25 Filename: 120841\_eng.pdf

Refer to "General Notes Relating to Pepperl+Fuchs Product Information".

## Characteristic Curve

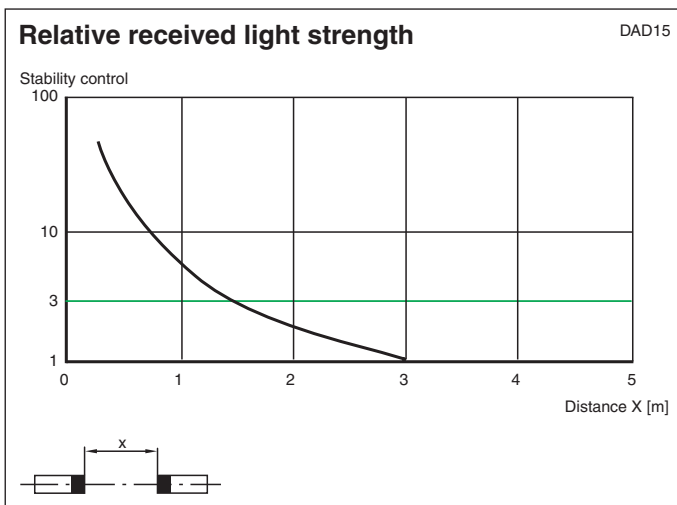
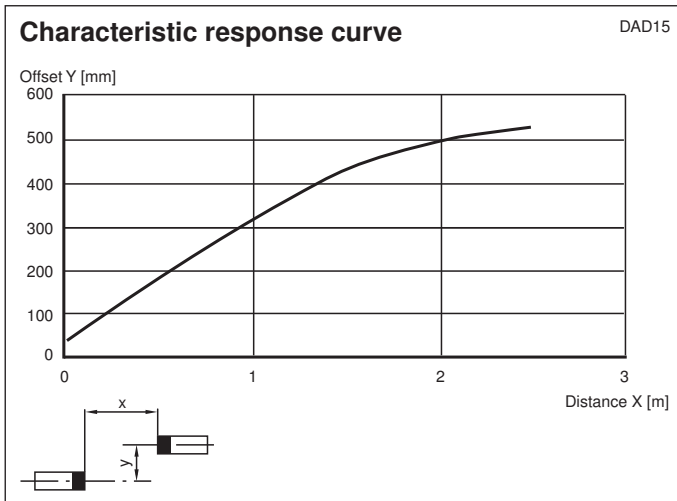

## Accessories

	<b>OMH-DAD10</b>	Mounting bracket
--	------------------	------------------

Release date: 2021-11-25 Date of issue: 2021-11-25 Filename: 120841\_eng.pdf

**Additional Information**

**Function**

The DAD15-8P-NPN can be used to transfer data words eight bits wide bidirectionally. A device pair is required to set up a transmission route. One device is operated as the MASTER (low level on the Master/Slave input) and the second one as the SLAVE (high level on the Master/Slave input). All binary control signals present in parallel on inputs D1 - D8 are converted serially into an 8-bit sequence in the device, are transferred over the light route and are again applied in parallel in the receiver to outputs D1 - D8. Interference-resistant PPM modulation is used to transfer binary signals. The entire cycle during which the two current 8-bit words are transferred one after the other in both directions, in the time multiplex procedure, lasts 35 ms. This corresponds to a data rate of 350 Baud. This time multiplex procedure is of no significance to the user, since the last data to be received is stored and is available on the outputs until the next change is made.

**Output behaviour when the beam of light is interrupted**

The behaviour of the data outputs when the light beam is broken can be adjusted with the aid of the 4 switch (data latch):  
 OFF: Data outputs are turned off when the light beam is broken.  
 ON: The last data to be received remains intact on the outputs when the light beam is broken.

**Input/output / emitter deactivation**

A low level on the ENABLE input is required to operate the DAD15-8P-NPN. If there is a high level on the ENABLE input, the emitter will be turned off. The ENABLE input has no function in SLAVE mode.

**Inputs and outputs, reception indicator:**

The states of data inputs and outputs are displayed individually via LEDs. A low level on the input is indicated by a green LED. A red LED indicates an active output. Correct reception is indicated with the output and the RECEPTION INDICATOR LED. The SYNC output indicates the end of a transmit or receive cycle. Output data are valid with a ascending edge and new input data can be read.

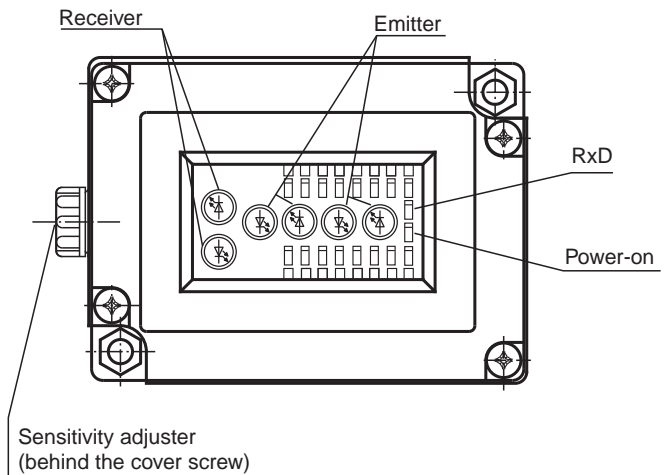

**Chaining**

The SYNC output can also be used to start an additional ENABLE input. Up to four MASTERS can be chained together in this manner. The devices must then be addressed by means of the A1 and A2 address switches. The SLAVE belonging to the MASTER in question requires the same address switch setting.

**Arrangement and mounting**

The DAD15 data light barrier consists of an electronics unit with spring-loaded terminals and 2 M16 cable glands. The electronics unit is connected with an internal connector. It is also fastened to it with 4 screws.

**Accessories:**

OMH-DAD10 mounting angle

**Timing**

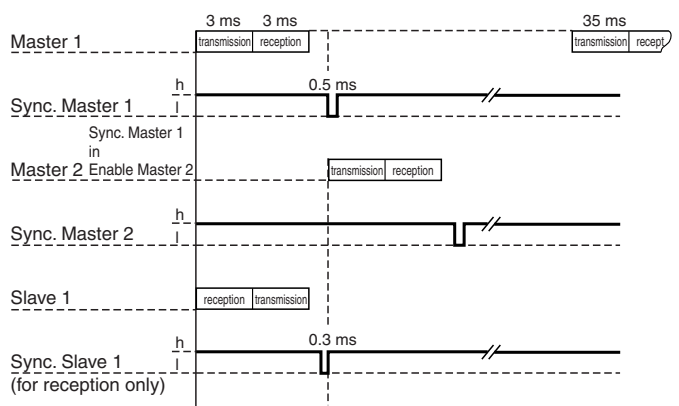

Release date: 2021-11-25 Date of issue: 2021-11-25 Filename: 120841\_eng.pdf