

Inductive sensor

NCB1,5-12GM85-E2-D-V1



- 1.5 mm flush
- Operating pressure 500 bar, peak pressure 1000 bar
- For applications in hydraulic cylinder



Dimensions

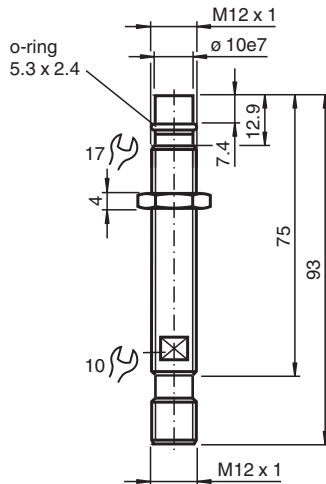

Technical Data

General specifications		
Switching function		Normally open (NO)
Output type		PNP
Rated operating distance	s_n	1.5 mm
Installation		flush
Output polarity		DC
Output type		3-wire
Nominal ratings		
Operating voltage	U_B	10 ... 30 V DC
Switching frequency	f	0 ... 600 Hz
Hysteresis	H	typ. 8 %
Reverse polarity protection		reverse polarity protected
Short-circuit protection		pulsing
Voltage drop	U_d	≤ 2 V
Operating current	I_L	0 ... 200 mA
No-load supply current	I_0	≤ 10 mA
Limit data		

Release date: 2022-05-18 Date of issue: 2022-05-18 Filename: 123395_eng.pdf

Refer to "General Notes Relating to Pepperl+Fuchs Product Information".

Pepperl+Fuchs Group
www.pepperl-fuchs.com

USA: +1 330 486 0001
fa-info@us.pepperl-fuchs.com

Germany: +49 621 776 1111
fa-info@de.pepperl-fuchs.com

Singapore: +65 6779 9091
fa-info@sg.pepperl-fuchs.com

PF PEPPERL+FUCHS

Technical Data

Operating pressure	500 bar (7252 psi)
Peak pressure	1000 bar (14504 psi)
Functional safety related parameters	
MTTF _d	728 a
Mission Time (T _M)	20 a
Diagnostic Coverage (DC)	0 %
Compliance with standards and directives	
Standard conformity	
Standards	EN 60947-5-2:2007 IEC 60947-5-2:2007
Approvals and certificates	
UL approval	cULus Listed, General Purpose
CSA approval	cCSAus Listed, General Purpose
CCC approval	CCC approval / marking not required for products rated ≤36 V
Ambient conditions	
Ambient temperature	-25 ... 100 °C (-13 ... 212 °F)
Mechanical specifications	
Connection type	Connector plug M12 x 1 , 4-pin
Housing material	Stainless steel 1.4305 / AISI 303
Sensing face	Ceramic
Degree of protection	IP68
Mass	42 g

Connection

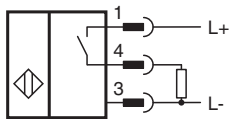

Connection Assignment

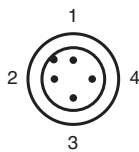

Wire colors in accordance with EN 60947-5-2

1	BN	(brown)
2	WH	(white)
3	BU	(blue)
4	BK	(black)

Installation Conditions

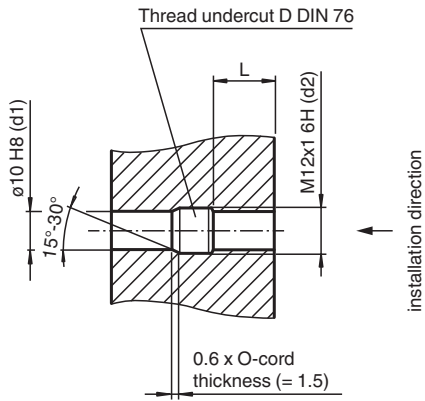

L: recommended installation depth: $L \geq 0.8 \times d2$

Accessories

	V1-G-2M-PUR	Female cordset single-ended M12 straight A-coded, 4-pin, PUR cable grey
	V1-W-2M-PUR	Female cordset single-ended M12 angled A-coded, 4-pin, PUR cable grey