

Ultrasonic sensor

UB2000-F42-E6-V15

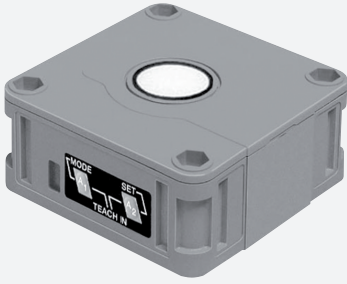

- 2 independent switch outputs
- Extremely small unusable area
- TEACH-IN
- Interference suppression (adjustable divergence of sound cone in close range)
- Temperature compensation
- Synchronization options
- NO/NC selectable

Single head system



Dimensions

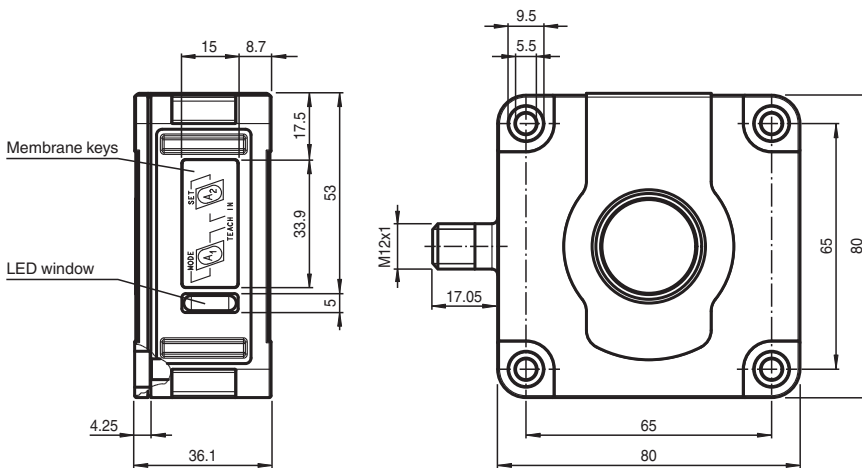

Technical Data

General specifications

Sensing range	60 ... 2000 mm
Adjustment range	90 ... 2000 mm
Dead band	0 ... 60 mm
Standard target plate	100 mm x 100 mm
Transducer frequency	approx. 175 kHz
Response delay	approx. 150 ms

Indicators/operating means

LED green	solid green: Power on
-----------	-----------------------

Release date: 2023-02-15 Date of issue: 2023-02-15 Filename: 133988_eng.pdf

Refer to "General Notes Relating to Pepperl+Fuchs Product Information".

Pepperl+Fuchs Group
www.pepperl-fuchs.com

USA: +1 330 486 0001
fa-info@us.pepperl-fuchs.com

Germany: +49 621 776 1111
fa-info@de.pepperl-fuchs.com

Singapore: +65 6779 9091
fa-info@sg.pepperl-fuchs.com

PF PEPPERL+FUCHS

Technical Data

LED yellow 1		solid: switching state switch output 1 flashing: program function
LED yellow 2		solid: switching state switch output 2 flashing: program function
LED red		normal operation: "fault" program function: no object detected
Electrical specifications		
Operating voltage	U_B	10 ... 30 V DC , ripple 10 % _{SS}
No-load supply current	I_0	≤ 50 mA
Input/Output		
Synchronization		bi-directional 0 level: $-U_B \dots +1$ V 1 level: $+4$ V $\dots +U_B$ input impedance: > 12 KOhm synchronization pulse: ≥ 100 μs, synchronization interpulse period: ≥ 2 ms
Synchronization frequency		
Common mode operation		max. 30 Hz
Multiplex operation		≤ 30/n Hz, n = number of sensors
Output		
Output type		2 switch outputs PNP, NO/NC selectable
Rated operating current	I_e	200 mA , short-circuit/overload protected
Default setting		Switch point A1: 90 mm , Switch point A2: 2000 mm , wide sound lobe
Voltage drop	U_d	≤ 2.5 V
Repeat accuracy		≤ 0.5 % of switching point
Switching frequency	f	≤ 2.7 Hz
Range hysteresis	H	1 % of the set operating distance
Temperature influence		± 1 % of full-scale value
Compliance with standards and directives		
Standard conformity		
Standards		EN IEC 60947-5-2:2020 IEC 60947-5-2:2019
Approvals and certificates		
UL approval		cULus Listed, Class 2 Power Source
CCC approval		CCC approval / marking not required for products rated ≤36 V
Ambient conditions		
Ambient temperature		-25 ... 70 °C (-13 ... 158 °F)
Storage temperature		-40 ... 85 °C (-40 ... 185 °F)
Mechanical specifications		
Connection type		Connector plug M12 x 1 , 5-pin
Degree of protection		IP54
Material		
Housing		ABS
Transducer		epoxy resin/hollow glass sphere mixture; foam polyurethane, cover PBT
Mass		140 g

Connection

Standard symbol/Connections:
(version E6, pnp)

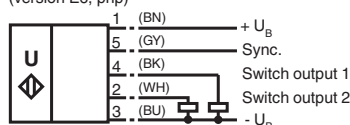

Core colours in accordance with EN 60947-5-2.

Connection Assignment



Wire colors in accordance with EN 60947-5-2

1	BN	(brown)
2	WH	(white)
3	BU	(blue)
4	BK	(black)
5	GY	(gray)

Characteristic Curve

Characteristic response curve

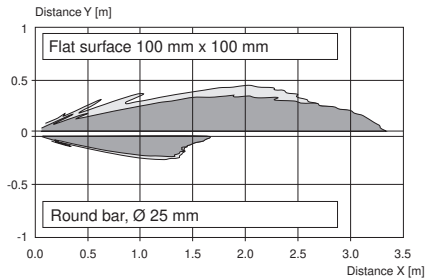

Switching output programming

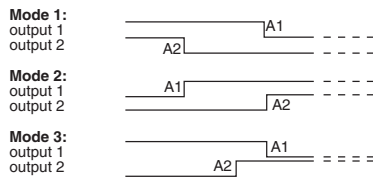
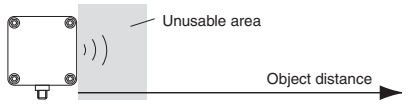

A1 → ∞ , A2 → ∞ : Object presence detection.
Both outputs operate according to the selected mode, if an object is located within the detection range.

Window and Switching point:

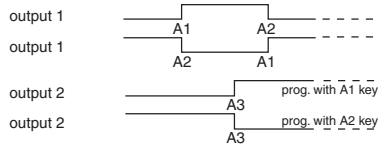





Note:

→ ∞ means: cover transducer surface with your hand, while programming the output.
If A1 = A2, the output work like A1 < A2

Release date: 2023-02-15 Date of issue: 2023-02-15 Filename: 133988_eng.pdf

Accessories

	MH 04-3505	Mounting aid for FP and F42 sensors
	MHW 11	Mounting brackets for sensors
	V15-G-2M-PVC	Female cordset single-ended M12 straight A-coded, 5-pin, PVC cable grey
	V15-W-2M-PUR	Female cordset single-ended M12 angled A-coded, 5-pin, PUR cable grey

Release date: 2023-02-15 Date of issue: 2023-02-15 Filename: 133988_eng.pdf

Refer to "General Notes Relating to Pepperl+Fuchs Product Information".

Pepperl+Fuchs Group
www.pepperl-fuchs.com

USA: +1 330 486 0001
fa-info@us.pepperl-fuchs.com

Germany: +49 621 776 1111
fa-info@de.pepperl-fuchs.com

Singapore: +65 6779 9091
fa-info@sg.pepperl-fuchs.com

Programming

Functional description

The sensor can be completely parameterised using 2 keys on the side of the housing. One special feature of this sensor is the option of adapting the ultrasonic beam width to the ambient conditions at the place where the sensor is used.

Teach-in of switching points:

Teach-in of switching points is used to determine the points at which the switching outputs will change their state. In addition, the order of switching points $A1 < A2$, or $A1 > A2$ also determines the effective direction (normally closed/open function) of the window in the output function (operating mode) "Window + Switching point" (see below).

Teach-in of switching point A1 with key A1	
Press key A1 > 2 seconds	The sensor goes into learning mode for switching point A1
Position the target object at the desired distance	The sensor indicates by rapid flashing of the yellow LED that the target object has been detected. If no object is detected, the red LED flashes.
Press key A1 briefly	The sensor completes the Teach-in process for switching point A1 and stores the value in permanent memory. If the object is uncertain (red LED lit irregularly) the Teach-in value is not valid. Teach-in mode closes.

The process for Teach-in of switching point A2 is similar to what was described above, using key A2.

Special feature for output function "Window + switching point"

In the case of the output function (operating mode) "Window + switching point" (see below), switching points A1 and A2 define the window limits of switch output 1.

A third switching point A3 can also be defined here at which switch output 2 switches.

Teach-in of switching point A3 with keys A1 and A2 (only for operating mode window + switching point, see below)	
Press key A1 + A2 > 2 seconds	The sensor goes into learning mode for switching point A3
Position the target object at the desired distance	The sensor indicates by rapid flashing of the yellow LEDs that the target object has been detected. If no object is detected, the red LED flashes.
Press key A1 briefly (output 2: normally closed) or Press key A2 briefly (output 2: normally open)	The sensor completes the Teach-in process for switching point A3 and stores the value in permanent memory. If the object is uncertain (red LED lit irregularly) the Teach-in value is not valid. Teach-in mode closes.



Teach-in for switching points can only be performed within the first 5 minutes after turning on the power supply. If the switching points need to be changed at a later time, this cannot be done until there is a new Power On.

Parameter assignment of the output function and ultrasound beam width

If you press the A1 key while the power supply is being turned on and then hold it down for 1 second, the sensor goes into the two-level parameterisation of operating modes.

Level 1, parametrisation of the output function

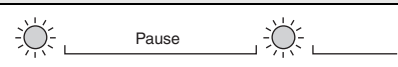
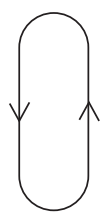
Pressing the A2 key briefly will cause the possible output functions to be selected one after the other (depending on the last output function to be parameterised). The functions are indicated by a flashing sequence of the green LED.

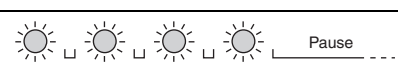
Operating mode	Flashing sequence of green LED	A2 key
2 x normally open function (default)		
2 x normally closed function		
2 switching points n.o. (output 1) + n.c. (output 2)		
Window (output 1) + switching point (output 2)		

Pressing the A1 key for 2 seconds saves the selected output operating mode. The parameter assignment process is then complete and the sensor returns to normal mode. If you press the A1 key briefly instead, you go to Level 2 (parameter assignment of ultrasonic beam range).



Level 2, parameter assignment of ultrasonic beam width

The ultrasonic beam width can be adjusted to match the requirements of the application in Level 2.

Pressing the A2 key briefly will cause the possible beam widths to be selected one after the other (depending on the last beam width to be parameterised). The functions are indicated by a flashing sequence of the red LED.

Release date: 2023-02-15 Date of issue: 2023-02-15 Filename: 133988_eng.pdf

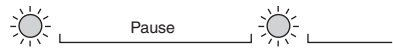
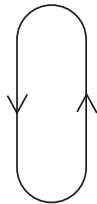
Refer to "General Notes Relating to Pepperl+Fuchs Product Information".

Beam width	Flashing sequence of red LED	A2 key
Narrow beam width		
Average beam width		
Wide beam (default)		

Pressing the A1 key for 2 seconds saves the selected type of beam width. The parameter assignment process is then complete and the sensor returns to normal mode. If you press the A1 briefly instead, you go back to Level 1 (parameter assignment of output function).

If parameterisation is not complete within 5 minutes (pressing the A1 key for 2 seconds), the sensor interrupts parameterisation mode without changing the settings.

Synchronisation

The sensor is equipped with a synchronisation connection to suppress mutual interaction. If it is not turned on, the sensor works at an internally generated cycle rate. Synchronisation of more than one sensor is possible in a number of different ways.

External synchronisation:

The sensor can be synchronised by the application of a square wave voltage externally. A synchronisation pulse on the synchronisation input results in the execution of a measurement cycle. The pulse width must be greater than 100 µs. The measurement cycle must be started with the falling signal edge. A Low level > 1 s or an open synchronisation input results in normal operation of the sensor. A High level on the synchronisation input deactivates the sensor.

Two different operating modes are possible

- Multiple sensors can be controlled by the same synchronisation signal. The sensors work on synonymous cycle.
- Synchronisation pulses are sent cyclically to only one sensor each time. The sensors work in Multiplex mode.

Self synchronisation:

The synchronisation connections of up to 5 sensors with option for self-synchronisation are connected with each other. These sensors work after turning on the operating voltage in Multiplex mode. The On delay increases depending on the number of sensors to be synchronised. Synchronisation is possible during Teach-in and vice-versa. Sensors must be operated unsynchronised to perform Teach-in of switching points.

Note:

If the option for synchronisation is not used, the synchronisation input can be connected with ground (0 V) or the sensor can be operated with a V1 connection cable (4-pin).

Release date: 2023-02-15 Date of issue: 2023-02-15 Filename: 133988_eng.pdf