

## Elevator light grid

AL2109-P-1820-3449/25/32/143

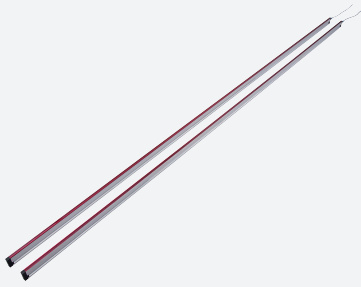

- Low-profile, high resolution light grid for monitoring locking edges on elevators and accesses
- Dense monitoring field with up to 135 beams ensures that small objects are detected
- Object detection up to distance of zero
- Automatic beam crossing and beam suppression
- Insensitive to reflection and ambient light
- In accord with EN81-70 and EN12015/16

High-resolution light grid for detecting people and objects, set comprising emitter and receiver, field height: 1800 mm, light on, PNP output, M8 plug



### Function

The AL2109 elevator light grid is used to protect elevator doors or for passenger monitoring and access control. Its special features include its dynamic beam crossover with up to 135 active sensors, object detection down to nearly zero millimeters and an ambient light limit greater than 100,000 Lux. The evaluation electronics and the power supply are completely integrated into the emitter and receiver element, so that no external equipment is necessary for operation. The system offers flexible mounting options and meets the newest standards in accordance with EN 81-70 and EN 12016.

## Dimensions

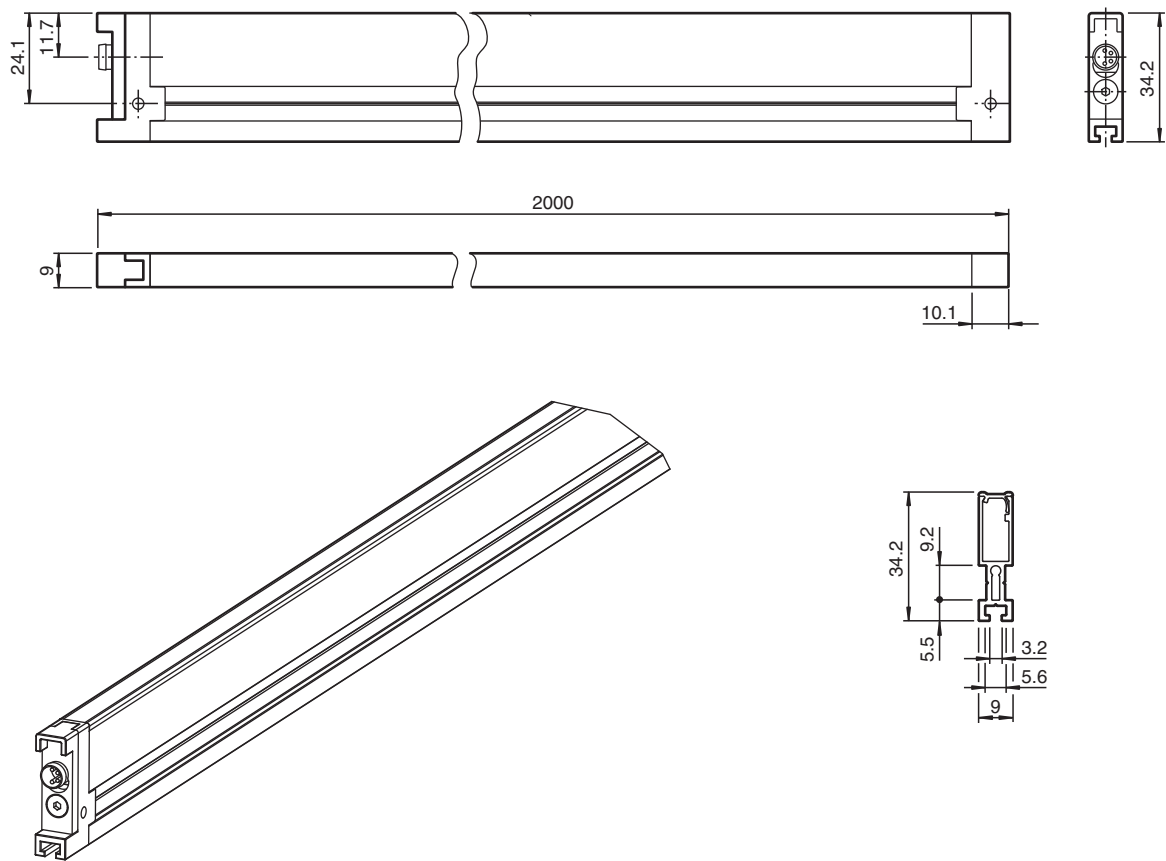

## Technical Data

### General specifications

Effective detection range	0 ... 3500 mm
Threshold detection range	3500 mm
Light source	IREDD
Light type	modulated infrared light , 950 nm
Field height	1800 mm
Beam crossover	automatic, 3x/5x/7x (depending on distance between transmitter/receiver)
Beam blanking	Defective beams are faded out after 60 s. Deactivation of the light grid upon failure of 2 adjacent beams or more than 50 % of all beams
Beam spacing	90 mm
Number of beams	61 ... 135 (dynamic)
Angle of divergence	Emitter: < 20 ° , Receiver: < 6 °
Ambient light limit	> 100000 Lux
Accessories provided	2 connecting cable , length 5 m (15 ft)

### Functional safety related parameters

MTTF <sub>d</sub>	180 a
Mission Time (T <sub>M</sub> )	20 a
Diagnostic Coverage (DC)	0 %

### Indicators/operating means

Function indicator	LED red (in receiver): Illuminates after connecting operating power, out when object is detected, flashes in case of permanent interruption of 2 neighbouring beams
--------------------	---

### Electrical specifications

Operating voltage	U <sub>B</sub>	11 ... 30 V DC
-------------------	----------------	----------------

## Technical Data

Ripple		10 %
No-load supply current	$I_0$	< 180 mA
<b>Output</b>		
Switching type		light on
Signal output		PNP short-circuit protected
Switching voltage		max. 30 V DC
Switching current		100 mA
Switching frequency	f	< 3 Hz
Response time		< 100 ms
<b>Compliance with standards and directives</b>		
Directive conformity		
EMC Directive 2004/108/EC		EN 12015:2014 EN 12016:2013
Standard conformity		
Product standard		EN 60947-5-2:2007 EN 60947-5-2/A1:2012 IEC 60947-5-2 Edition 3.1:2012-09
Standards		EN 81-70:2003-05 EN 81-70/A1:2004-12 EN 81-1+A3:2009-12; Chapter 7.5.2.1.1.3 Taking into account object detection in accordance with the data sheet specification for the monitoring field.
<b>Approvals and certificates</b>		
CE conformity		yes
CCC approval		CCC approval / marking not required for products rated $\leq 36$ V
<b>Ambient conditions</b>		
Ambient temperature		-20 ... 60 °C (-4 ... 140 °F)
Storage temperature		-20 ... 65 °C (-4 ... 149 °F)
<b>Mechanical specifications</b>		
Degree of protection		IP54
Connection		M8 x 1 connector, 4-pin
Material		
Housing		aluminum
Optical face		plastic
Mass		2000 g (device)

## Connection Assignment

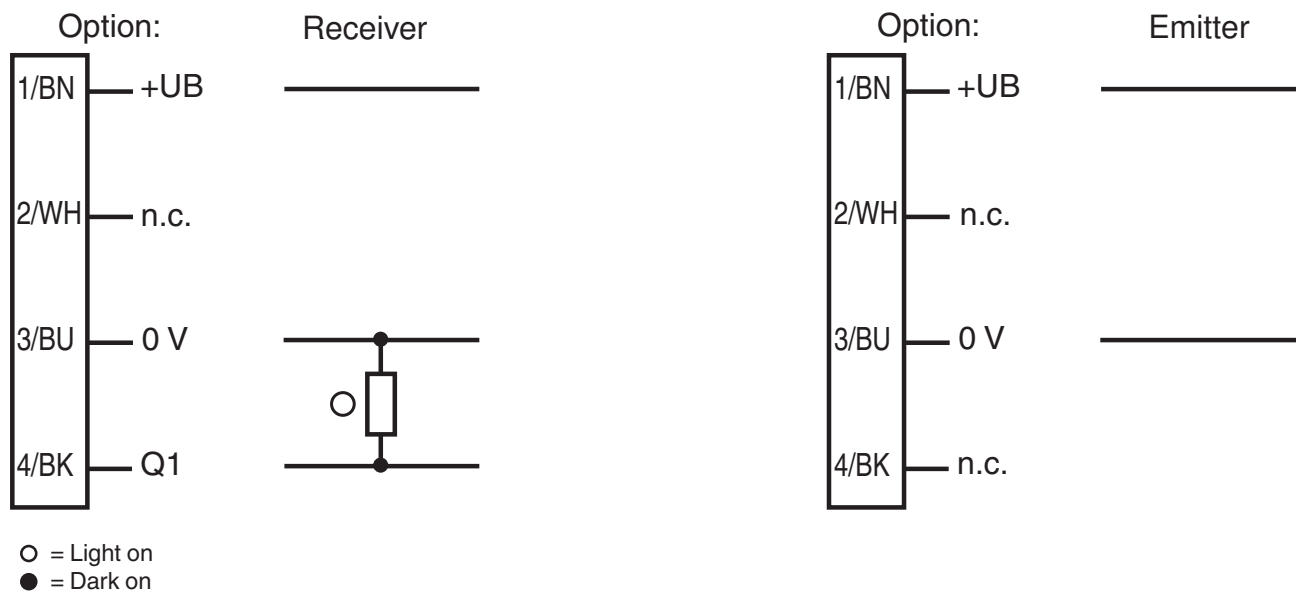

Release date: 2020-10-08 Date of issue: 2020-10-08 Filename: 191186\_eng.pdf

## Assembly

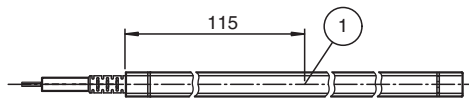



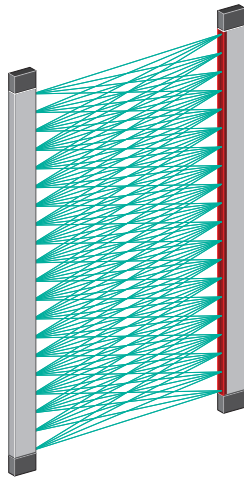

1 LED display

## Application



## Accessories

	<b>Mounting Set AL2109 back board</b>	Mounting aid
	<b>Mounting Set AL2109 extension</b>	Mounting aid
	<b>Mounting Set AL2109 lateral</b>	Mounting aid
	<b>PS1/31</b>	Power supply/Power supply module

Release date: 2020-10-08 Date of issue: 2020-10-08 Filename: 191186\_eng.pdf

## Monitoring field

Object detection

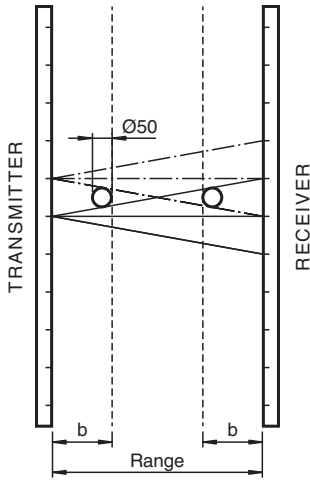

Range [mm]	b [mm]
100	38
200	64
300	88
400	64
500	76
600	88
700	72
800	80
900	88
1000	96
1500	134
2000	171
2500	209
3000	246
3500	283

## Accessories

Other suitable accessories can be found at [www.pepperl-fuchs.com](http://www.pepperl-fuchs.com)

## LED Indicators

The red LED in the upper end of the receiver lights up continuously when the operating voltage is applied. The light grid is then ready for operation.

When an object is detected, the red LED goes out until the light beams are unobstructed again.

The AL2109 elevator light grid features a beam suppression system. If one of the 21 emitters or receivers is covered on a sustained basis (e.g. by dirt or other contaminants), the beam in question is removed from the evaluation after 60 seconds, and the light grid remains ready for operation. The light grid is deactivated if 2 adjacent beams or more than half of all the beams fail; in this case, the red LED flashes.

## Operating Modes

### Light ON:

Light ON means that the outputs are active if none of the light beams are broken.

## Monitoring field

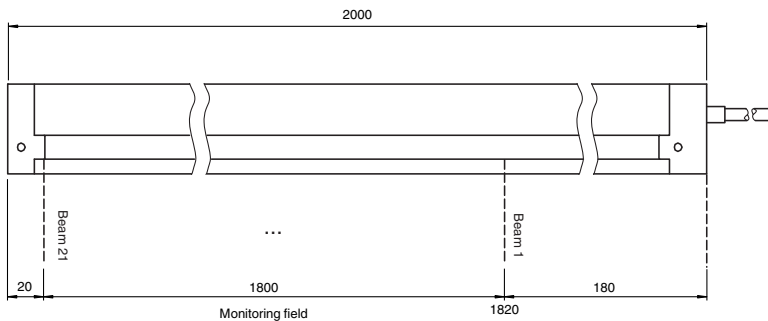

## Function Principle

The AL2109 light grid is used for access monitoring on elevators. The device consists of an emitter and receiver unit. The evaluation electronics and power supply are integrated into the devices. No additional external components are required for operation.

Release date: 2020-10-08 Date of issue: 2020-10-08 Filename: 191186\_eng.pdf

By default, the light grid automatically switches between 7-way, 5-way and 3-way crossovers. If the distance is more than 0.8 m between the emitter and receiver, the light grid selects the "7-way crossover" operating mode. Every receiver evaluates the beams of 7 emitters in this mode. 7-way crossover thus increases the resolution to 135 beams.

### Application

- Secure and complete monitoring of elevator doors
- Monitoring of access systems and entrances
- Access control