



Safety light curtain

SLC14-150/151



- Sensing range up to 5 m
- Resolution 14 mm (finger protection)
- Self-monitoring (type 4 according to IEC/EN 61496-1)
- Master/Slave detection, Plug and Play
- Start/Restart disable
- Degree of protection IP67
- Integrated function display
- Pre-fault indication
- Optional with relay monitor (Option 129)
- Connection via appliance socket M12 x b1
- Safety outputs OSSD in potential-separated semiconductor version
- Protective field height up to 1800 mm



Dimensions

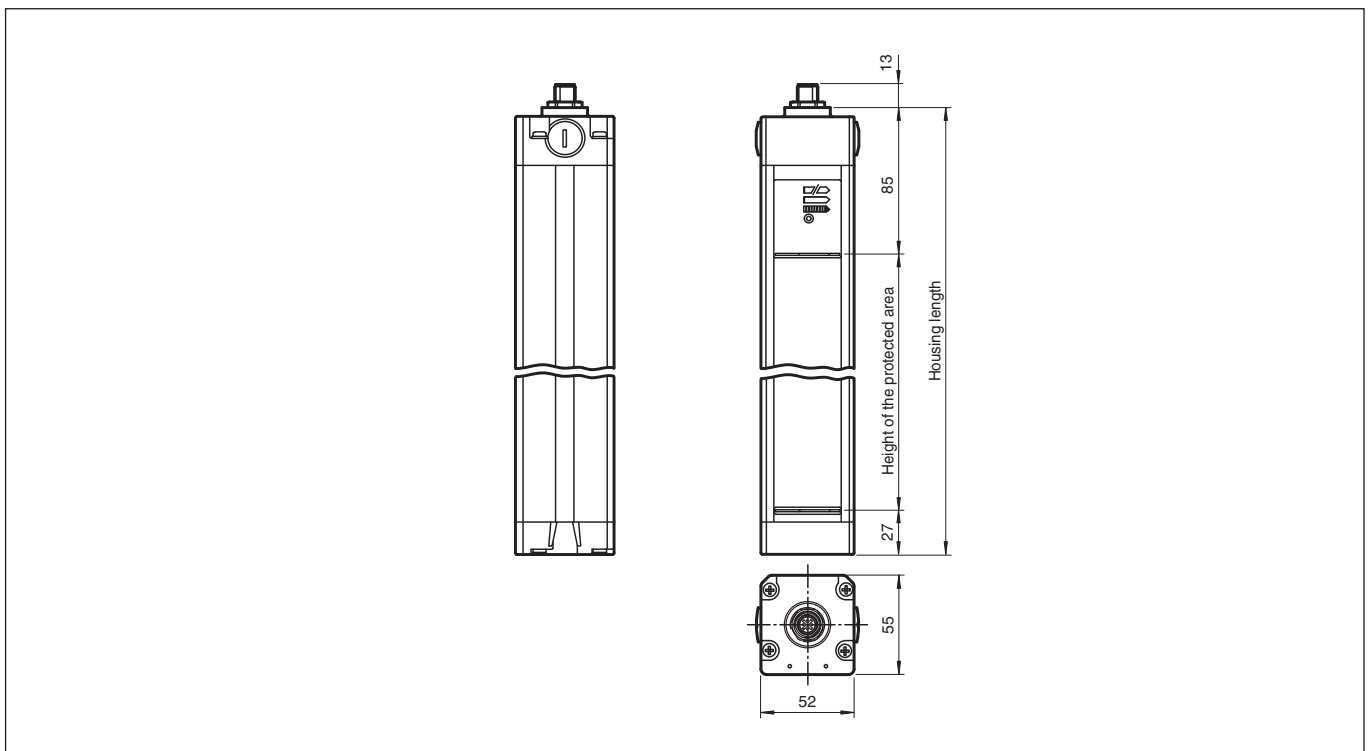

Technical Data

System components	
Emitter	SLC14-150-T/92
Receiver	SLC14-150-R/151
General specifications	
Effective detection range	0.2 ... 5 m
Light source	IRED
Light type	modulated infrared light
LED risk group labelling	exempt group

Release date: 2020-03-23 Date of issue: 2020-10-06 Filename: 199718_eng.pdf

Refer to "General Notes Relating to Pepperl+Fuchs Product Information".

Pepperl+Fuchs Group
www.pepperl-fuchs.com

USA: +1 330 486 0001
fa-info@us.pepperl-fuchs.com

Germany: +49 621 776 1111
fa-info@de.pepperl-fuchs.com

Singapore: +65 6779 9091
fa-info@sg.pepperl-fuchs.com

PEPPERL+FUCHS

Technical Data

Tests		IEC/EN 61496
Safety type according to IEC/EN 61496		4
Width of protected area		0.2 ... 5 m
Protection field height		150 mm
Number of beams		16
Operating mode		can be selected with or without start/restart disable
Optical resolution		14 mm
Angle of divergence		< 5 °
Functional safety related parameters		
Safety Integrity Level (SIL)		SIL 3
Performance level (PL)		PL e
Category		Cat. 4
Mission Time (T _M)		20 a
PFH _d		2.42 E-8
Type		4
Indicators/operating means		
Operation indicator		7-segment display in emitter
Diagnostics indicator		7-segment display in receiver
Function indicator		in receiver: LED red: OSSD off LED green: OSSD on LED yellow: Protected area free, system start-ready
Pre-fault indicator		LED orange
Control elements		switch for start/restart disable, transmission coding
Electrical specifications		
Operating voltage	U _B	24 V DC (-30 %/+25 %)
No-load supply current	I ₀	Emitter: ≤ 100 mA receiver: ≤ 150 mA
Protection class		III
Input		
Activation current		approx. 10 mA
Activation time		0.03 ... 1 s
Test input		Reset-input for system test (not for option /129)
Function input		Start release
Output		
Safety output		2 separated fail safe semiconductor outputs
Signal output		1 PNP, max. 100 mA for start readiness
Switching voltage		Operating voltage -2 V
Switching current		max. 0.5 A
Response time		10 ms
Conformity		
Functional safety		ISO 13849-1
Product standard		EN 61496-1 ; IEC 61496-2
Approvals and certificates		
CE conformity		CE
UL approval		cULus Listed
CCC approval		CCC approval / marking not required for products rated ≤36 V
TÜV approval		TÜV
Ambient conditions		
Ambient temperature		0 ... 55 °C (32 ... 131 °F)
Storage temperature		-25 ... 70 °C (-13 ... 158 °F)
Relative humidity		max. 95 %, not condensing
Mechanical specifications		
Housing length L		260 mm
Degree of protection		IP67

Release date: 2020-03-23 Date of issue: 2020-10-06 Filename: 199718_eng.pdf

Refer to "General Notes Relating to Pepperl+Fuchs Product Information".

Pepperl+Fuchs Group
www.pepperl-fuchs.comUSA: +1 330 486 0001
fa-info@us.pepperl-fuchs.comGermany: +49 621 776 1111
fa-info@de.pepperl-fuchs.comSingapore: +65 6779 9091
fa-info@sg.pepperl-fuchs.com

PEPPERL+FUCHS

Technical Data

Connection	Emitter: M12 connector, 4-pin Receiver: M12 connector, 8-pin
Material	
Housing	extruded aluminum profile, RAL 1021 (yellow) coated
Optical face	Plastic pane
Mass	Per 750 g

Connection Assignment

Emitter

Receiver

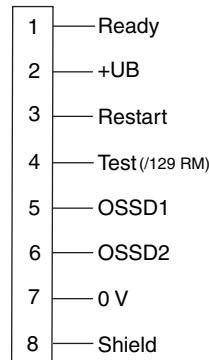
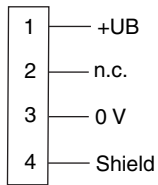

Connection Assignment

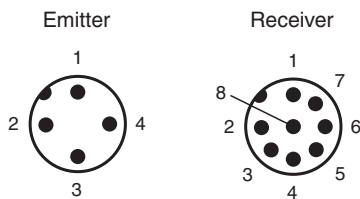

Release date: 2020-03-23 Date of issue: 2020-10-06 Filename: 199718_eng.pdf

Characteristic Curve

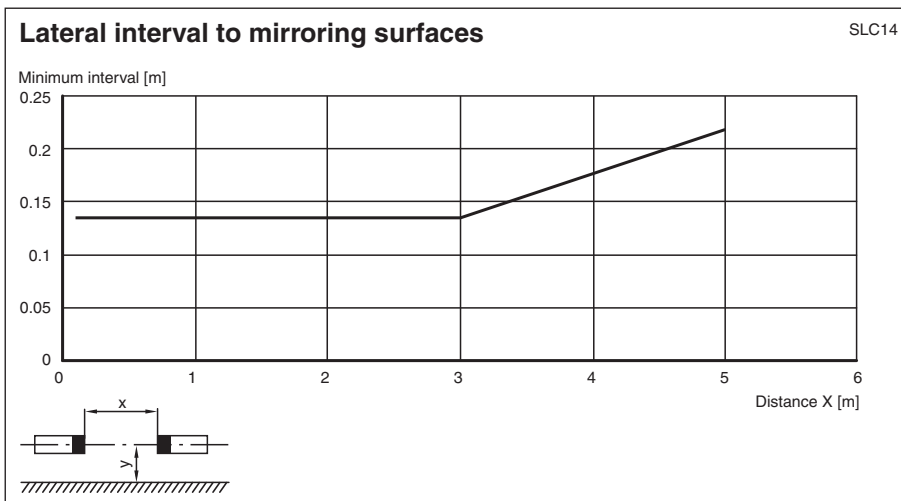
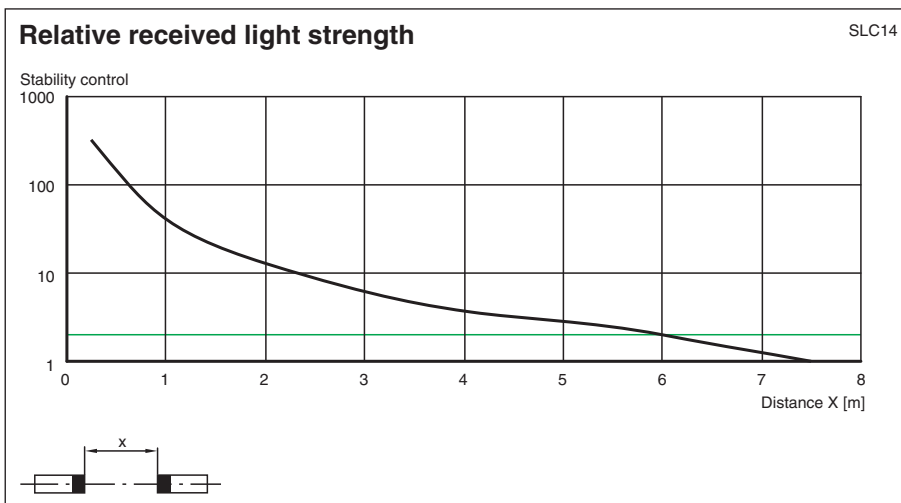
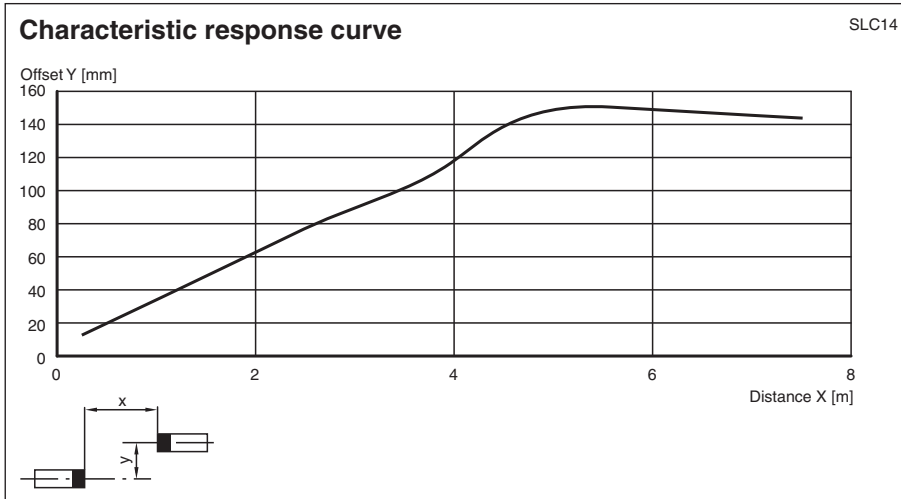

Matching system components

	SB4-OR-4XP-B-4159	Safety control unit
	SB4-OR-4XP	Safety control unit
	SB4-OR-4XP-B	SB4 series safety control unit with 1 optional module slot for functional enhancement







Release date: 2020-03-23 Date of issue: 2020-10-06 Filename: 199718_eng.pdf

Refer to "General Notes Relating to Pepperl+Fuchs Product Information".

Matching system components



	SB4-OR-4XP-B-B	SB4 series safety control unit with optional module slots for functional enhancement
	SB4-OR-4XP-B-B-B	SB4 series safety control unit with optional module slots for functional enhancement
	SB4-OR-4XP-B-B-B-B	SB4 series safety control unit with optional module slots for functional enhancement
	SB4-OR-4XP-B-B-B-B-B	SB4 series safety control unit with optional module slots for functional enhancement
	SB4-OR-4XP-B-4158	Safety control unit
	SB4-OR-4XP-3819	Safety control unit
	SB4-OR-4XP-4M	Safety control unit
	SB4-OR-4XP-4MD	Safety control unit
	SB4-OR-4XP-4M-4136	Safety control unit of series SB4
	SB4-OR-4XP-4X	Safety control unit
	SB4-OR-4XP-4X-3819	Safety control unit
	SB4-OR-4XP-4136	Safety control unit of series SB4

Accessories

	MS SLC	Mounting bracket for Light grid
	PA SLP/SLC	Alignment aid for SLP and SLC series profile light grids
	PG HOLDER SLC	Holders for SLC protective glass panes
	PG SLC-X	Protective glass panes for SLC series
	PG SLC-150	Protective glass panes for SLC series
	TC SLC (M16)	M16 cable gland
	UC SLP/SLC	Floor stand for all series SLP/SLC devices

Release date: 2020-03-23 Date of issue: 2020-10-06 Filename: 199718_eng.pdf

Accessories

	<p>UC SLP/SLC 1530 mm</p>	<p>Floor stand for all series SLP/SLC devices</p>
	<p>Damping UC SLP/SLC</p>	<p>Shock absorber as ramming protector for all series SLP/SLC devices</p>
	<p>Enclosure UC SLP/SLC</p>	<p>Housing for floor stand</p>

Release date: 2020-03-23 Date of issue: 2020-10-06 Filename: 199718_eng.pdf

Refer to "General Notes Relating to Pepperl+Fuchs Product Information".

Pepperl+Fuchs Group
www.pepperl-fuchs.com

USA: +1 330 486 0001
fa-info@us.pepperl-fuchs.com

Germany: +49 621 776 1111
fa-info@de.pepperl-fuchs.com

Singapore: +65 6779 9091
fa-info@sg.pepperl-fuchs.com

Notes

Master slave mode

Master: SLC...-... (semiconductor)
or
SLC...-.../31 (relay)
Slave: SLC...-...-S

Using slaves makes it possible to lengthen protective fields or to form protective fields that lie in more than just one level. When you select slaves that can be connected, you should take into consideration that the maximum number of 96 light rays must not be exceeded.

There are slaves for transmitters and receivers. These may simply be connected to the master light curtain. As many as 2 slaves may be connected respectively to the transmitter and receiver unit.

Installation:

1. The end cap should be screwed off for the light curtain (without cable gland).
2. The plug-in jumper on the connectors of the printed circuit board, which is now visible, should be removed.
3. The slave is designed so that the cap located on the cable connector can be plugged directly onto the open end of the light curtain with the printed circuit board.
4. After you have screwed on the connection cap, the system is complete.

System accessories

- Mounting set SLC
- Test rods SLC14/SLC30/SLC60
- Protective glass pieces for SLC (to protect the optically functional surface)
- Lateral screwed connection SLC
- Profile alignment aid
- Laser alignment aid SLC
- Mirror for SLC (for securing hazardous areas on multiple sides)
- Ground pillar UC SLP/SLC
- Housing for pillar
Enclosure UC SLP/SLC
- Collision protector
Damping UC SLP/SLC