



## Safety light curtain

### SLC14-900/151



- Sensing range up to 5 m
- Resolution 14 mm (finger protection)
- Self-monitoring (type 4 according to IEC/EN 61496-1)
- Master/Slave detection, Plug and Play
- Start/Restart disable
- Degree of protection IP67
- Integrated function display
- Pre-fault indication
- Optional with relay monitor (Option 129)
- Connection via appliance socket M12 x b1
- Safety outputs OSSD in potential-separated semiconductor version
- Protective field height up to 1800 mm



## Dimensions

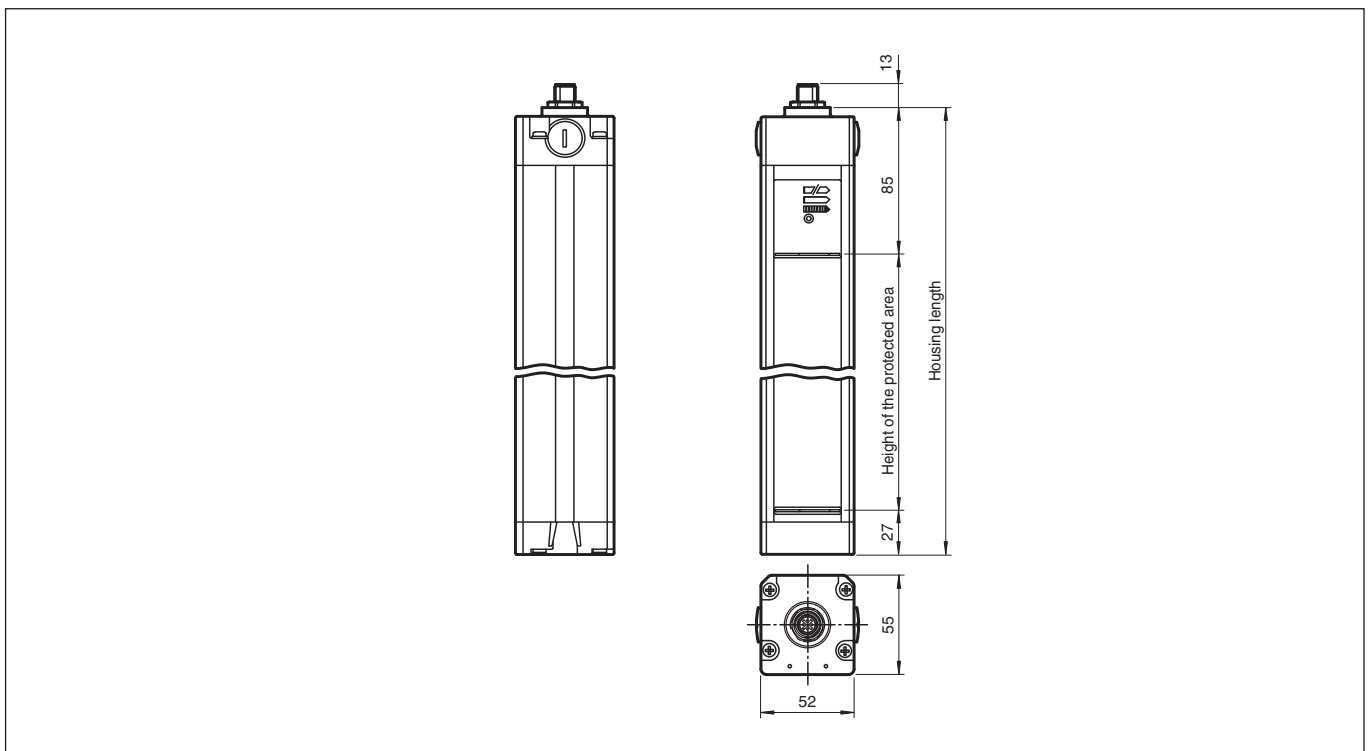

## Technical Data

System components	
Emitter	SLC14-900-T/92
Receiver	SLC14-900-R/151
General specifications	
Effective detection range	0.2 ... 5 m
Light source	IRED
Light type	modulated infrared light
LED risk group labelling	exempt group

Release date: 2020-03-23 Date of issue: 2020-10-06 Filename: 199728\_eng.pdf

Refer to "General Notes Relating to Pepperl+Fuchs Product Information".

Pepperl+Fuchs Group  
www.pepperl-fuchs.com

USA: +1 330 486 0001  
fa-info@us.pepperl-fuchs.com

Germany: +49 621 776 1111  
fa-info@de.pepperl-fuchs.com

Singapore: +65 6779 9091  
fa-info@sg.pepperl-fuchs.com

 PEPPERL+FUCHS

## Technical Data

Tests		IEC/EN 61496
Safety type according to IEC/EN 61496		4
Width of protected area		0.2 ... 5 m
Protection field height		900 mm
Number of beams		96
Operating mode		can be selected with or without start/restart disable
Optical resolution		14 mm
Angle of divergence		< 5 °
<b>Functional safety related parameters</b>		
Safety Integrity Level (SIL)		SIL 3
Performance level (PL)		PL e
Category		Cat. 4
Mission Time (T <sub>M</sub> )		20 a
PFH <sub>d</sub>		2.42 E-8
Type		4
<b>Indicators/operating means</b>		
Operation indicator		7-segment display in emitter
Diagnostics indicator		7-segment display in receiver
Function indicator		in receiver: LED red: OSSD off LED green: OSSD on LED yellow: Protected area free, system start-ready
Pre-fault indicator		LED orange
Control elements		switch for start/restart disable, transmission coding
<b>Electrical specifications</b>		
Operating voltage	U <sub>B</sub>	24 V DC (-30 %/+25 %)
No-load supply current	I <sub>0</sub>	Emitter: ≤ 100 mA receiver: ≤ 150 mA
Protection class		III
<b>Input</b>		
Activation current		approx. 10 mA
Activation time		0.03 ... 1 s
Test input		Reset-input for system test (not for option /129)
Function input		Start release
<b>Output</b>		
Safety output		2 separated fail safe semiconductor outputs
Signal output		1 PNP, max. 100 mA for start readiness
Switching voltage		Operating voltage -2 V
Switching current		max. 0.5 A
Response time		30 ms
<b>Conformity</b>		
Functional safety		ISO 13849-1
Product standard		EN 61496-1 ; IEC 61496-2
<b>Approvals and certificates</b>		
CE conformity		CE
UL approval		cULus Listed
CCC approval		CCC approval / marking not required for products rated ≤36 V
TÜV approval		TÜV
<b>Ambient conditions</b>		
Ambient temperature		0 ... 55 °C (32 ... 131 °F)
Storage temperature		-25 ... 70 °C (-13 ... 158 °F)
Relative humidity		max. 95 %, not condensing
<b>Mechanical specifications</b>		
Housing length L		1010 mm
Degree of protection		IP67

Release date: 2020-03-23 Date of issue: 2020-10-06 Filename: 199728\_eng.pdf

Refer to "General Notes Relating to Pepperl+Fuchs Product Information".

 Pepperl+Fuchs Group  
www.pepperl-fuchs.com

 USA: +1 330 486 0001  
fa-info@us.pepperl-fuchs.com

 Germany: +49 621 776 1111  
fa-info@de.pepperl-fuchs.com

 Singapore: +65 6779 9091  
fa-info@sg.pepperl-fuchs.com

 **PEPPERL+FUCHS**

### Technical Data

Connection	Emitter: M12 connector, 4-pin Receiver: M12 connector, 8-pin
Material	
Housing	extruded aluminum profile, RAL 1021 (yellow) coated
Optical face	Plastic pane
Mass	Per 3000 g

### Connection Assignment

Emitter

Receiver

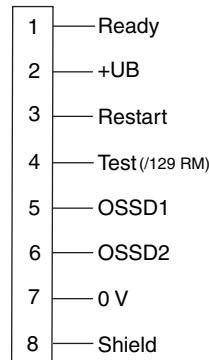
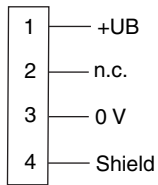

### Connection Assignment

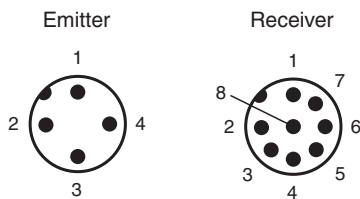

Release date: 2020-03-23 Date of issue: 2020-10-06 Filename: 199728\_eng.pdf

**Characteristic Curve**

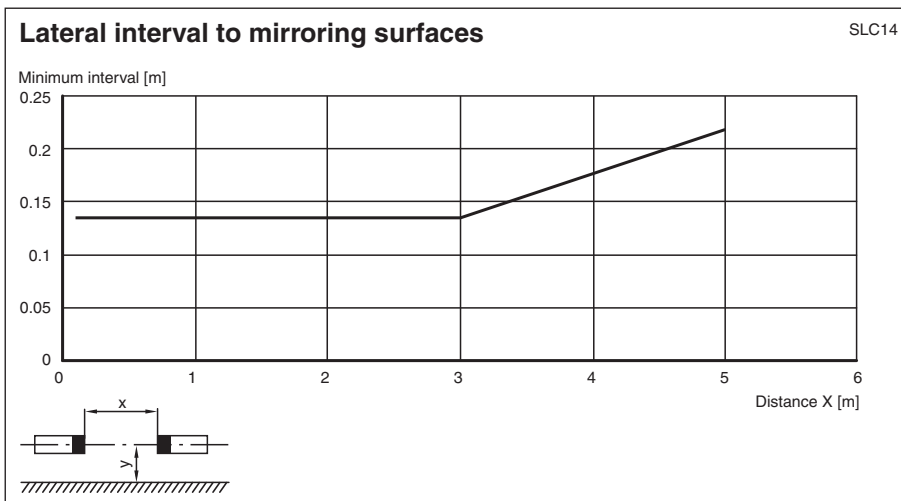
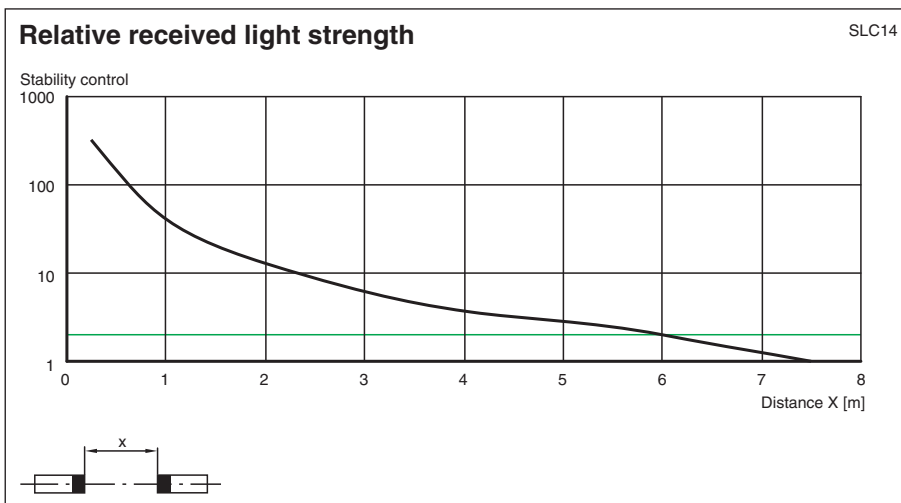
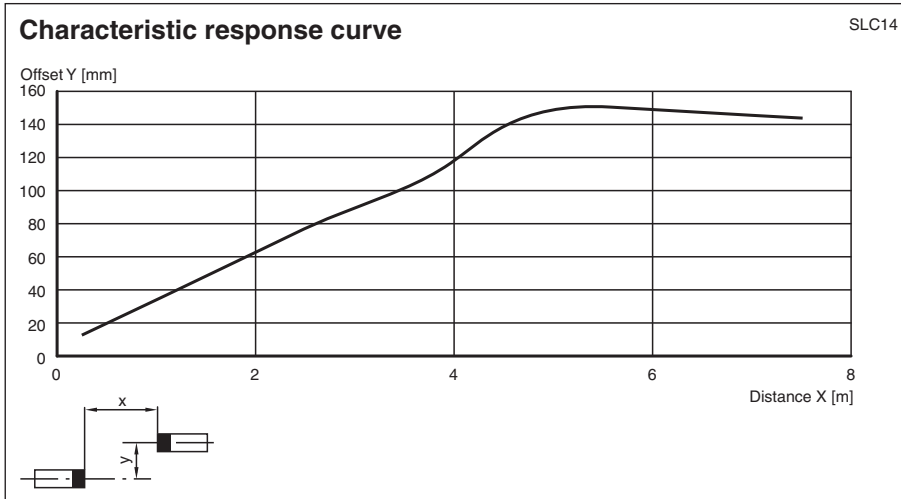

**Matching system components**

	<b>SB4-OR-4XP-B-4159</b>	Safety control unit
	<b>SB4-OR-4XP</b>	Safety control unit
	<b>SB4-OR-4XP-B</b>	SB4 series safety control unit with 1 optional module slot for functional enhancement

Release date: 2020-03-23 Date of issue: 2020-10-06 Filename: 199728\_eng.pdf

Refer to "General Notes Relating to Pepperl+Fuchs Product Information".

### Matching system components

	<b>SB4-OR-4XP-B-B</b>	SB4 series safety control unit with optional module slots for functional enhancement
	<b>SB4-OR-4XP-B-B-B</b>	SB4 series safety control unit with optional module slots for functional enhancement
	<b>SB4-OR-4XP-B-B-B-B</b>	SB4 series safety control unit with optional module slots for functional enhancement
	<b>SB4-OR-4XP-B-B-B-B-B</b>	SB4 series safety control unit with optional module slots for functional enhancement
	<b>SB4-OR-4XP-B-4158</b>	Safety control unit
	<b>SB4-OR-4XP-3819</b>	Safety control unit
	<b>SB4-OR-4XP-4M</b>	Safety control unit
	<b>SB4-OR-4XP-4MD</b>	Safety control unit
	<b>SB4-OR-4XP-4M-4136</b>	Safety control unit of series SB4
	<b>SB4-OR-4XP-4X</b>	Safety control unit
	<b>SB4-OR-4XP-4X-3819</b>	Safety control unit
	<b>SB4-OR-4XP-4136</b>	Safety control unit of series SB4

### Accessories

	<b>PG SLC-900</b>	Protective glass panes for SLC series
---	-------------------	---------------------------------------

Release date: 2020-03-23 Date of issue: 2020-10-06 Filename: 199728\_eng.pdf

Refer to "General Notes Relating to Pepperl+Fuchs Product Information".

Pepperl+Fuchs Group  
www.pepperl-fuchs.com

USA: +1 330 486 0001  
fa-info@us.pepperl-fuchs.com

Germany: +49 621 776 1111  
fa-info@de.pepperl-fuchs.com

Singapore: +65 6779 9091  
fa-info@sg.pepperl-fuchs.com

## Notes

### Master slave mode

Master: SLC..-... (semiconductor)  
or  
SLC..-.../31 (relay)  
Slave: SLC..-...-S

Using slaves makes it possible to lengthen protective fields or to form protective fields that lie in more than just one level. When you select slaves that can be connected, you should take into consideration that the maximum number of 96 light rays must not be exceeded.

There are slaves for transmitters and receivers. These may simply be connected to the master light curtain. As many as 2 slaves may be connected respectively to the transmitter and receiver unit.

Installation:

1. The end cap should be screwed off for the light curtain (without cable gland).
2. The plug-in jumper on the connectors of the printed circuit board, which is now visible, should be removed.
3. The slave is designed so that the cap located on the cable connector can be plugged directly onto the open end of the light curtain with the printed circuit board.
4. After you have screwed on the connection cap, the system is complete.

## System accessories

- Mounting set SLC
- Test rods SLC14/SLC30/SLC60
- Protective glass pieces for SLC (to protect the optically functional surface)
- Lateral screwed connection SLC
- Profile alignment aid
- Laser alignment aid SLC
- Mirror for SLC (for securing hazardous areas on multiple sides)
- Ground pillar UC SLP/SLC
- Housing for pillar  
Enclosure UC SLP/SLC
- Collision protector  
Damping UC SLP/SLC