

# Safety light curtain

## SLC14-1350/129/130/151



- Sensing range up to 5 m
- Resolution 14 mm (finger protection)
- Self-monitoring (type 4 according to IEC/EN 61496-1)
- Master/Slave detection, Plug and Play
- Very short response time
- Degree of protection IP67
- Integrated function display
- Pre-fault indication
- Connection via appliance socket M12 x b1
- Safety outputs OSSD in potential-separated semiconductor version
- Protective field height up to 1800 mm
- Start/Restart disable preset by Option /129



### Dimensions

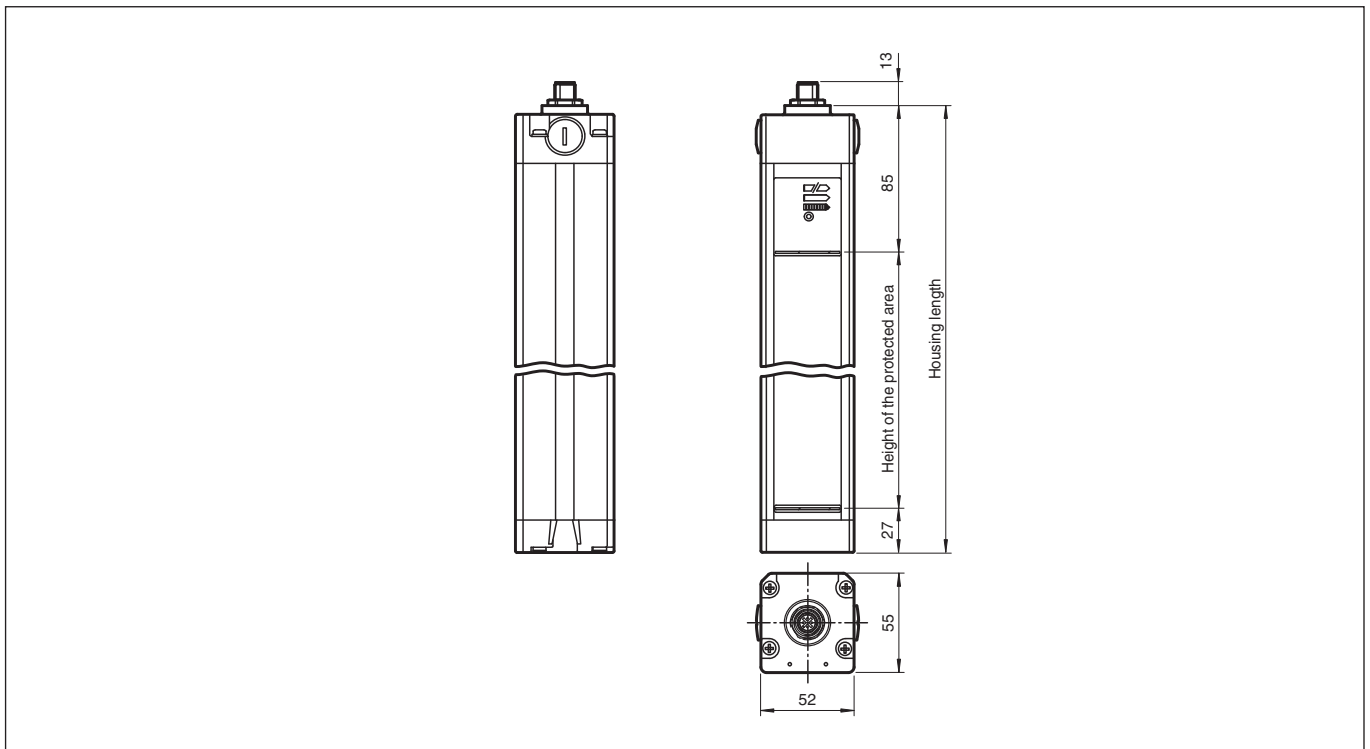

### Technical Data

System components	
Emitter	SLC14-1350-T/130
Receiver	SLC14-1350-R/129/130/151
General specifications	
Effective detection range	0.2 ... 5 m
Light source	IRED
Light type	modulated infrared light
LED risk group labelling	exempt group

Release date: 2020-03-23 Date of issue: 2020-10-06 Filename: 199736\_eng.pdf

Refer to "General Notes Relating to Pepperl+Fuchs Product Information".

Pepperl+Fuchs Group  
www.pepperl-fuchs.com

USA: +1 330 486 0001  
fa-info@us.pepperl-fuchs.com

Germany: +49 621 776 1111  
fa-info@de.pepperl-fuchs.com

Singapore: +65 6779 9091  
fa-info@sg.pepperl-fuchs.com

**pf** PEPPERL+FUCHS

## Technical Data

Tests		IEC/EN 61496
Safety type according to IEC/EN 61496		4
Width of protected area		0.2 ... 5 m
Protection field height		1350 mm
Number of beams		144
Operating mode		can be selected with or without start/restart disable
Optical resolution		14 mm
Angle of divergence		< 5 °
<b>Functional safety related parameters</b>		
Safety Integrity Level (SIL)		SIL 3
Performance level (PL)		PL e
Category		Cat. 4
Mission Time (T <sub>M</sub> )		20 a
PFH <sub>d</sub>		2.42 E-8
Type		4
<b>Indicators/operating means</b>		
Operation indicator		7-segment display in emitter
Diagnostics indicator		7-segment display in receiver
Function indicator		in receiver: LED red: OSSD off LED green: OSSD on LED yellow: Protected area free, system start-ready
Pre-fault indicator		LED orange
Control elements		switch for start/restart disable, transmission coding
<b>Electrical specifications</b>		
Operating voltage	U <sub>B</sub>	24 V DC (-30 %/+25 %)
No-load supply current	I <sub>0</sub>	Emitter: ≤ 100 mA receiver: ≤ 150 mA
Protection class		III
<b>Input</b>		
Activation current		approx. 10 mA
Activation time		0.03 ... 1 s
Test input		Reset-input for system test (not for option /129)
Function input		Start release
<b>Output</b>		
Safety output		2 separated fail safe semiconductor outputs
Signal output		1 PNP, max. 100 mA for start readiness
Switching voltage		Operating voltage -2 V
Switching current		max. 0.5 A
Response time		28 ms
<b>Conformity</b>		
Functional safety		ISO 13849-1
Product standard		EN 61496-1 ; IEC 61496-2
<b>Approvals and certificates</b>		
CE conformity		CE
UL approval		cULus Listed
CCC approval		CCC approval / marking not required for products rated ≤36 V
TÜV approval		TÜV
<b>Ambient conditions</b>		
Ambient temperature		0 ... 55 °C (32 ... 131 °F)
Storage temperature		-25 ... 70 °C (-13 ... 158 °F)
Relative humidity		max. 95 %, not condensing
<b>Mechanical specifications</b>		
Housing length L		1460 mm
Degree of protection		IP67

Release date: 2020-03-23 Date of issue: 2020-10-06 Filename: 199736\_eng.pdf

### Technical Data

Connection	Emitter: M12 connector, 4-pin Receiver: M12 connector, 8-pin
Material	
Housing	extruded aluminum profile, RAL 1021 (yellow) coated
Optical face	Plastic pane
Mass	Per 4350 g

### Connection Assignment

Emitter

Receiver

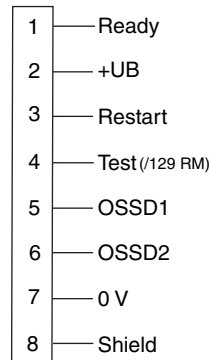
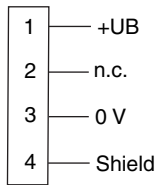

### Connection Assignment

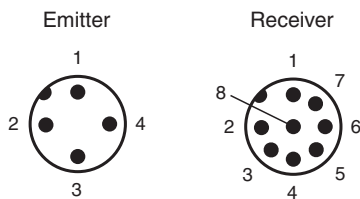

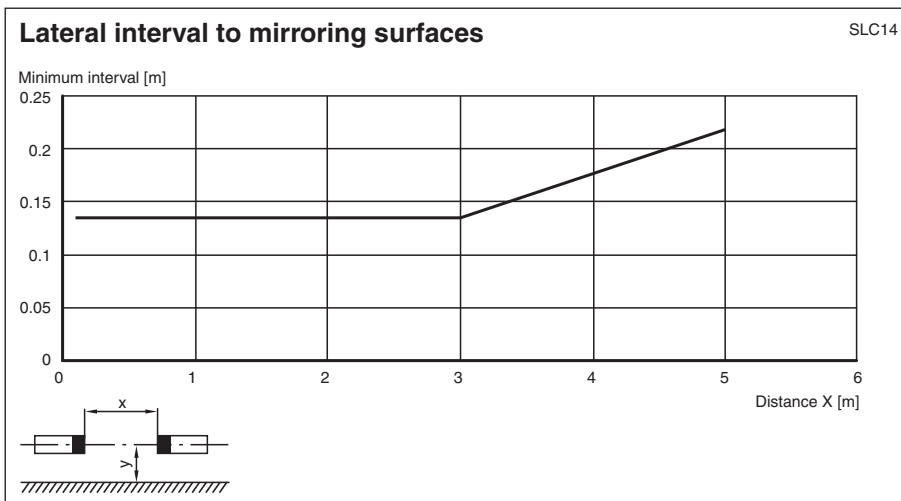
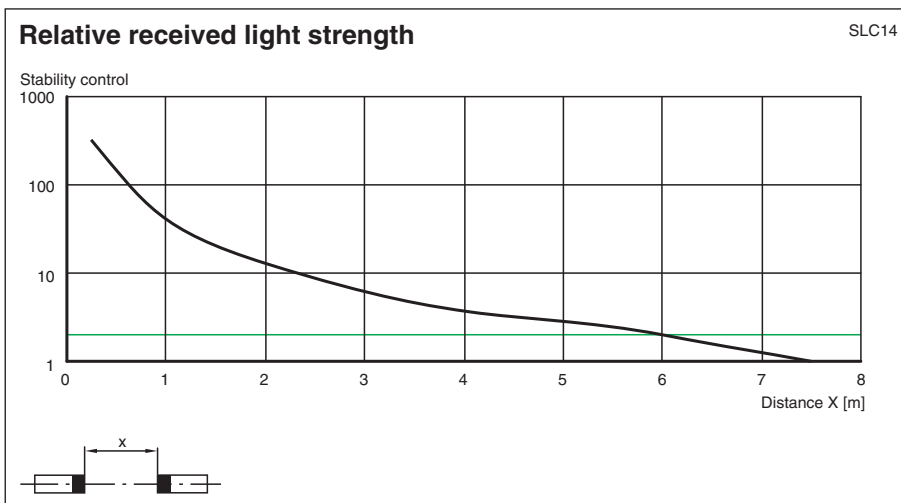
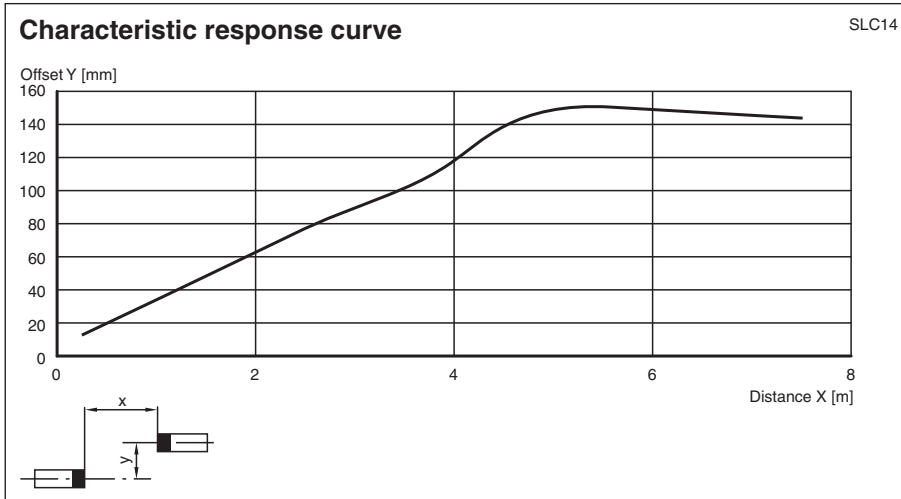

Release date: 2020-03-23 Date of issue: 2020-10-06 Filename: 199736\_eng.pdf

## Characteristic Curve















## Matching system components

	<b>SB4-OR-4XP-B-4159</b>	Safety control unit
	<b>SB4-OR-4XP</b>	Safety control unit
	<b>SB4-OR-4XP-B</b>	SB4 series safety control unit with 1 optional module slot for functional enhancement

Release date: 2020-03-23 Date of issue: 2020-10-06 Filename: 199736\_eng.pdf

### Matching system components

	<b>SB4-OR-4XP-B-B</b>	SB4 series safety control unit with optional module slots for functional enhancement
	<b>SB4-OR-4XP-B-B-B</b>	SB4 series safety control unit with optional module slots for functional enhancement
	<b>SB4-OR-4XP-B-B-B-B</b>	SB4 series safety control unit with optional module slots for functional enhancement
	<b>SB4-OR-4XP-B-B-B-B-B</b>	SB4 series safety control unit with optional module slots for functional enhancement
	<b>SB4-OR-4XP-B-4158</b>	Safety control unit
	<b>SB4-OR-4XP-3819</b>	Safety control unit
	<b>SB4-OR-4XP-4M</b>	Safety control unit
	<b>SB4-OR-4XP-4MD</b>	Safety control unit
	<b>SB4-OR-4XP-4M-4136</b>	Safety control unit of series SB4
	<b>SB4-OR-4XP-4X</b>	Safety control unit
	<b>SB4-OR-4XP-4X-3819</b>	Safety control unit
	<b>SB4-OR-4XP-4136</b>	Safety control unit of series SB4

### Accessories

	<b>PG SLC-1350</b>	Protective glass panes for SLC series
---	--------------------	---------------------------------------

Release date: 2020-03-23 Date of issue: 2020-10-06 Filename: 199736\_eng.pdf

## Note

### Master-Slave operation

Master: SLC...-... (semiconductor)  
or SLC...-.../31 (relay)

Slave: SLC...-...-S

The use of slaves allows both the protection fields to be extended and protection fields to be created that do not all exist at a single level. When deciding which slaves to connect, remember that the total maximum of 96 beams must not be exceeded. Up to 192 beams are possible if the /130 option is selected.

Slaves exist for the transmitter and the receiver. These simply need to be connected to the master light curtain. Up to two slaves can be connected to both the transmitter and receiving units. Only one slave can be connected if the /130 option is selected.

Installation:

1. The end cap (no cable gland) on the light curtain is unscrewed and removed.
2. The plug-in jumper on the connectors of the now visible PCB is removed.
3. The slave is designed in such a way that the cap and PCB on the connecting cable plug directly onto the open end of the light curtain.
4. Once the end cap has been screwed on, the system is complete.

## System accessories

- Mounting set SLC
- Test rods SLC14/SLC30/SLC60
- Protection glass for SLC (to protect the optical surface)
- Side cable gland SLC
- Profile alignment tool
- Beam alignment tool SLC
- Mirror for SLC (to protect danger areas on more than one side)
- Stands UC SLP/SLC
- Enclosure for stands  
Enclosure UC SLP/SLC
- Start protection  
Damping UC SLP/SLC