

# WIS transmitter secondary

## NDS5-30GM-1M-V1

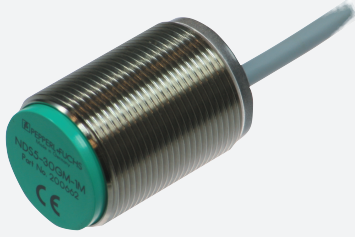

- Transfer range up to 5 mm
- Short version
- Connection via V1 (M12 x 1) plug connection

Inductive transmitter system



### Dimensions

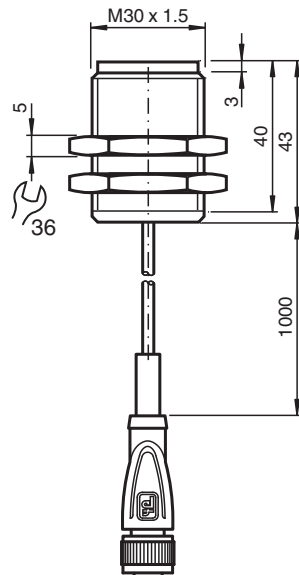

### Technical Data

General specifications	
Installation	non-flush
Transfer distance	0 ... 5 mm
Output type	2-wire
Functional safety related parameters	
MTTF <sub>d</sub>	37485 a
Mission Time (T <sub>M</sub> )	20 a
Diagnostic Coverage (DC)	0 %
Approvals and certificates	
CCC approval	CCC approval / marking not required for products rated ≤36 V
Ambient conditions	
Ambient temperature	0 ... 50 °C (32 ... 122 °F)

Release date: 2022-06-21 | Date of issue: 2022-06-21 | Filename: 200662\_eng.pdf

Refer to "General Notes Relating to Pepperl+Fuchs Product Information".

Pepperl+Fuchs Group  
www.pepperl-fuchs.com

USA: +1 330 486 0001  
fa-info@us.pepperl-fuchs.com

Germany: +49 621 776 1111  
fa-info@de.pepperl-fuchs.com

Singapore: +65 6779 9091  
fa-info@sg.pepperl-fuchs.com

PEPPERL+FUCHS

## Technical Data

Storage temperature	-25 ... 85 °C (-13 ... 185 °F)	
<b>Mechanical specifications</b>		
Housing material	brass, nickel-plated	
Sensing face	PBT	
Degree of protection	IP67	
Installation	screw mounting	
Free zone	A	≥ 3 mm
Spacing to metal walls	B	≥ Ø 50 mm
Security zone	W x H	≥ 60 mm x 15 mm
<b>General information</b>		
Note	Maximum cable length between WIS module and WIS transmitter must not exceed 5 m.	

## Characteristic Curve

### Transfer distance

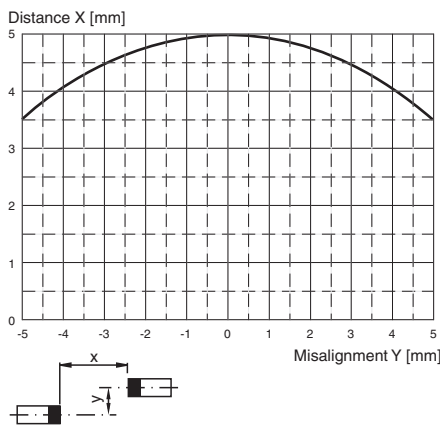

### Transferable power

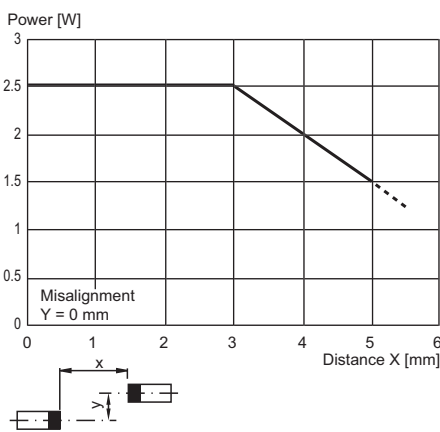

Release date: 2022-06-21 Date of issue: 2022-06-21 Filename: 200662\_eng.pdf

## Accessories

	<b>BF 30</b>	Mounting flange, 30 mm
---	--------------	------------------------

**Function**

**Functional description**

A WIS (wireless inductive system) inductive transfer system always consists of the following four components:

- WIS primary module
- WIS primary transmitter
- WIS secondary transmitter
- WIS secondary module

The WIS primary module is installed in the stationary component and is connected to a downstream control (i.e., PLC). The WIS primary transmitter connected to the WIS primary module. The WIS secondary transmitter and the WIS secondary module that is connected to it are installed in the moveable part of the component. The WIS secondary module disposes of connection capabilities for several sensors. If the two transmitters are located in front of each other within the system range, then electric power is transferred from the primary side to the secondary side. The sensors attached to the WIS secondary module are now supplied with electric energy and begin to operate. The sensor output signals are transmitted in the opposite direction from the secondary side to the primary side and are separately available on the WIS primary module output terminals for further processing by the equipment control. The sensor signal status is also displayed by LEDs that correspond to the sensor channels. A separate output signal Tx on the WIS primary module indicates the communication status. A high signal indicates communication between the WIS transmitters. This is also indicated by a glowing LED Tx.

Power transfer and communication in the system can be activated and deactivated on the WIS primary module with the EN input .

Input signal on EN	Function
+ UB (24 V DC)	Transfer activated
GND or open.	Transfer deactivated

**Function schematic**

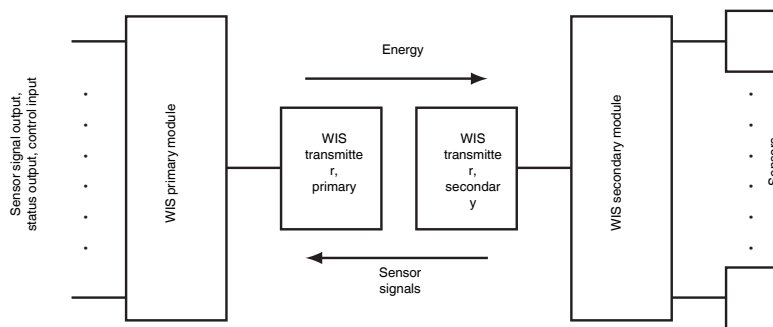

The sum of the currents of all sensors attached to the WIS secondary module must not be greater than the maximum transferable current. This is calculated by dividing the transferable power by the 12 V provided by the transmitters.

**Installation requirements**

During operation, the WIS transmitter heats up due to the transfer of electrical energy for the sensor supply from the primary side of the transfer system to the secondary side, primarily by about 40 K above the ambient temperature. By installing the WIS transmitter in metal mounting components heat dissipation can be improved.

If a number of systems are to be installed the cable routing must be isolated.

Care must be taken in terms of the minimum separation from metal parts when installing the WIS transmitter. Because of the inductive operating principal employed surrounding metal parts can heat up due to the induction of eddy currents.

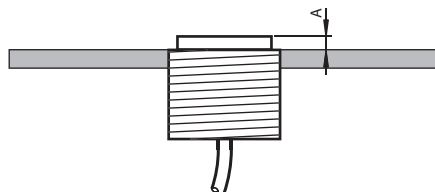

Minimum 'free zone' requirements of the WIS transmitters when installed in metal

Release date: 2022-06-21 Date of issue: 2022-06-21 Filename: 200662\_eng.pdf

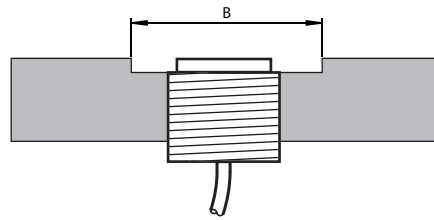

In order to avoid changes in the transfer characteristics, care must be taken to ensure that the specified separation from metal walls (which exceeds the minimum free zone) is always maintained on both WIS transmitters.

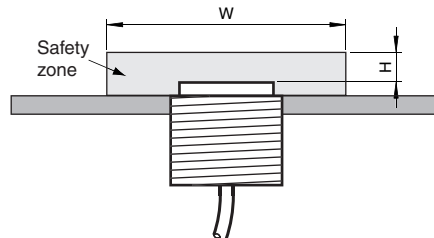

Metal objects must not be inserted or handled in the area of the safety zone during operation.

In the event that this cannot be avoided, the transfer must be deactivated with the enable input, EN, on the front of the primary module.

Please refer to the technical data for installation dimensions.