

# Through-beam ultrasonic barrier

## UBE1000-18GM40-SE2-V1



- Short design, 40 mm
- Function indicators visible from all directions
- Switching output
- Program input
- Integrated alignment aid

Single head system



### Dimensions

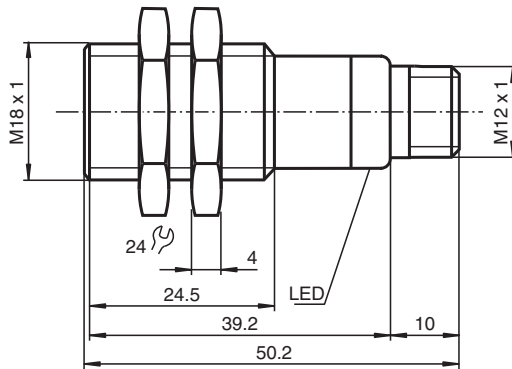

### Technical Data

#### General specifications

Sensing range	15 ... 1000 mm
Standard target plate	100 mm x 100 mm
Transducer frequency	approx. 255 kHz

#### Indicators/operating means

LED green	Power on
LED yellow	switching state
LED red	error, object uncertain

#### Electrical specifications

Operating voltage	$U_B$	10 ... 30 V DC , ripple 10 % <sub>SS</sub>
-------------------	-------	--

Release date: 2022-08-02 Date of issue: 2022-08-02 Filename: 205346\_eng.pdf

Refer to "General Notes Relating to Pepperl+Fuchs Product Information".

Pepperl+Fuchs Group  
www.pepperl-fuchs.com

USA: +1 330 486 0001  
fa-info@us.pepperl-fuchs.com

Germany: +49 621 776 1111  
fa-info@de.pepperl-fuchs.com

Singapore: +65 6779 9091  
fa-info@sg.pepperl-fuchs.com

**pf** PEPPERL+FUCHS

## Technical Data

No-load supply current	$I_0$	$\leq 20$ mA
Time delay before availability	$t_v$	$\leq 200$ ms
<b>Input</b>		
Input type	1 program input free air path: $-U_B \dots +1$ V, object: $+6$ V $\dots +U_B$ input impedance: $> 4,7$ k $\Omega$ program pulse: $\geq 1$ s	
<b>Output</b>		
Output type	PNP, NO	
Rated operating current	$I_e$	200 mA , short-circuit/overload protected
Voltage drop	$U_d$	$\leq 3$ V
Switch-on delay	$t_{on}$	$< 5$ ms
Switching frequency	$f$	$\leq 100$ Hz
<b>Compliance with standards and directives</b>		
Standard conformity		
Standards	EN IEC 60947-5-2:2020 IEC 60947-5-2:2019	
<b>Approvals and certificates</b>		
EAC conformity	TR CU 020/2011 TR CU 037/2016	
UL approval	cULus Listed, Class 2 Power Source	
CCC approval	CCC approval / marking not required for products rated $\leq 36$ V	
<b>Ambient conditions</b>		
Ambient temperature	$-25 \dots 70$ °C ( $-13 \dots 158$ °F)	
Storage temperature	$-40 \dots 85$ °C ( $-40 \dots 185$ °F)	
<b>Mechanical specifications</b>		
Connection type	Connector plug M12 x 1 , 4-pin	
Housing diameter	18 mm	
Degree of protection	IP67	
Material		
Housing	brass, nickel-plated	
Transducer	epoxy resin/hollow glass sphere mixture; foam polyurethane, cover PBT	
Mass	25 g	

## Connection

### Standard symbol/Connection:

(version E2, pnp)

Receiver:

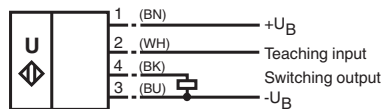

Emitter:

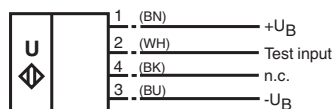

Core colours in accordance with EN 60947-5-2.

## Connection Assignment



Wire colors in accordance with EN 60947-5-2

1	BN	(brown)
2	WH	(white)
3	BU	(blue)
4	BK	(black)

## Characteristic Curve

### Characteristic response curve

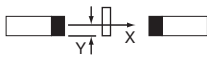
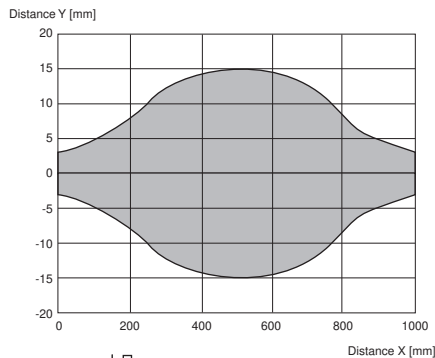

Obstacle: flat plate 100 mm x 100 mm

### Obstacle size

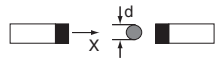
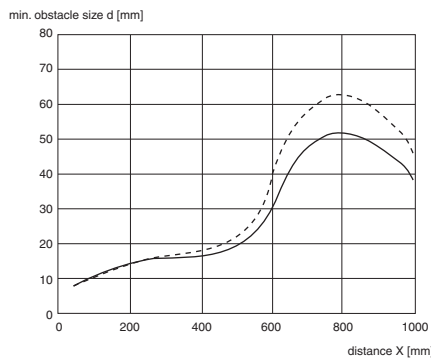







— with Teach-In  
 - - - without Teach-In

## Accessories

	<b>UB-PROG2</b>	Programming unit
	<b>OMH-04</b>	Mounting aid for round steel $\varnothing$ 12 mm or sheet 1.5 mm ... 3 mm

Release date: 2022-08-02 Date of issue: 2022-08-02 Filename: 205346\_eng.pdf

## Accessories

	<b>BF 18</b>	Mounting flange, 18 mm
	<b>BF 18-F</b>	Plastic mounting adapter, 18 mm
	<b>BF 5-30</b>	Universal mounting bracket for cylindrical sensors with a diameter of 5 ... 30 mm
	<b>V1-G-2M-PVC</b>	Female cordset single-ended M12 straight A-coded, 4-pin, PVC cable grey
	<b>V1-W-2M-PUR</b>	Female cordset single-ended M12 angled A-coded, 4-pin, PUR cable grey
	<b>UVW90-K18</b>	Ultrasonic -deflector
	<b>M18K-VE</b>	Plastic nuts with centering ring for the vibration-free mounting of cylindrical sensors

## Additional Information

### Function

A through-beam ultrasonic barrier always consists of a single emitter and a single receiver. The function of a through-beam ultrasonic barrier is based in the interruption of the sound transmission to the receiver by the object to be detected.

The emitter sends an ultrasonic signal that is evaluated by the receiver. If the signal is interrupted or muted by the object to be detected, the receiver switches.

No electrical connections are required between the emitter and receiver.

The function of through-beam ultrasonic barriers is not dependent on the position of their installation. We recommend, however, to install the emitter below in the case of vertical installations to prevent the accumulation of dust particles.

### Startup and parameterising

For easy alignment of emitter and receiver towards each other, the receiver is equipped with an alignment aid. To activate the alignment aid, the TEACH-Input of the receiver (pin 2) has to be connected to ground (-U<sub>B</sub>). The flashing frequency of the yellow LED indicates the strength of the received ultrasonic signal. The better the alignment, the stronger the signal.

LED yellow, flashing frequency	Description
slowly (appr. 1.5 Hz)	no signal
medium (appr. 3 Hz)	weak signal
fast (appr. 9 Hz)	strong signal

Simultaneously the ultrasonic barrier evaluates the signal strength of the unobstructed signal path and generates the optimal switching threshold. When disconnecting the TEACH-input from -U<sub>B</sub>, this threshold is stored non-volatile in the receivers memory. In case of clear ultrasonic path (no object), only the receivers green LED is on.

### TEACH-In of very small objects/obstacles

Like shown in the curve "obstacle size", the ultrasonic barrier offers the possibility to detect very small objects at a distance of more than 300 mm.

- place the object to be detected in the desired distance inside the ultrasonic path
- connect TEACH-input of the receiver to +U<sub>B</sub> (yellow LED flashes slowly)
- disconnect TEACH-input

In case of successful TEACH-IN (object is detected reliable), the yellow LED is on and the taught detection threshold is stored non-volatile to the receivers memory.

In case of unsuccessful TEACH-IN (object too small or too porous for ultrasonic sound), the red LED flashes 5 times and the ultrasonic barrier continues normal operation with unmodified detection threshold value.

### Test function

For test purpose, the ultrasonic emitter is equipped with a test input. In normal operation mode (test input not connected or connected to -U<sub>B</sub>), the green LED of the emitter is on. If the test input is connected to +U<sub>B</sub>, the ultrasonic emitter gets deactivated and its LED changes into red. Simultaneously the receiver switches and its yellow LED goes on.