

Through-beam ultrasonic barrier

UBE1000-18GM40A-SE2-V1-Y205349



- Short design, 40 mm
- Function indicators visible from all directions
- Switching output
- Program input
- 58 mm pre-taught sensor spacing

Single head system



Dimensions

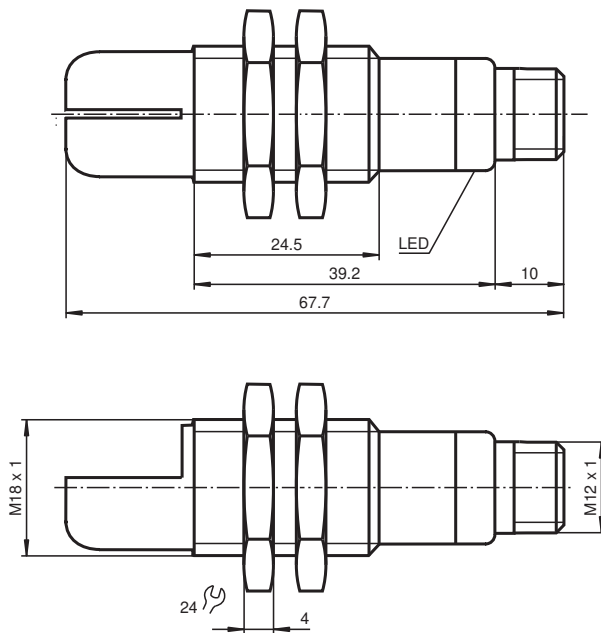

Technical Data

General specifications

| | |
|-----------------------|-----------------|
| Sensing range | 15 ... 1000 mm |
| Standard target plate | 100 mm x 100 mm |
| Transducer frequency | approx. 255 kHz |

Indicators/operating means

| | |
|------------|-------------------------|
| LED green | Power on |
| LED yellow | switching state |
| LED red | error, object uncertain |

Electrical specifications

| | | |
|-------------------|-------|--|
| Operating voltage | U_B | 10 ... 30 V DC , ripple 10 % _{SS} |
|-------------------|-------|--|

Release date: 2022-08-02 Date of issue: 2022-08-03 Filename: 205349_eng.pdf

Refer to "General Notes Relating to Pepperl+Fuchs Product Information".

Pepperl+Fuchs Group
www.pepperl-fuchs.com

USA: +1 330 486 0001
fa-info@us.pepperl-fuchs.com

Germany: +49 621 776 1111
fa-info@de.pepperl-fuchs.com

Singapore: +65 6779 9091
fa-info@sg.pepperl-fuchs.com

 PEPPERL+FUCHS

Technical Data

| | | |
|---|----------|---|
| No-load supply current | I_0 | $\leq 20 \text{ mA}$ |
| Input | | |
| Input type | | 1 program input free air path: $-U_B \dots +1 \text{ V}$, object: $+6 \text{ V} \dots +U_B$ input impedance: $> 4,7 \text{ k}\Omega$ program pulse: $\geq 1 \text{ s}$ |
| Output | | |
| Output type | | PNP, NO |
| Rated operating current | I_e | 200 mA , short-circuit/overload protected |
| Default setting | | emitter/receiver spacing = 58 mm |
| Voltage drop | U_d | $\leq 3 \text{ V}$ |
| Switch-on delay | t_{on} | $< 5 \text{ ms}$ |
| Switching frequency | f | $\leq 100 \text{ Hz}$ |
| Compliance with standards and directives | | |
| Standard conformity | | |
| Standards | | EN IEC 60947-5-2:2020 IEC 60947-5-2:2019 |
| Approvals and certificates | | |
| EAC conformity | | TR CU 020/2011 TR CU 037/2016 |
| UL approval | | cULus Listed, Class 2 Power Source |
| CCC approval | | CCC approval / marking not required for products rated $\leq 36 \text{ V}$ |
| Ambient conditions | | |
| Ambient temperature | | $-25 \dots 70 \text{ }^\circ\text{C}$ ($-13 \dots 158 \text{ }^\circ\text{F}$) |
| Storage temperature | | $-40 \dots 85 \text{ }^\circ\text{C}$ ($-40 \dots 185 \text{ }^\circ\text{F}$) |
| Mechanical specifications | | |
| Connection type | | Connector plug M12 x 1 , 4-pin |
| Housing diameter | | 18 mm |
| Degree of protection | | IP67 |
| Connection | | V1 connector (M12 x 1), 4-pin |
| Material | | |
| Housing | | brass, nickel-plated |
| Transducer | | epoxy resin/hollow glass sphere mixture; foam polyurethane, cover PBT |
| Mass | | 25 g |

Connection

Standard symbol/Connection:
(version E2, pnp)

Receiver:

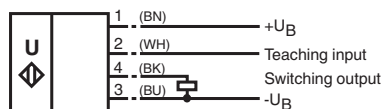

Emitter:

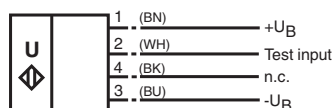

Core colours in accordance with EN 60947-5-2.

Connection Assignment

Connector V1



Characteristic Curve

Characteristic response curve

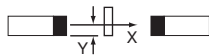
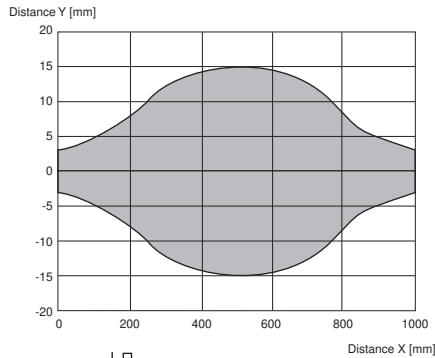

Obstacle: flat plate 100 mm x 100 mm

Obstacle size

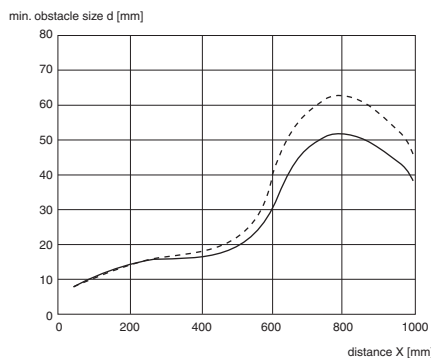



Accessories

| | | |
|--|--------------------|---|
| | UB-PROG2 | Programming unit |
| | OMH-04 | Mounting aid for round steel \varnothing 12 mm or sheet 1.5 mm ... 3 mm |
| | BF 18 | Mounting flange, 18 mm |
| | BF 18-F | Plastic mounting adapter, 18 mm |
| | BF 5-30 | Universal mounting bracket for cylindrical sensors with a diameter of 5 ... 30 mm |
| | V1-G-2M-PVC | Female cordset single-ended M12 straight A-coded, 4-pin, PVC cable grey |

Release date: 2022-08-02 Date of issue: 2022-08-03 Filename: 205349_eng.pdf

Accessories

| | | |
|---|--------------------|---|
|  | V1-W-2M-PUR | Female cordset single-ended M12 angled A-coded, 4-pin, PUR cable grey |
|  | UVW90-K18 | Ultrasonic -deflector |
|  | M18K-VE | Plastic nuts with centering ring for the vibration-free mounting of cylindrical sensors |

Additional Information

Function

A through-beam ultrasonic barrier always consists of a single emitter and a single receiver. The function of a through-beam ultrasonic barrier is based in the interruption of the sound transmission to the receiver by the object to be detected.

The emitter sends an ultrasonic signal that is evaluated by the receiver. If the signal is interrupted or muted by the object to be detected, the receiver switches.

No electrical connections are required between the emitter and receiver.

The function of through-beam ultrasonic barriers is not dependent on the position of their installation. We recommend, however, to install the emitter below in the case of vertical installations to prevent the accumulation of dust particles.

Startup and parameterising

For easy alignment of emitter and receiver towards each other, the receiver is equipped with an alignment aid. To activate the alignment aid, the TEACH-Input of the receiver (pin 2) has to be connected to ground (-U_B). The flashing frequency of the yellow LED indicates the strength of the received ultrasonic signal. The better the alignment, the stronger the signal.

| LED yellow, flashing frequency | Description |
|--------------------------------|---------------|
| slowly (appr. 1.5 Hz) | no signal |
| medium (appr. 3 Hz) | weak signal |
| fast (appr. 9 Hz) | strong signal |

Simultaneously the ultrasonic barrier evaluates the signal strength of the unobstructed signal path and generates the optimal switching threshold. When disconnecting the TEACH-input from -U_B, this threshold is stored non-volatile in the receivers memory. In case of clear ultrasonic path (no object), only the receivers green LED is on.

TEACH-In of very small objects/obstacles

Like shown in the curve "obstacle size", the ultrasonic barrier offers the possibility to detect very small objects at a distance of more than 300 mm.

- place the object to be detected in the desired distance inside the ultrasonic path
- connect TEACH-input of the receiver to +U_B (yellow LED flashes slowly)
- disconnect TEACH-input

In case of successful TEACH-IN (object is detected reliable), the yellow LED is on and the taught detection threshold is stored non-volatile to the receivers memory.

In case of unsuccessful TEACH-IN (object too small or too porous for ultrasonic sound), the red LED flashes 5 times and the ultrasonic barrier continues normal operation with unmodified detection threshold value.

Test function

For test purpose, the ultrasonic emitter is equipped with a test input. In normal operation mode (test input not connected or connected to -U_B), the green LED of the emitter is on. If the test input is connected to +U_B, the ultrasonic emitter gets deactivated and its LED changes into red. Simultaneously the receiver switches and its yellow LED goes on.