



# AS-Interface Gateway/Safety Monitor

## VBG-PB-K30-DMD-S16

- Gateway and safety monitor in one housing
- Gateway compliant with AS-Interface specification 3.0
- Connection to PROFIBUS DP
- AS-Interface safety monitor with extended range of functions
- Certified up to SIL 3 according to IEC 61508 and EN 62061 and up to PL<sub>e</sub> according to EN 13849
- Memory card for configuration data
- 2 AS-Interface networks
- 2 safe output relays and 2 safe electronic outputs

Gateway with integrated Safety Monitor



### Function

The VBG-PB-K30-DMD-S16\* is an IP20-rated PROFIBUS gateway with an integral safety monitor and a double master according to AS-Interface specification 3.0. The VBG-PB-K30-DMD-S16 has four inputs and four outputs. The four inputs are used either for extended EDM device monitoring or as start inputs. Two sets of two outputs act as relay outputs and switch output circuits 1 and 2 and, as semiconductor outputs, output circuits 3 and 4. The K30 model is particularly suitable for installation in a control cabinet.

The VBG-PB-K30-DMD-S16\* is a combined full-specification AS-Interface PROFIBUS gateway and safety monitor. The product allows a gateway and a safety monitor to be used in a single device.

Two safety relays provide a safe interface to the connected consumers. The AS-Interface 3.0 PROFIBUS gateways are used to connect AS-I systems to a higher-level PROFIBUS. They act as a double master for the AS-I segment and as a slave for the PROFIBUS.

The AS-I functions are made available on both a cyclic and acyclic basis through PROFIBUS-DP V1. During cyclic data exchange, up to 32 bytes of I/O data (this amount is variable) are transferred as the digital data of an AS-I segment. In addition, analog values as well as the complete command set of the new AS-I specification can be transferred via PROFIBUS using a command interface. Monitoring of the AS-Interface data can be carried out online via PROFIBUS-DP V1 using the serial PROFIBUS master and the AS-I Control Tools.

Address assignment, the transfer of the desired configuration and the setting of the Profibus address and baud rate can all be performed using switches. Seven LEDs located on the front panel indicate the current status of the AS-Interface segment. One LED shows the power supply via AUX. A further eight LEDs indicate the status of the inputs and outputs. If the AS-Interface gateway has a graphical display, the commissioning of the AS-Interface circuit and testing of the connected peripherals can take place completely separately from the commissioning of PROFIBUS and the programming. Local operation using the graphical display and the four switches allows all the functions covered on the other AS-Interface masters by AS-i Control Tools software to be visualized on the display. An additional RS-232 socket provides a way of exporting data relating to the gateway, network and operation directly from the gateway for extended local diagnosis purposes.

### Dimensions

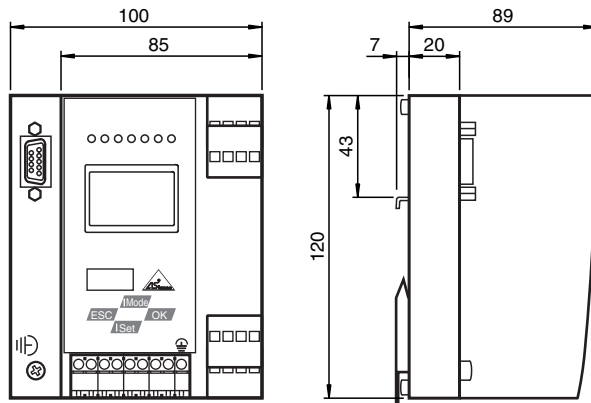

### Technical Data

#### General specifications

AS-Interface specification	V3.0
PLC-Functionality	activateable

Release date: 2021-09-27 Date of issue: 2021-09-27 Filename: 207741\_eng.pdf

Refer to "General Notes Relating to Pepperl+Fuchs Product Information".

Pepperl+Fuchs Group  
www.pepperl-fuchs.com

USA: +1 330 486 0001  
fa-info@us.pepperl-fuchs.com

Germany: +49 621 776 1111  
fa-info@de.pepperl-fuchs.com

Singapore: +65 6779 9091  
fa-info@sg.pepperl-fuchs.com

**PF** PEPPERL+FUCHS

## Technical Data

Duplicate address detection		from AS-Interface slaves
Earth fault detection	EFD	integrated
EMC monitoring		integrated
Diagnostics function		Extended function via display
Switch-on delay		< 10 s
Response delay		< 40 ms
UL File Number		E223772 only from low voltage, limited energy source (SELV or PELV) or listed Class 2 source
<b>Functional safety related parameters</b>		
Safety Integrity Level (SIL)		SIL 3
Performance level (PL)		PL e
MTTF <sub>d</sub>		200 a
B <sub>10d</sub>		2 E+7
<b>Indicators/operating means</b>		
Display		Illuminated graphical LC display for addressing and error messages
LED PROFIBUS		PROFIBUS master detected; LED green
LED AS-i ACTIVE		AS-Interface operation normal; LED green
LED CONFIG ERR		configuration error; LED red
LED PRG ENABLE		autom. programming; LED green
LED POWER		voltage ON; LED green
LED PRJ MODE		projecting mode active; LED yellow
LED U AS-i		AS-Interface voltage; LED green
LED AUX		ext. auxiliary voltage U <sub>AUX</sub> ; LED green
LED EDM/Start		External device monitoring circuit inputs closed, 4x yellow LEDs
LED output circuit		Output circuit closed; 4 x green LEDs
Button		4
<b>Electrical specifications</b>		
Insulation voltage	U <sub>i</sub>	≥ 500 V
Rated operating voltage	U <sub>e</sub>	26.5 ... 31.6 V from AS-Interface; Output K3 and K4 24 V <sub>DC</sub>
Rated operating current	I <sub>e</sub>	≤ 300 mA off AS interface network 1 ≤ 70 mA off AS interface network 2
<b>Interface 1</b>		
Interface type		RS-485
Protocol		PROFIBUS DP V1
Transfer rate		9.6 kBit/s / 12 MBit/s , Automatic baud rate detection
<b>Interface 2</b>		
Interface type		RS 232, serial Diagnostic Interface
Transfer rate		19,2 kBit/s
<b>Interface 3</b>		
Interface type		Chip card slot
<b>Input</b>		
Number/Type		4 EDM/Start inputs: EDM: Inputs for the external device monitoring circuits Start: start inputs: Static switching current 4 mA at 24 V, dynamic 30 mA at 24 V (T=100 μs)
<b>Output</b>		
Safety output		Output circuits 1 and 2: 2 potential-free contacts, max. contact load: 3 A <sub>DC-13</sub> at 30 V <sub>DC</sub> , 3 A <sub>AC-15</sub> at 30 V <sub>AC</sub> Output circuits 3 and 4: 2 PNP transistor outputs max. contact load: 0.5 A <sub>DC-13</sub> at 30 V <sub>DC</sub>
<b>Connection</b>		
PROFIBUS		Sub-D interface
AS-Interface		spring terminals, removable

Release date: 2021-09-27 Date of issue: 2021-09-27 Filename: 207741\_eng.pdf

**Technical Data**

<b>Directive conformity</b>	
Electromagnetic compatibility	
Directive 2014/30/EU	EN 62026-2:2013 EN 61000-6-2:2005, EN 61000-6-4:2007
<b>Standard conformity</b>	
Electromagnetic compatibility	EN 61000-6-2:2005, EN 61000-6-4:2007
Degree of protection	EN 60529:2000
Fieldbus standard	PROFIBUS according to DIN 19245 Part 3
AS-Interface	EN 62026-2:2013
Shock resistance	EN 61131-2:2004
Standards	EN 61000-6-2:2005, EN 61000-6-4:2007 EN 954-1:1996 (up to Kategorie 4), IEC 61508:2001 and EN 62061:2005 (up to SIL3) EN 13849:2008 (PL e)
<b>Approvals and certificates</b>	
UL approval	An isolated source with a secondary open circuit voltage of $\leq 30 V_{DC}$ with a 3 A maximum over current protection. Over current protection is not required when a Class 2 source is employed. UL mark does not provide UL certification for any functional safety rating or aspects of the device.
<b>Ambient conditions</b>	
Ambient temperature	0 ... 55 °C (32 ... 131 °F)
Storage temperature	-25 ... 85 °C (-13 ... 185 °F)
<b>Mechanical specifications</b>	
Degree of protection	IP20
Mass	800 g
Construction type	Low profile housing , Stainless steel

**Connection**

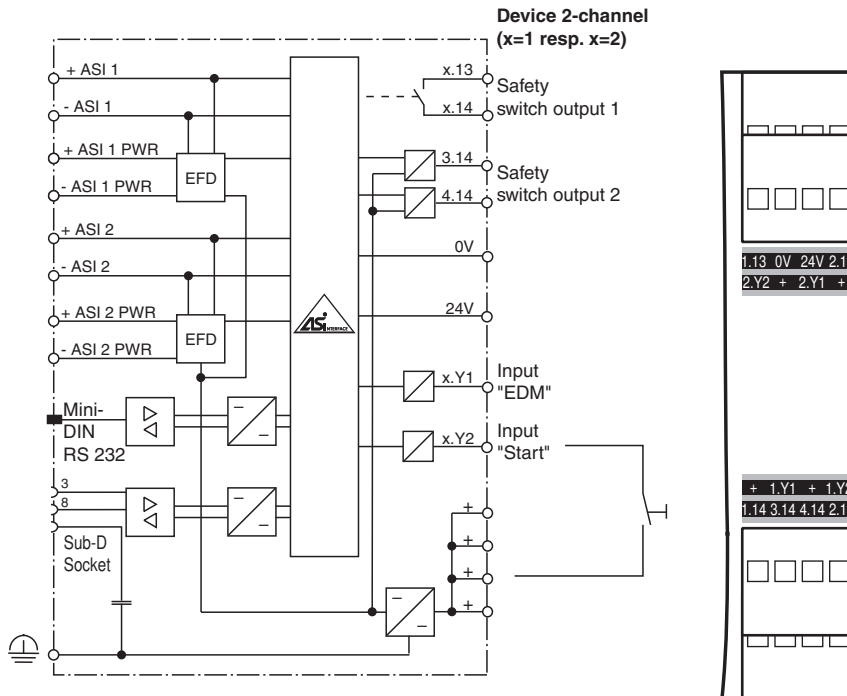

Release date: 2021-09-27 Date of issue: 2021-09-27 Filename: 207741\_eng.pdf



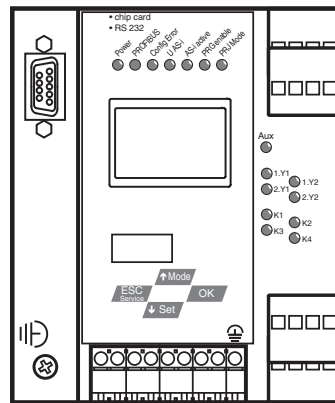

## Assembly



## Connection

In an AS-Interface network only one device can be operated earth fault detection. If there are many devices in an AS-Interface network, this can lead to the earth fault monitoring response threshold becoming less sensitive.

## Accessories

	<b>USB-0,8M-PVC ABG-SUBD9</b>	Interface converter USB/RS 232
	<b>VAZ-PB-DB9-W</b>	PROFIBUS Sub-D Connector with switchable terminal resistance
	<b>VAZ-SW-SIMON+</b>	Software for configuration of K30 Master Monitors/K31 and KE4 Safety Monitors
	<b>VAZ-SIMON+-R2-1,8M-PS/2</b>	Interface cable for connecting the K30/K31 Safety Monitor to a PC