



# Switch Amplifier

## KCD2-ST-2

- 2-channel signal conditioner
- 24 V DC supply (Power Rail)
- Dry contact or NAMUR inputs
- 2 active transistor outputs
- Reversible mode of operation
- Line fault detection (LFD)
- Housing width 12.5 mm
- Up to SIL 2 (SC 3) acc. to IEC/EN 61508

# CE SIL2

## Function

This signal conditioner provides the galvanic isolation between field circuits and control circuits. The device transfers digital signals (NAMUR sensors or dry contacts) from the field to the control system. Each input controls an active transistor output. Via switches the mode of operation can be reversed and the line fault detection can be switched off. A fault is signaled by LEDs acc. to NAMUR NE44 and a separate collective error message output.

## Connection

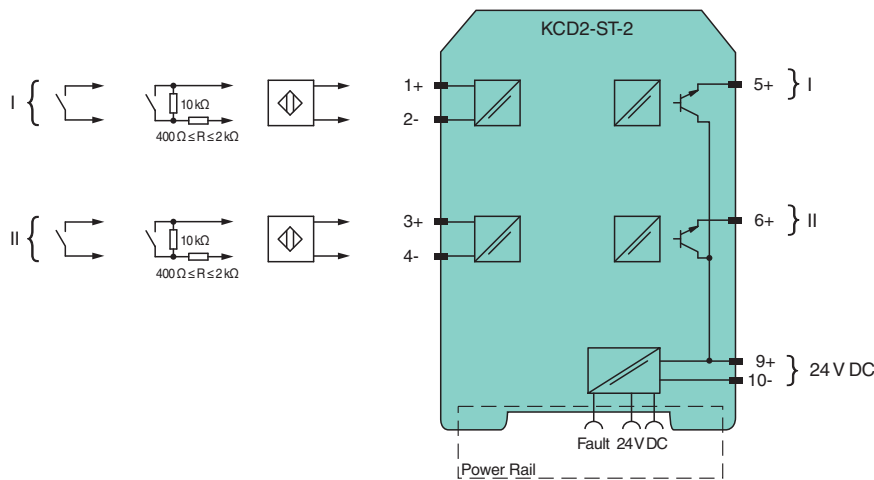

## Technical Data

### General specifications

Signal type Digital Input

### Functional safety related parameters

Safety Integrity Level (SIL) SIL 2  
 Systematic capability (SC) SC 3

### Supply

Connection Power Rail or terminals 9+, 10-  
 Rated voltage  $U_r$  19 ... 30 V DC  
 Ripple  $\leq 10\%$   
 Rated current  $I_r$  30 ... 20 mA +  $I_{out}$   
 Power dissipation  $\leq 800$  mW including maximum power dissipation in the output

Release date: 2023-01-03 Date of issue: 2023-01-03 Filename: 214247\_eng.pdf

Refer to "General Notes Relating to Pepperl+Fuchs Product Information".

Pepperl+Fuchs Group  
 www.pepperl-fuchs.com

USA: +1 330 486 0002  
 pa-info@us.pepperl-fuchs.com

Germany: +49 621 776 2222  
 pa-info@de.pepperl-fuchs.com

Singapore: +65 6779 9091  
 pa-info@sg.pepperl-fuchs.com

**PF** PEPPERL+FUCHS

## Technical Data





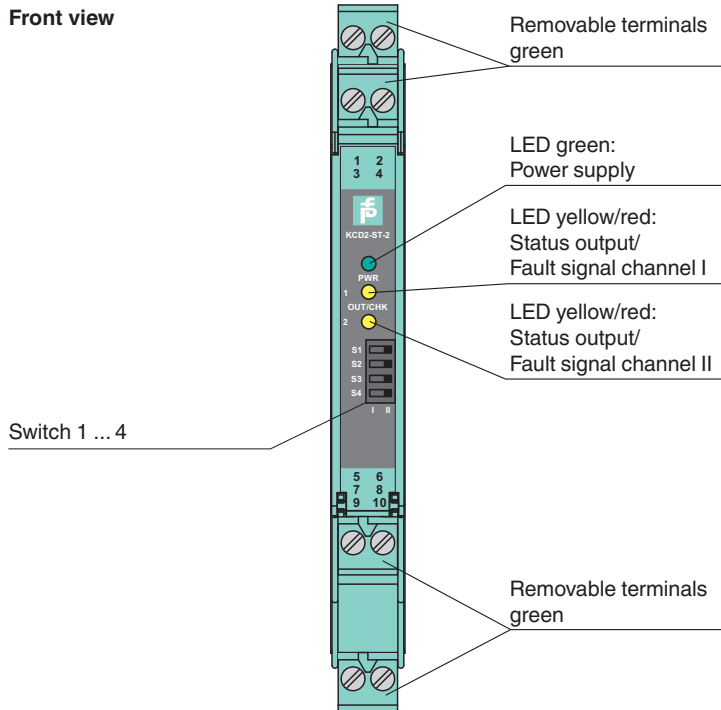

<b>Input</b>		
Connection side		field side
Connection		terminals 1+, 2-; 3+, 4-
Rated values		acc. to EN 60947-5-6 (NAMUR)
Open circuit voltage/short-circuit current		approx. 10 V DC / approx. 8 mA
Switching point/switching hysteresis		1.2 ... 2.1 mA / approx. 0.2 mA
Line fault detection		breakage $I \leq 0.1$ mA , short-circuit $I \geq 6.5$ mA
Pulse/Pause ratio		min. 100 $\mu$ s / min. 100 $\mu$ s
<b>Output</b>		
Connection side		control side
Connection		terminals 5, 6
Rated voltage	$U_r$	30 V DC
Rated current	$I_r$	50 mA
Response time		$\leq 200$ $\mu$ s
Signal level		1-signal: (supply voltage) - 3 V max. for 50 mA 0-signal: blocked output (off-state current $\leq 10$ $\mu$ A)
Output I		signal ; Transistor
Output II		signal ; Transistor
Collective error message		Power Rail
<b>Transfer characteristics</b>		
Switching frequency		$\leq 5$ kHz
<b>Galvanic isolation</b>		
Input/Output		reinforced insulation acc. to EN 50178, rated insulation voltage 300 $V_{eff}$
Input/power supply		reinforced insulation acc. to EN 50178, rated insulation voltage 300 $V_{eff}$
Output/power supply		not available , common pole terminal 9+
Output/Output		not available , common pole terminal 9+
<b>Indicators/settings</b>		
Display elements		LEDs
Control elements		DIP switch
Configuration		via DIP switches
Labeling		space for labeling at the front
<b>Directive conformity</b>		
Electromagnetic compatibility		
Directive 2014/30/EU		EN 61326-1:2013 (industrial locations)
<b>Conformity</b>		
Electromagnetic compatibility		NE 21:2011
Degree of protection		IEC 60529:2001
Protection against electrical shock		IEC 61010-1:2010
Input		EN 60947-5-6:2000
<b>Ambient conditions</b>		
Ambient temperature		-20 ... 60 °C (-4 ... 140 °F) extended ambient temperature range up to 70 °C (158 °F), refer to manual for necessary mounting conditions
<b>Mechanical specifications</b>		
Degree of protection		IP20
Connection		screw terminals
Mass		approx. 100 g
Dimensions		12.5 x 119 x 114 mm (0.5 x 4.7 x 4.5 inch) (W x H x D) , housing type A2
Mounting		on 35 mm DIN mounting rail acc. to EN 60715:2001
<b>General information</b>		
Supplementary information		Observe the certificates, declarations of conformity, instruction manuals, and manuals where applicable. For information see <a href="http://www.pepperl-fuchs.com">www.pepperl-fuchs.com</a> .

## Assembly



Front view



## Matching System Components

	<b>KFD2-EB2</b>	Power Feed Module
	<b>UPR-03</b>	Universal Power Rail with end caps and cover, 3 conductors, length: 2 m
	<b>UPR-03-M</b>	Universal Power Rail with end caps and cover, 3 conductors, length: 1,6 m
	<b>UPR-03-S</b>	Universal Power Rail with end caps and cover, 3 conductors, length: 0.8 m
	<b>K-DUCT-GY</b>	Profile rail, wiring comb field side, gray
	<b>K-DUCT-GY-UPR-03</b>	Profile rail with UPR-03-* insert, 3 conductors, wiring comb field side, gray

## Accessories

	<b>KC-ST-5GN</b>	Terminal block for KC modules, 2-pin screw terminal, green
	<b>KF-CP</b>	Red coding pins, packaging unit: 20 x 6

Release date: 2023-01-03 Date of issue: 2023-01-03 Filename: 214247\_eng.pdf

**Configuration**

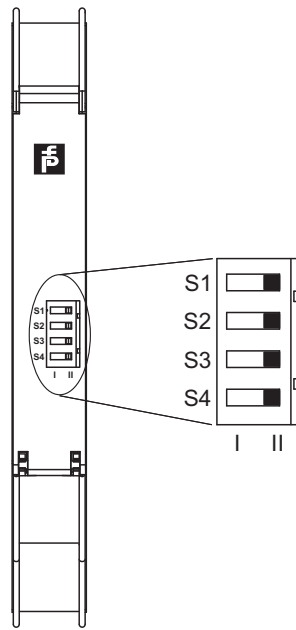

**Switch settings**

S	Function		Position
1	Mode of operation output I (active)	with high input current	I
		with low input current	II
2	Mode of operation output II (active)	with high input current	I
		with low input current	II
3	Line fault detection of the input I	ON	I
		OFF	II
4	Line fault detection of the input II	ON	I
		OFF	II

**Operating states**

Control circuit	Input signal
Initiator high impedance/contact opened	low input current
Initiator low impedance/contact closed	high input current
Lead breakage, lead short circuit	Line fault

Factory setting: switch 1, 2, 3 and 4 in position I

Release date: 2023-01-03 Date of issue: 2023-01-03 Filename: 214247\_eng.pdf

Refer to "General Notes Relating to Pepperl+Fuchs Product Information".