



Safety thru-beam sensor transmitter SLA12-LAS-T/124



- Sensing range 12 m
- Visible red light, pulsed LASER light
- Laser class 1, eyesafe
- Performance Level PL e
- Clearly visible LED functional display and pre-fault indicator on the receiver
- Sturdy housing
- Waterproof, degree of protection IP67
- Operation on SB4-series control units (SafeBox)

Safety thru-beam sensor with laser



Dimensions

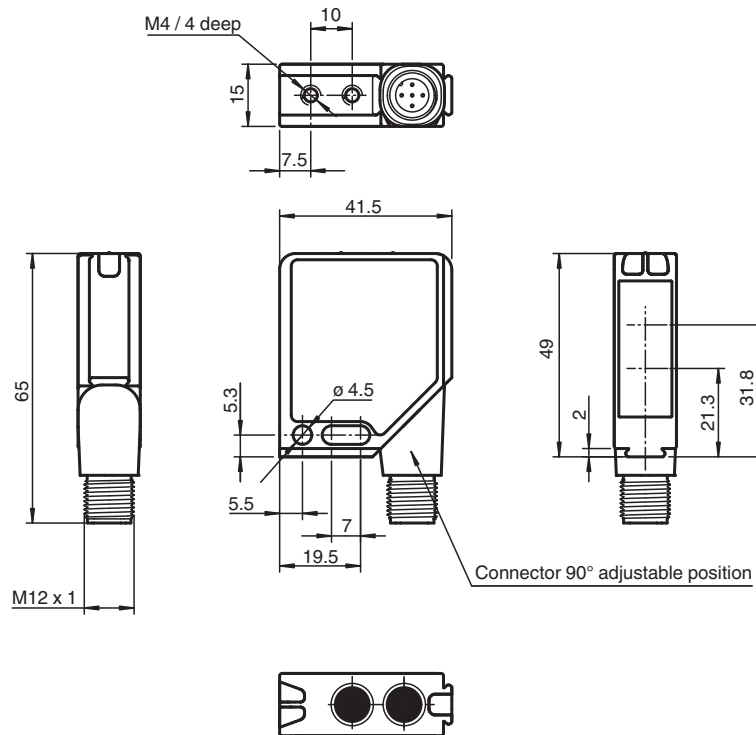

Technical Data

System components

Emitter	SLA12-LAS-T/124
Receiver	SLA12-R/124

Release date: 2023-02-15 Date of issue: 2023-02-15 Filename: 214723_eng.pdf

Refer to "General Notes Relating to Pepperl+Fuchs Product Information".

Pepperl+Fuchs Group
www.pepperl-fuchs.com

USA: +1 330 486 0001
fa-info@us.pepperl-fuchs.com

Germany: +49 621 776 1111
fa-info@de.pepperl-fuchs.com

Singapore: +65 6779 9091
fa-info@sg.pepperl-fuchs.com

PF PEPPERL+FUCHS

Technical Data

General specifications		
Effective detection range		0.2 ... 12 m
Light source		laser diode
Light type		modulated visible red light
Laser nominal ratings		
Note		LASER LIGHT , DO NOT STARE INTO BEAM
Laser class		1
Wave length		650 nm
Beam divergence		1 mrad
Pulse length		35 µs
Repetition rate		200 Hz
Target size		static: 10 mm dynamic: 30 mm (at v = 1.6 m/s of the obstacle)
Alignment aid		LED red
Opening angle		< 5 °
Functional safety related parameters		
Safety Integrity Level (SIL)		SIL 3
Performance level (PL)		PL e
Category		Cat. 4
Mission Time (T _M)		20 a
PFH _d		4.4 E-10
Type		4
Indicators/operating means		
Operation indicator		LED green
Function indicator		LED yellow: 1. LED lit constantly: signal > 2 x switching point (function reserve) 2. LED flashes: signal between 1 x switching point and 2 x switching point 3. LED off: signal < switching point
Electrical specifications		
Operating voltage	U _B	Power supply via control unit
Protection class		III , IEC 61140
Conformity		
Functional safety		ISO 13849-1
Product standard		EN 61496-1 ; IEC 61496-2
Laser safety		IEC 60825-1:2007
Approvals and certificates		
CE conformity		CE
UKCA conformity		UKCA
UL approval		
TÜV approval		TÜV SÜD
Ambient conditions		
Ambient temperature		0 ... 50 °C (32 ... 122 °F)
Storage temperature		-20 ... 70 °C (-4 ... 158 °F)
Relative humidity		max. 95 %, not condensing
Shock resistance		10 g , 16 ms ; stationary applications only
Vibration resistance		1 mm , 10 ... 55 Hz ; stationary applications only
Mechanical specifications		
Degree of protection		IP67 according to EN 60529
Connection		5-pin M12 x 1 connector with metal thread, 90° rotatable
Material		
Housing		Frame: nickel plated, die cast zinc, Laterals: glass-fiber reinforced plastic PC RAL 1021 (yellow)
Optical face		Plastic pane
Mass		per device 60 g

Release date: 2023-02-15 Date of issue: 2023-02-15 Filename: 214723_eng.pdf

Refer to "General Notes Relating to Pepperl+Fuchs Product Information".

Pepperl+Fuchs Group
www.pepperl-fuchs.comUSA: +1 330 486 0001
fa-info@us.pepperl-fuchs.comGermany: +49 621 776 1111
fa-info@de.pepperl-fuchs.comSingapore: +65 6779 9091
fa-info@sg.pepperl-fuchs.com

PEPPERL+FUCHS

Connection

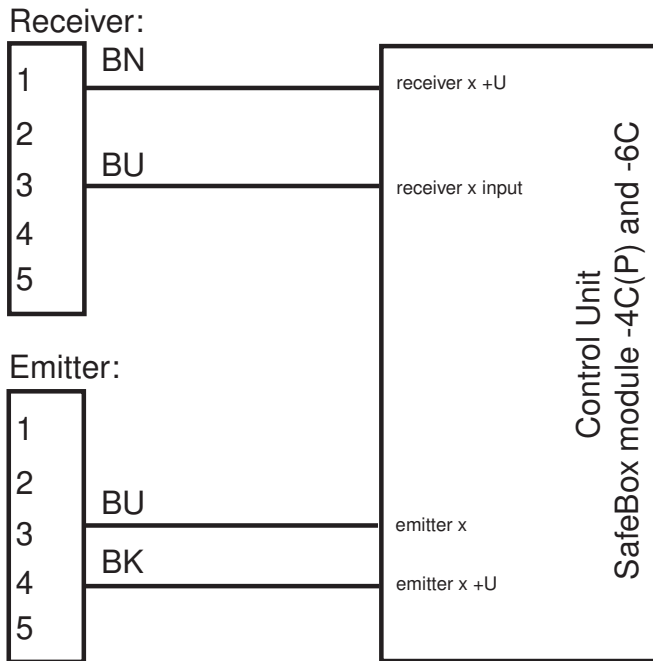

Connection Assignment

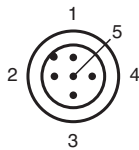

Assembly

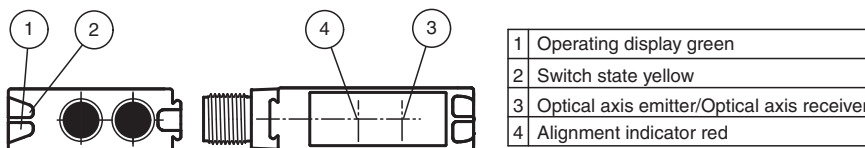

Release date: 2023-02-15 Date of issue: 2023-02-15 Filename: 214723_eng.pdf

Refer to "General Notes Relating to Pepperl+Fuchs Product Information".

Characteristic Curve

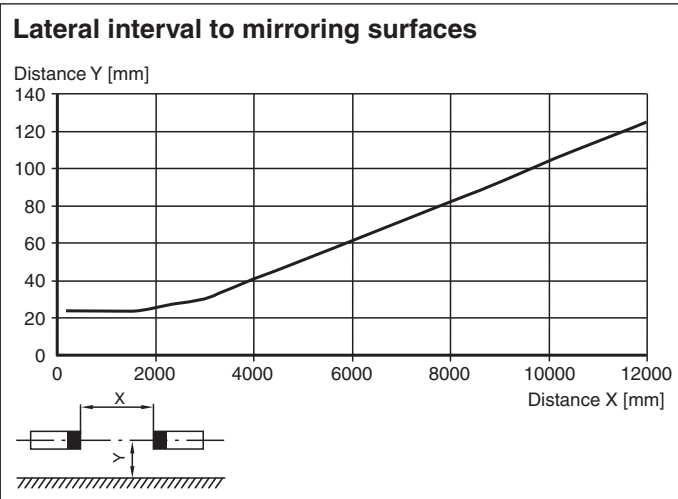
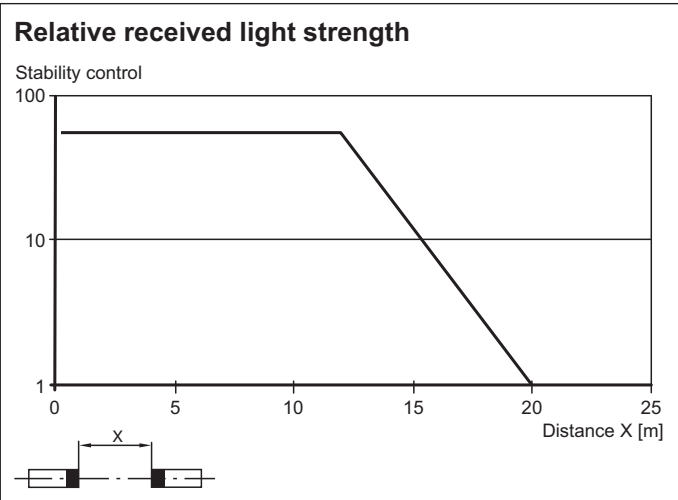
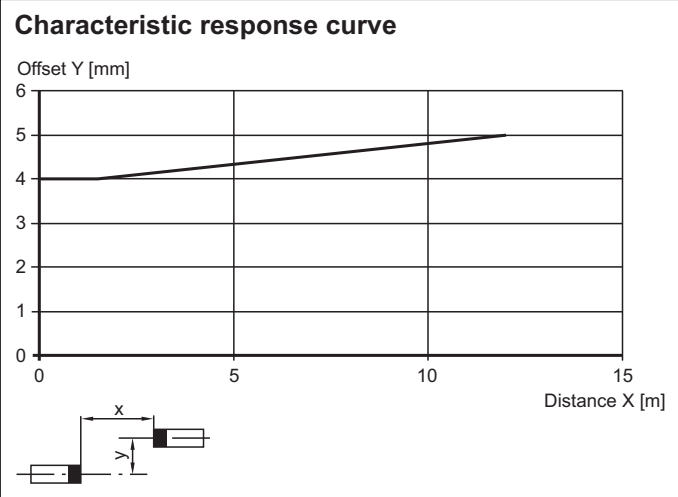

Safety Information







Laser Class 1 Information

The irradiation can lead to irritation especially in a dark environment. Do not point at people!
 Maintenance and repairs should only be carried out by authorized service personnel!
 Attach the device so that the warning is clearly visible and readable.
 The warning accompanies the device and should be attached in immediate proximity to the device.
 Caution – Use of controls or adjustments or performance of procedures other than those specified herein may result in hazardous radiation exposure.

Release date: 2023-02-15 Date of issue: 2023-02-15 Filename: 214723_eng.pdf

Refer to "General Notes Relating to Pepperl+Fuchs Product Information".

Accessories

	SLA-1-M	Deviation mirror
	OMH-06	Mounting aid for round steel \varnothing 12 mm or sheet 1.5 mm ... 3 mm
	OMH-MLV12-HWG	Mounting bracket for series MLV12 sensors
	OMH-MLV12-HWK	Mounting bracket for series MLV12 sensors
	OMH-K01	dove tail mounting clamp
	OMH-K02	dove tail mounting clamp
	V15-W-5M-PVC	Female cordset single-ended M12 angled A-coded, 5-pin, PVC cable grey

Indication

Additional information

For much easier alignment even for long distance applications, an additional red LED is located in the receiver's optics:

- LED constantly illuminated:
signal strength < switching level
- LED flashes:
signal strength is between 1-fold switching level and 2-fold switching level
- LED off:
signal strength < 2-fold switching level (function reserve)