

Connection cable

V1-W-OR0,6M-POC-V1-W



- Welding-bead resistant
- Suitable for robotic applications / torsion resistant
- Degree of protection IP68 / IP69
- Free of paint wetting interfering substances
- Ozone resistant
- Hydrolysis resistant
- Oil resistant
- Halogen-free
- Specific design protects against loosening and inaccurate installation

Cordset M12 socket angled to M12 plug angled A-coded, 4-pin, POC cable welding-bead resistant orange, suitable for robotic applications, torsion resistant, oil resistant, molecularly cross-linked



Dimensions

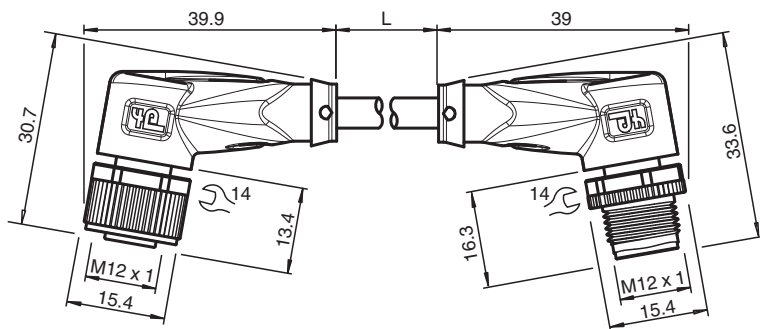

Technical Data

General specifications

Connector 1		
Connection		socket
Construction type		M12
Style		angled
Locking		screw connection
Number of pins		4
Coding		A-coded
Connector 2		
Connection		plug
Construction type		M12
Style		angled
Locking		screw connection
Number of pins		4
Coding		A-coded

Electrical specifications

Operating voltage	U_B	max. 250 V AC/DC
Operating current	I_B	max. 4 A

Conformity

Degree of protection		EN 60529
----------------------	--	----------

Release date: 2023-07-13 Date of issue: 2023-07-13 Filename: 216708_eng.pdf

Refer to "General Notes Relating to Pepperl+Fuchs Product Information".

Pepperl+Fuchs Group
www.pepperl-fuchs.com

USA: +1 330 486 0001
fa-info@us.pepperl-fuchs.com

Germany: +49 621 776 1111
fa-info@de.pepperl-fuchs.com

Singapore: +65 6779 9091
fa-info@sg.pepperl-fuchs.com

PEPPERL+FUCHS

Technical Data

Plug connection		connector M12 x 1 : IEC 61076-2-101
Flammability		IEC 60332-1-2 , ISO 14572 , ISO 6722
Halogen-free		IEC 60754-2
Hydrolysis resistance		ISO 6722
Oil resistance		ISO 14572
Ambient conditions		
Ambient temperature		
Plug connector		-40 ... 90 °C (-40 ... 194 °F)
Cable, fixed		-40 ... 120 °C (-40 ... 248 °F) for 20000 h -40 ... 150 °C (-40 ... 302 °F) for 3000 h
Cable, flexing		-15 ... 120 °C (5 ... 248 °F) for 20000 h -15 ... 150 °C (5 ... 302 °F) for 3000 h
Pollution degree		3
Mechanical specifications		
Plug connector		
Tightening torque		0.6 Nm
Loosening protection		available
Tool installation		straight knurling and hexagon nut SW = 14 mm
Mating cycles		min. 100
Degree of protection		IP68 / IP69
Cable		according to IEC/EN 60228 (DIN VDE 0295) class 5
Sheath diameter		4.8 mm
Bending radius		> 10 x cable diameter, moving > 10 x cable diameter, fixed
Sheath stripping force		max. 50 N / 300 mm
Sheath color		orange (similar to RAL 2003)
Number of cores		4
Core cross section		0.34 mm ²
Cores color		Core 1: brown Core 2: white Core 3: blue Core 4: black
Core construction		19 x 0.16 mm Ø
Length	L	0.6 m
Cable code		Li 7Y 41X 4 x 0,34
Drag chain suitability		
Torsion cycles		min. 300000
Torsional stress		± 360 °/ 30 cm
Material		
PWIS free		yes
Halogen-free		yes
Plug connector		
Screw connection		Zinc diecast, nickel-plated
Body		TPU, black
Seal		FKM
Contact surface		gold plated (Au)
Flammability		V-2
Cable		
Sheathing		POC
Core insulation		ETFE
Welding-bead resistance		yes
Weld spatter resistance		yes
Oil resistance		yes
Hydrolysis resistance		yes
Flammability		flame-resistant

Release date: 2023-07-13 Date of issue: 2023-07-13 Filename: 216708_eng.pdf





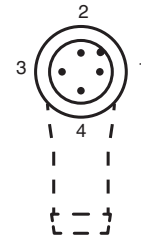
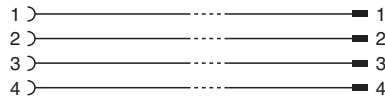
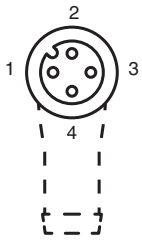

Technical Data

Molecularly cross-linked yes

Connection



Accessories

	MH V1-SCREWDRIVER	Torque screwdriver (0.6 Nm)
	MH V1-BIT M12	plug-in cap M12
	V1/V3-LABELHOLDER	Label holder
	V1/V3-LABEL	Label plate
	MH V1-Holder	Modular universal holder for M12 connectors
	V1-CLIP	Unlocking protector for M12 connector
	V1-MARKING-RING-COLOR	Marking rings for M12 connectors, various colors