



Adapter cable V1S-G-0,15M-PUR-ABG-SUBD

- Halogen-free
- Knurled nut suitable for tool assembly
- Immunity to vibration, with mechanical latching

Adapter cable M12 plug straight A-coded 4-pin to Sub-D-plug straight 9-pin, PUR cable grey, shielded



Dimensions

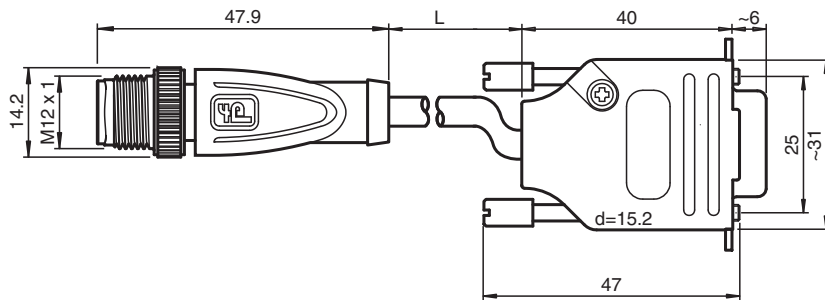

Technical Data

General specifications

Connector 1		
Connection		plug
Construction type		M12
Style		straight
Locking		screw connection
Number of pins		4
Coding		A-coded
Connector 2		
Connection		plug
Construction type		Sub-D
Style		straight
Locking		screw connection
Number of pins		9

Electrical specifications

Operating voltage	U_B	max. 36 V DC
Operating current	I_B	max. 1.5 A

Release date: 2023-05-04 Date of issue: 2023-05-04 Filename: 218823_eng.pdf

Refer to "General Notes Relating to Pepperl+Fuchs Product Information".

Pepperl+Fuchs Group
www.pepperl-fuchs.com

USA: +1 330 486 0001
fa-info@us.pepperl-fuchs.com

Germany: +49 621 776 1111
fa-info@de.pepperl-fuchs.com

Singapore: +65 6779 9091
fa-info@sg.pepperl-fuchs.com

PEPPERL+FUCHS

Technical Data

Conformity

Degree of protection		EN 60529
Plug connection		connector M12 x 1 : IEC 61076-2-101 Connector Sub-D : IEC 807-2
Halogen-free		DIN VDE 0472-815 DIN EN 50267-2-1

Ambient conditions

Ambient temperature		
Connector 1		-40 ... 90 °C (-40 ... 194 °F)
Connector 2		-55 ... 105 °C (-67 ... 221 °F)
Cable, fixed		-50 ... 105 °C (-58 ... 221 °F)
Cable, flexing		-30 ... 105 °C (-22 ... 221 °F)
Pollution degree		3

Mechanical specifications

Connector 1		
Tightening torque		0.6 Nm
Loosening protection		available
Tool installation		straight knurling
Mating cycles		min. 100
Shielding		shield connected to screw connection
Degree of protection		IP67 / IP68 / IP69
Connector 2		
Loosening protection		screws UNC 4-40
Mating cycles		min. 100
Shielding		shield connected to connector
Degree of protection		IP20
Cable		
according to IEC/EN 60228 (DIN VDE 0295) class 5		
Sheath diameter		4.8 mm
Bending radius		> 10 x cable diameter, moving > 5 x cable diameter, fixed
Sheath stripping force		max. 100 N / 300 mm
Sheath color		grey (similar to RAL 7001)
Number of cores		4
Core cross section		0.34 mm ²
Cores color		Core 1: not used Core 2-2: white Core 3-5: blue Core 4-3: black
Shield		tinned copper braiding, 85 % coverage
Length	L	0.15 m

Material





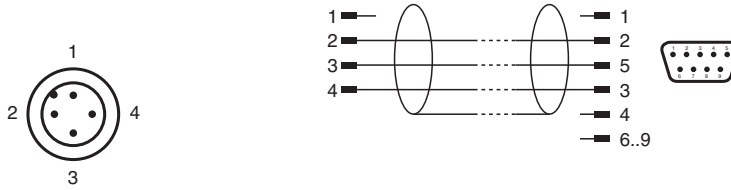

Halogen-free		yes
Connector 1		
Screw connection		Zinc diecast, nickel-plated
Body		TPU, black
Contact surface		Au
Flammability		V-2
Connector 2		
Body		Zinc diecast, nickel-plated
Contact surface		Au
Flammability		V-0
Cable		
Sheathing		PUR based on polyether
Core insulation		PP
Chemical resistance		good

Release date: 2023-05-04 Date of issue: 2023-05-04 Filename: 218823_eng.pdf

Connection Assignment



Accessories

	MH V1-SCREWDRIVER	Torque screwdriver (0.6 Nm)
	MH V1-BIT M12	plug-in cap M12
	V1/V3-LABELHOLDER	Label holder
	V1/V3-LABEL	Label plate
	MH V1-Holder	Modular universal holder for M12 connectors
	V1-CLIP	Unlocking protector for M12 connector
	V1-MARKING-RING-COLOR	Marking rings for M12 connectors, various colors