



Retroreflective sensor

MLV41-6-IO/95/136



- Rugged series in corrosion-resistant metal housing
- IO-Link interface for service and process data
- Extremely high switching frequency
- Clear and functional display concept for the operating modes
- Resistant against noise: reliable operation under all conditions
- Aluminum housing with high quality Delta-Seal coated

Robust retroreflective sensor, compact housing design, IO-Link interface, 9.5 m detection range, red light, 2 push-pull outputs, M8 plug



Function

The unique and extremely popular design of the MLV41 series enables it to be mounted correctly in confined areas and offers all the functions that are normally only found on larger photoelectric sensors. The MLV41 series comes with a range of functions. For example, highly visible status LEDs on the front and back, resistance to ambient light, crosstalk protection and universally applicable output stages that permit every possible switching logic and polarity to be realized. The enhanced resistance to ambient light ensures reliable operation even where modern energy-saving lamps with electronic ballasts are in use. The same applies where multiple devices are present, i.e. the use of a number of sensors in the same vicinity causes no problems.

Dimensions

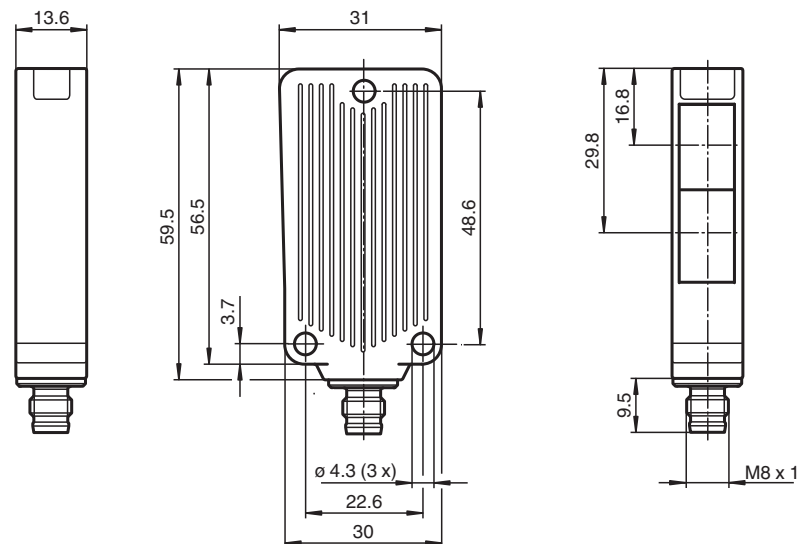

Technical Data

| General specifications | |
|--------------------------------------|---|
| Effective detection range | 0 ... 9.5 m |
| Reflector distance | Foil reflector 0.05 ... 3 m Retro-reflector 0.01 ... 9.5 m |
| Threshold detection range | 12 m |
| Reference target | OFR-22800/76 , H85-2 reflector |
| Light source | LED |
| Light type | modulated visible red light , 625 nm |
| Polarization filter | no |
| Angle deviation | max. $\pm 1.5^\circ$ |
| Diameter of the light spot | approx. 300 mm at detection range 8.5 m |
| Opening angle | 1.5° |
| Optical face | frontal |
| Ambient light limit | 20000 Lux |
| Functional safety related parameters | |
| MTTF _d | 940 a |
| Mission Time (T _M) | 20 a |
| Diagnostic Coverage (DC) | 0 % |
| Indicators/operating means | |
| Operation indicator | LED green, statically lit Power on , Undervoltage indicator: Green LED, pulsing (approx. 0.8 Hz) , short-circuit : LED green flashing (approx. 4 Hz) , IO link communication: green LED goes out briefly (1 Hz) |
| Function indicator | 2 LEDs yellow for switching state , Operating reserve |

Release date: 2023-04-04 Date of issue: 2023-04-04 Filename: 221592_eng.pdf

Refer to "General Notes Relating to Pepperl+Fuchs Product Information".

Pepperl+Fuchs Group
www.pepperl-fuchs.com

USA: +1 330 486 0001
fa-info@us.pepperl-fuchs.com

Germany: +49 621 776 1111
fa-info@de.pepperl-fuchs.com

Singapore: +65 6779 9091
fa-info@sg.pepperl-fuchs.com

 **PEPPERL+FUCHS**

Technical Data

| | | |
|-----------------------------------|-------|--|
| Control elements | | none |
| Electrical specifications | | |
| Operating voltage | U_B | 10 ... 30 V DC |
| Ripple | | max. 10 % |
| No-load supply current | I_0 | max. 30 mA |
| Interface | | |
| Interface type | | IO-Link |
| Protocol | | IO-Link V1.0 |
| Mode | | COM2 (38.4 kBit/s) |
| Output | | |
| Signal output | | 2 push-pull (4 in 1) outputs, complementary, short-circuit proof, reverse polarity protected |
| Switching voltage | | max. 30 V DC |
| Switching current | | max. 100 mA |
| Voltage drop | U_d | ≤ 2.5 V DC |
| Switching frequency | f | 1000 Hz |
| Response time | | 0.5 ms |
| Conformity | | |
| Product standard | | EN 60947-5-2 |
| Approvals and certificates | | |
| UL approval | | cULus Listed 57M3 (Only in association with UL Class 2 power supply; Type 1 enclosure) |
| CCC approval | | CCC approval / marking not required for products rated ≤ 36 V |
| Ambient conditions | | |
| Ambient temperature | | -40 ... 60 °C (-40 ... 140 °F) |
| Storage temperature | | -40 ... 75 °C (-40 ... 167 °F) |
| Mechanical specifications | | |
| Housing width | | 31 mm |
| Housing height | | 56.5 mm |
| Housing depth | | 13.6 mm |
| Degree of protection | | IP67 |
| Connection | | M8 x 1 connector, 4-pin |
| Material | | |
| Housing | | Aluminum , Delta-Seal coated |
| Optical face | | glass pane |
| Connector | | metal |
| Mass | | 50 g |

Connection Assignment

Option:

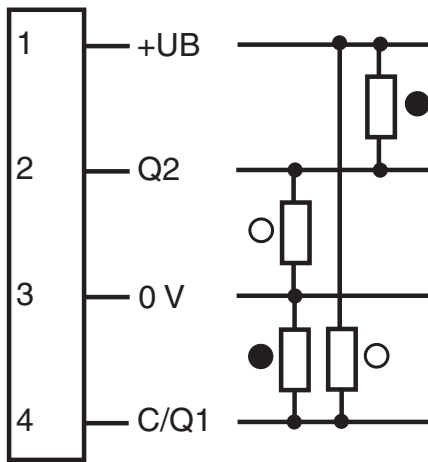

○ = Light on
● = Dark on

Connection Assignment



Wire colors in accordance with EN 60947-5-2

| | | |
|---|----|---------|
| 1 | BN | (brown) |
| 2 | WH | (white) |
| 3 | BU | (blue) |
| 4 | BK | (black) |

Assembly

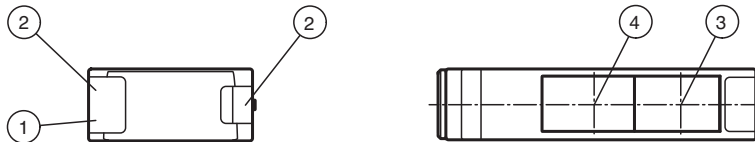

| | | | |
|---|-------------------------|---|--------------------------|
| 1 | Operating display green | 3 | Optical axis transmitter |
| 2 | Function display yellow | 4 | Optical axis receiver |

Release date: 2023-04-04 Date of issue: 2023-04-04 Filename: 221592_eng.pdf

Refer to "General Notes Relating to Pepperl+Fuchs Product Information".

Pepperl+Fuchs Group
www.pepperl-fuchs.com

USA: +1 330 486 0001
fa-info@us.pepperl-fuchs.com







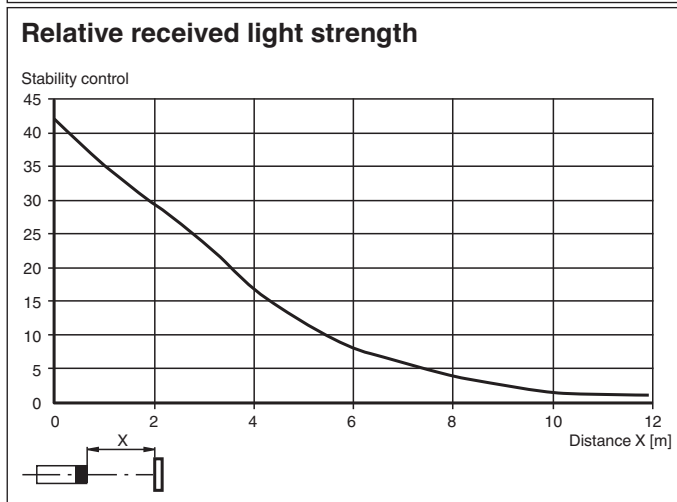
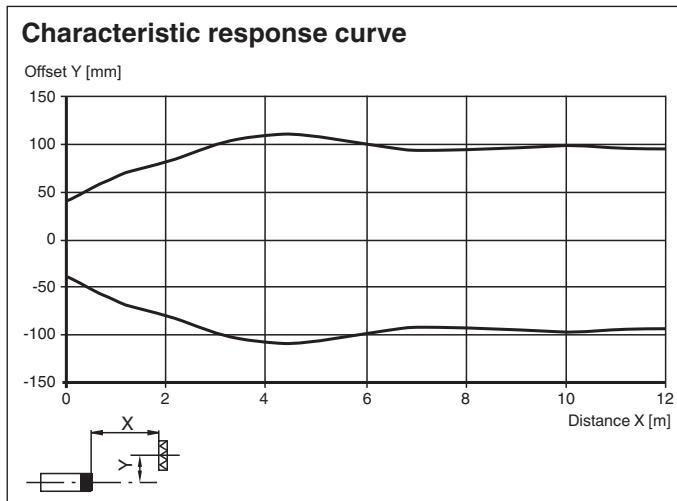

Germany: +49 621 776 1111
fa-info@de.pepperl-fuchs.com

Singapore: +65 6779 9091
fa-info@sg.pepperl-fuchs.com

Characteristic Curve











Accessories

| | | |
|---|---------------------|--|
|  | OMH-09 | Mounting bracket for Sensors series MLV41 for M12 rod mounting |
|  | OMH-40 | Mounting bracket |
|  | PACTware 4.1 | FDT Framework |
|  | REF-H85-2 | Reflector, rectangular 84.5 mm x 84.5 mm, mounting holes |
|  | REF-H50 | Reflector, rectangular 51 mm x 61 mm, mounting holes, fixing strap |
|  | REF-VR10 | Reflector, rectangular 60 mm x 19 mm, mounting holes |
|  | ORR50G | Reflector, rectangular 50.9 mm x 60.9 mm, mounting holes, fixing strap and polarization filter |
|  | OFR-100/100 | Reflective tape 100 mm x 100 mm |

Release date: 2023-04-04 Date of issue: 2023-04-04 Filename: 221592_eng.pdf

Accessories

| | | |
|---|-----------------------------|--|
|  | ICE2-8IOL-G65L-V1D | EtherNet/IP IO-Link master with 8 inputs/outputs |
|  | ICE3-8IOL-G65L-V1D | PROFINET IO IO-Link master with 8 inputs/outputs |
|  | ICE1-8IOL-G30L-V1D | Ethernet IO-Link module with 8 inputs/outputs |
|  | ICE1-8IOL-G60L-V1D | Ethernet IO-Link module with 8 inputs/outputs |
|  | ICE2-8IOL-K45P-RJ45 | EtherNet/IP IO-Link master with 8 inputs/outputs, DIN rail, push-in connectors |
|  | ICE2-8IOL-K45S-RJ45 | EtherNet/IP IO-Link master with 8 inputs/outputs, DIN rail, screw terminal |
|  | ICE3-8IOL-K45P-RJ45 | PROFINET IO IO-Link master with 8 inputs/outputs, DIN rail, push-in terminals |
|  | ICE3-8IOL-K45S-RJ45 | PROFINET IO IO-Link master with 8 inputs/outputs, DIN rail, screw terminal |
|  | IO-Link-Master02-USB | IO-Link master, supply via USB port or separate power supply, LED indicators, M12 plug for sensor connection |

IO link function

The IO link operating mode is indicated by the green LED indicator with a short interruption ($f = 1 \text{ Hz}$). IO link communication simultaneously provides process data (measurement data from the sensor) and access to requirement data.

The requirement data contains the following information:

Identification:

- Manufacturer information
- Product ID
- User-specific ID

Device parameters:

- Teach-in parameters
- Operating parameters
- Configuration parameters
- Device commands

Diagnostic messages and warnings