

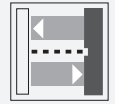

## Background suppression sensor MLV41-8-H-120-RT-IO/65b/98/103



- Rugged series in corrosion-resistant metal housing
- MPT Multi Pixel Technology
- IO-Link interface for service and process data
- Reliable detection of all surfaces, independent of color and structure
- Precision background suppression, adjustable
- Low sensitivity to target color
- Clear and functional display concept for the operating modes

Diffuse sensor with measurement core technology, compact housing design, background suppression and 3 further adjustable operating modes, IO-Link interface, 120 mm adjustable detection range, red light, 2 push-pull outputs, M8 plug



### Function

The diffuse mode sensor with MPT technology combines the benefits of the triangulation principle with the measuring functionality of a distance sensor. The integrated measuring principle provides an extremely wide range of switching element functions in one device, along with a large detection range and a small black/white difference up to the final detection range. The sensor is equipped with an IO-Link interface, through which the measuring principle is optimized to the requirements of the relevant application.

## Dimensions

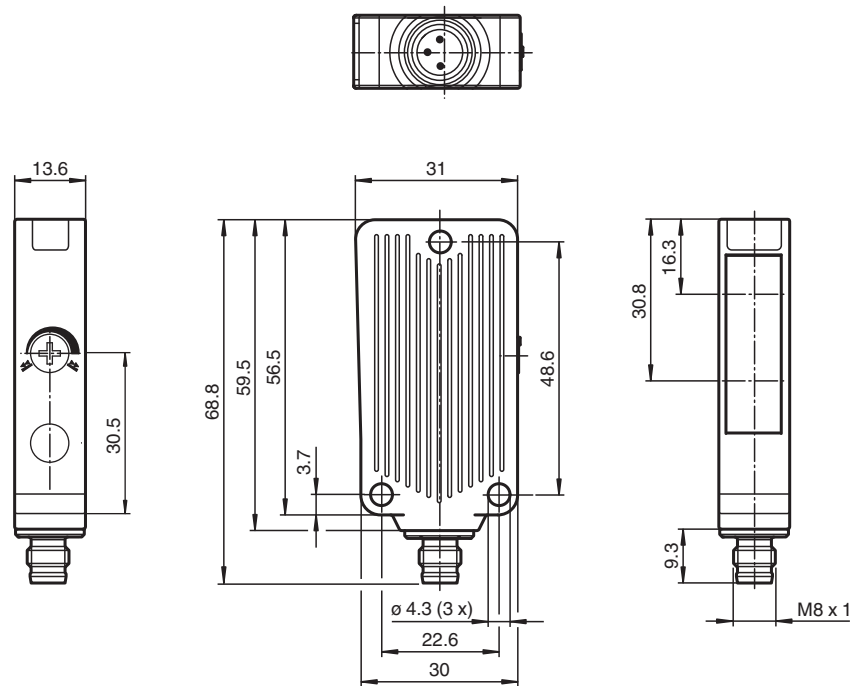

## Technical Data

### General specifications

Detection range	20 ... 120 mm Black-white difference < 3%
Adjustment range	20 ... 120 mm
Diagnosis range	20 ... 120 mm
Reference target	standard white, 100 mm x 100 mm
Light source	LED
Light type	modulated visible red light
Diameter of the light spot	approx. 4 mm at sensor range 100 mm
Opening angle	approx. 2.5 °
Ambient light limit	25000 Lux

### Functional safety related parameters

MTTF <sub>d</sub>	500 a
Mission Time (T <sub>M</sub> )	20 a
Diagnostic Coverage (DC)	0 %

### Indicators/operating means

Operation indicator	LED green, statically lit Power on , Undervoltage indicator: Green LED, pulsing (approx. 0.8 Hz) , short-circuit : LED green flashing (approx. 4 Hz)
Function indicator	2 LEDs yellow ON: object inside the scanning range OFF: object outside the scanning range
Control elements	Sensing range adjuster
Parameterization indicator	IO link communication: green LED goes out briefly (1 Hz)

### Electrical specifications

Release date: 2022-03-30 Date of issue: 2022-03-30 Filename: 222741\_eng.pdf

Refer to "General Notes Relating to Pepperl+Fuchs Product Information".

Pepperl+Fuchs Group  
www.pepperl-fuchs.com

USA: +1 330 486 0001  
fa-info@us.pepperl-fuchs.com

Germany: +49 621 776 1111  
fa-info@de.pepperl-fuchs.com

Singapore: +65 6779 9091  
fa-info@sg.pepperl-fuchs.com

 PEPPERL+FUCHS

## Technical Data

Operating voltage	$U_B$	10 ... 30 V DC , class 2
Ripple		max. 10 %
No-load supply current	$I_0$	max. 25 mA at 24 V supply voltage
<b>Interface</b>		
Interface type		IO-Link
Protocol		IO-Link V1.0
Mode		COM2 (38.4 kBaud)
<b>Output</b>		
Switching type		dark-on
Signal output		1 PNP output, short-circuit protected, reverse polarity protected, open collector
Switching voltage		max. 30 V DC
Switching current		max. 100 mA
Voltage drop	$U_d$	$\leq 2$ V DC
Switching frequency	$f$	200 Hz
Response time		2.5 ms
<b>Conformity</b>		
Product standard		EN 60947-5-2
<b>Approvals and certificates</b>		
EAC conformity		TR CU 020/2011
UL approval		cULus Listed 57M3 (Only in association with UL Class 2 power supply; Type 1 enclosure)
CCC approval		CCC approval / marking not required for products rated $\leq 36$ V
<b>Ambient conditions</b>		
Ambient temperature		-20 ... 60 °C (-4 ... 140 °F) 60 ... 70 °C (140 ... 158 °F) ; max. 20,000 hours = 2.5 years (continuous operation)
Storage temperature		-40 ... 75 °C (-40 ... 167 °F)
<b>Mechanical specifications</b>		
Housing width		31 mm
Housing height		56.5 mm
Housing depth		13.6 mm
Degree of protection		IP67
Connection		M8 x 1 connector, 3-pin
Material		
Housing		Aluminum , Delta-Seal coated
Optical face		glass pane
Connector		metal
Mass		approx. 40 g

**Connection Assignment**

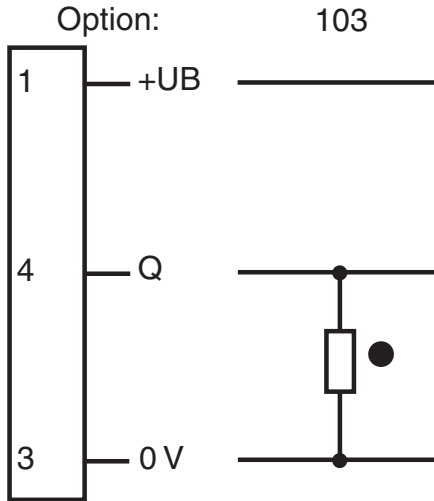

○ = Light on  
● = Dark on

**Connection Assignment**



Wire colors in accordance with EN 60947-5-2

- 1 | BN (brown)
- 3 | BU (blue)
- 4 | BK (black)

**Assembly**

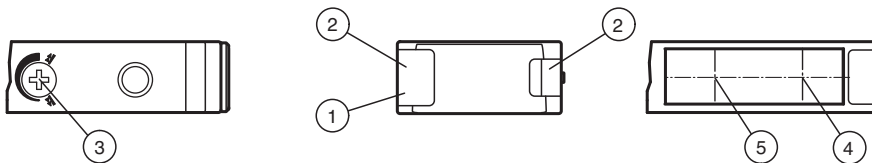

1	Operating display green	3	Sensing range adjuster	5	Optical axis receiver
2	Function display yellow	4	Optical axis transmitter		







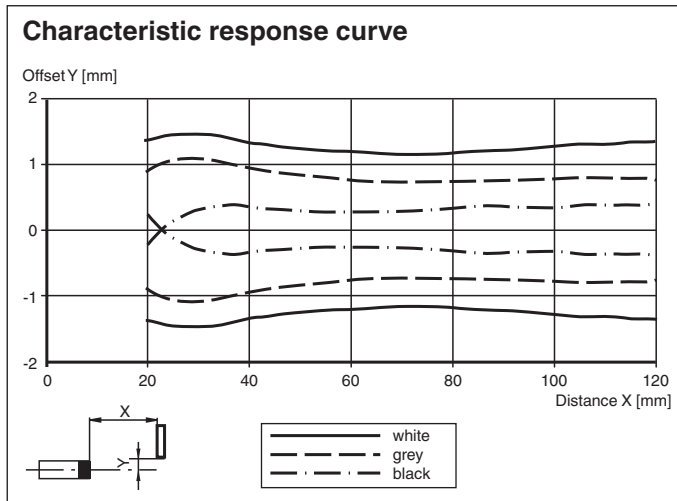





Release date: 2022-03-30 Date of issue: 2022-03-30 Filename: 222741\_eng.pdf

Refer to "General Notes Relating to Pepperl+Fuchs Product Information".

## Characteristic Curve



## Accessories

	<b>OMH-09</b>	Mounting bracket for Sensors series MLV41 for M12 rod mounting
	<b>OMH-40</b>	Mounting bracket
	<b>V3-WM-2M-PUR</b>	Female cordset single-ended M8 angled A-coded, 3-pin, PUR cable grey
	<b>ICE2-8IOL-G65L-V1D</b>	EtherNet/IP IO-Link master with 8 inputs/outputs
	<b>ICE3-8IOL-G65L-V1D</b>	PROFINET IO IO-Link master with 8 inputs/outputs
	<b>ICE1-8IOL-G30L-V1D</b>	Ethernet IO-Link module with 8 inputs/outputs
	<b>ICE1-8IOL-G60L-V1D</b>	Ethernet IO-Link module with 8 inputs/outputs
	<b>ICE2-8IOL-K45P-RJ45</b>	EtherNet/IP IO-Link master with 8 inputs/outputs, DIN rail, push-in connectors
	<b>ICE2-8IOL-K45S-RJ45</b>	EtherNet/IP IO-Link master with 8 inputs/outputs, DIN rail, screw terminal
	<b>ICE3-8IOL-K45P-RJ45</b>	PROFINET IO IO-Link master with 8 inputs/outputs, DIN rail, push-in terminals
	<b>ICE3-8IOL-K45S-RJ45</b>	PROFINET IO IO-Link master with 8 inputs/outputs, DIN rail, screw terminal
	<b>IO-Link-Master02-USB</b>	IO-Link master, supply via USB port or separate power supply, LED indicators, M12 plug for sensor connection

**Configuration**

**Detection range adjustment:**

The detection range can be set via the rotary switch or the IO-Link.

**Setting using the rotary switch:**

If you would like to change the detection range on the sensor, turn:

- the rotary switch to the left to reduce the value.
- the rotary switch to the right to increase the value.

With the IO-Link, the set detection range the current rotary switch configuration is always assigned. If the rotary switch is too far to the left or the right, perform the following:

Increasing the detection range:

Turn the potentiometer completely to the right until it stops. The LED will briefly flash green. The assignment of the current rotary switch configuration to the detection range set via IO-Link is overridden. Now set the desired detection range again.

Reducing the detection range:

Turn the potentiometer completely to the left until it stops. The LED will briefly flash green. The assignment of the current rotary switch configuration to the detection range set via IO-Link is overridden. Now set the desired detection range again.

**Example application - manually reduce detection range:**



The potentiometer has one position as shown here. The adjustable detection range is 20 mm ... 120 mm and is set via IO-Link to 100 mm. The rotary switch is too far to the left to set a detection range of 40 mm for example.



Turn the potentiometer to the right until it stops to override the set value to this rotary switch configuration. The LED will briefly flash green.



Now set the desired detection range again between 20 mm ... 120 mm.

**Configuration**

**Setting different operating modes via IO-Link interface**

The devices have an IO-Link interface as standard for diagnostic and parameterization tasks enabling optimum adaptation of the sensors to the application. In addition, four different operating modes can be set:

**Background suppression operating mode (1 or 2 switching points):**

- Detection of objects irrespective of type and color in a defined sensing range. Objects in the background are reliably suppressed
- Background suppression with 2 switching points



**Background evaluation operating mode:**

- Detection of objects irrespective of type and color against a defined background. Reliable detection of objects at close range (detection range  $\geq 0$  mm). The background serves as reference

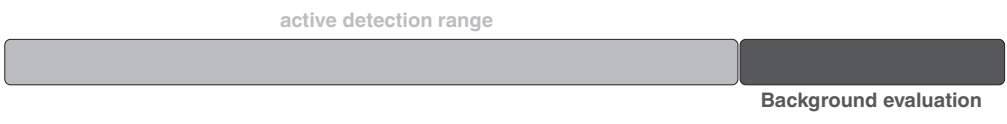

**Window operation operating mode:**

- Detection of objects irrespective of type and color in a defined sensing range. Reliable detection when leaving the defined sensing range.



**Hysteresis operating mode:**

Release date: 2022-03-30 Date of issue: 2022-03-30 Filename: 222741\_eng.pdf

Refer to "General Notes Relating to Pepperl+Fuchs Product Information".

- Detection of objects irrespective of type and color between a defined switch-on and switch-off point

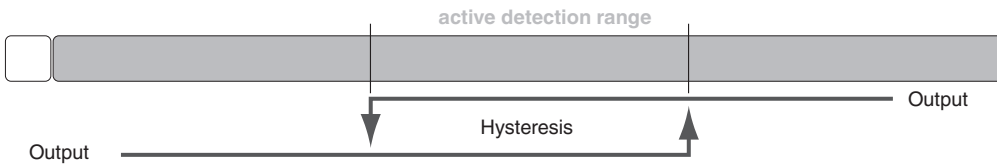

To use the diagnostic and parameterization options, you will find the compatible IODD, and if required, the FDT base application PACTware in the download area at [www.pepperl-fuchs.com](http://www.pepperl-fuchs.com).