

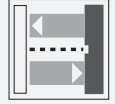

## Background suppression sensor MLV41-8-H-500-RT-IO/65b/95/136



- Rugged series in corrosion-resistant metal housing
- MPT Multi Pixel Technology
- IO-Link interface for service and process data
- Reliable detection of all surfaces, independent of color and structure
- Precision background suppression, adjustable
- Low sensitivity to target color
- Clear and functional display concept for the operating modes

Diffuse sensor with measurement core technology, compact housing design, background suppression and 3 further adjustable operating modes, IO-Link interface, 500 mm adjustable detection range, red light, 2 push-pull outputs, M8 plug



### Function

The diffuse mode sensor with MPT technology combines the benefits of the triangulation principle with the measuring functionality of a distance sensor. The integrated measuring principle provides an extremely wide range of switching element functions in one device, along with a large detection range and a small black/white difference up to the final detection range. The sensor is equipped with an IO-Link interface, through which the measuring principle is optimized to the requirements of the relevant application.

## Dimensions

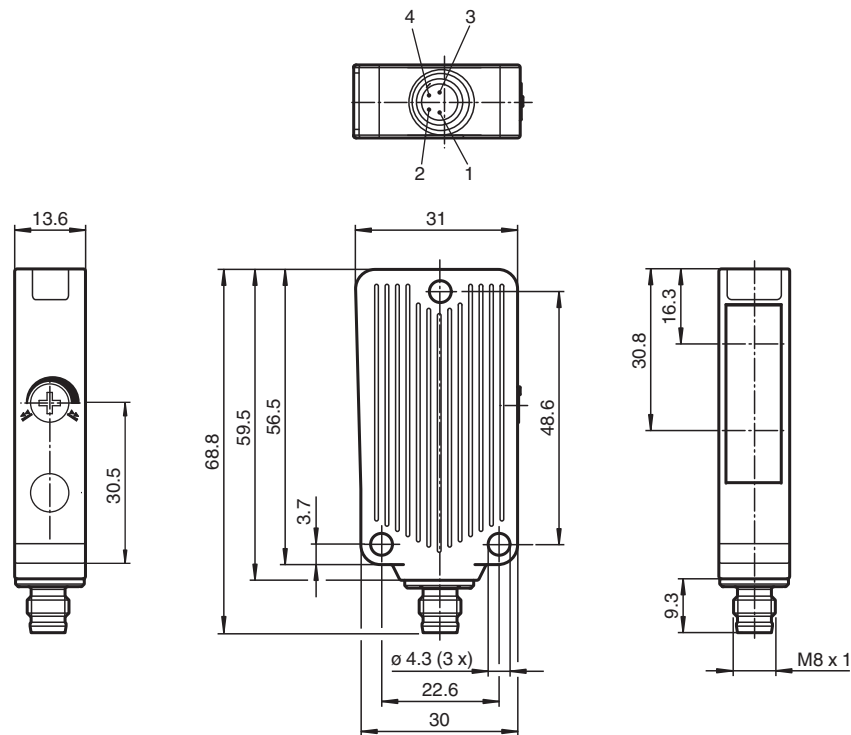

## Technical Data

### General specifications

Detection range	20 ... 500 mm Black-white difference < 5%
Adjustment range	40 ... 500 mm
Diagnosis range	20 ... 500 mm
Reference target	standard white, 100 mm x 100 mm
Light source	LED
Light type	modulated visible red light
Diameter of the light spot	approx. 25 mm at sensor range 500 mm
Opening angle	approx. 3 °
Ambient light limit	25000 Lux

### Functional safety related parameters

MTTF <sub>d</sub>	500 a
Mission Time (T <sub>M</sub> )	20 a
Diagnostic Coverage (DC)	0 %

### Indicators/operating means

Operation indicator	LED green, statically lit Power on , Undervoltage indicator: Green LED, pulsing (approx. 0.8 Hz) , short-circuit : LED green flashing (approx. 4 Hz)
Function indicator	2 LEDs yellow ON: object inside the scanning range OFF: object outside the scanning range
Control elements	Sensing range adjuster
Parameterization indicator	IO link communication: green LED goes out briefly (1 Hz)

### Electrical specifications

Release date: 2023-04-04 Date of issue: 2023-04-04 Filename: 222770\_eng.pdf

Refer to "General Notes Relating to Pepperl+Fuchs Product Information".

Pepperl+Fuchs Group  
www.pepperl-fuchs.com

USA: +1 330 486 0001  
fa-info@us.pepperl-fuchs.com

Germany: +49 621 776 1111  
fa-info@de.pepperl-fuchs.com

Singapore: +65 6779 9091  
fa-info@sg.pepperl-fuchs.com

 PEPPERL+FUCHS

## Technical Data

Operating voltage	$U_B$	10 ... 30 V DC , class 2
Ripple		max. 10 %
No-load supply current	$I_0$	max. 25 mA at 24 V supply voltage
<b>Interface</b>		
Interface type		IO-Link
Protocol		IO-Link V1.0
Mode		COM2 (38.4 kBit/s)
<b>Output</b>		
Switching type		dark-on
Signal output		2 push-pull (4 in 1) outputs, short-circuit protected, reverse polarity protected
Switching voltage		max. 30 V DC
Switching current		max. 100 mA
Voltage drop	$U_d$	$\leq 2$ V DC
Switching frequency	$f$	200 Hz
Response time		2.5 ms
<b>Conformity</b>		
Product standard		EN 60947-5-2
<b>Approvals and certificates</b>		
UL approval		cULus Listed 57M3 (Only in association with UL Class 2 power supply; Type 1 enclosure)
CCC approval		CCC approval / marking not required for products rated $\leq 36$ V
<b>Ambient conditions</b>		
Ambient temperature		-20 ... 60 °C (-4 ... 140 °F)
Storage temperature		-40 ... 75 °C (-40 ... 167 °F)
<b>Mechanical specifications</b>		
Housing width		31 mm
Housing height		56.5 mm
Housing depth		13.6 mm
Degree of protection		IP67
Connection		M8 x 1 connector, 4-pin
<b>Material</b>		
Housing		Aluminum , Delta-Seal coated
Optical face		glass pane
Connector		metal
Mass		approx. 40 g

## Connection Assignment

Option:

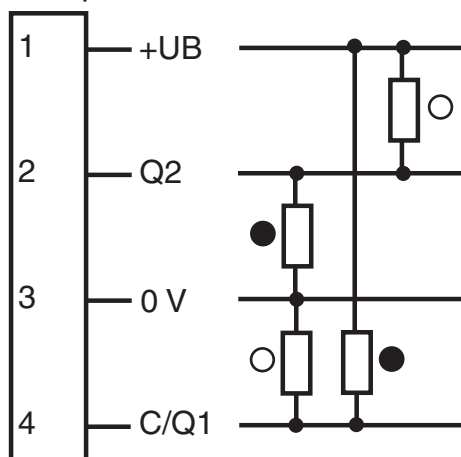

- = Light on
- = Dark on

## Connection Assignment



Wire colors in accordance with EN 60947-5-2

1	BN	(brown)
2	WH	(white)
3	BU	(blue)
4	BK	(black)

## Assembly

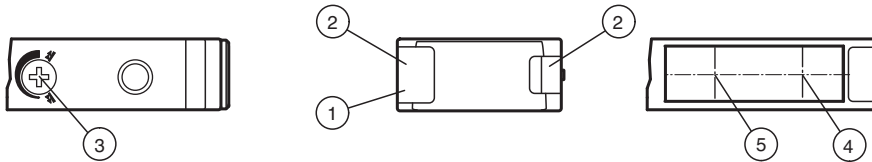

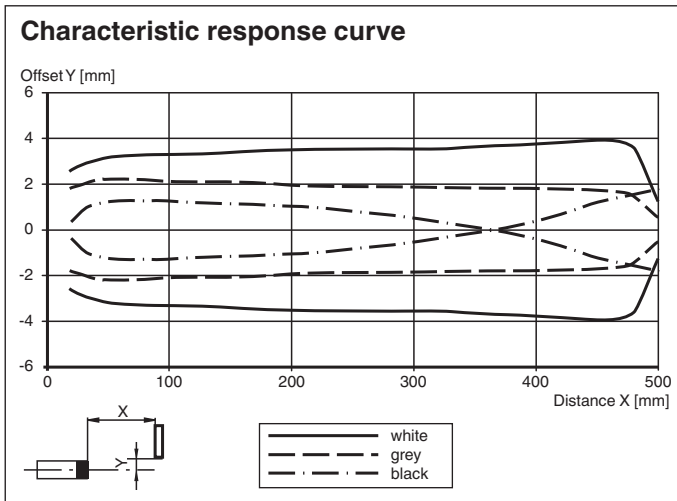

1	Operating display green	3	Sensing range adjuster	5	Optical axis receiver
2	Function display yellow	4	Optical axis transmitter		

## Characteristic Curve













## Accessories

	<b>OMH-09</b>	Mounting bracket for Sensors series MLV41 for M12 rod mounting
	<b>OMH-40</b>	Mounting bracket

Release date: 2023-04-04 Date of issue: 2023-04-04 Filename: 222770\_eng.pdf

## Accessories

	<b>V31-WM-2M-PUR</b>	Female cordset single-ended M8 angled A-coded, 4-pin, PUR cable grey
	<b>V31-GM-2M-PUR</b>	Female cordset single-ended M8 straight A-coded, 4-pin, PUR cable grey
	<b>ICE2-8IOL-G65L-V1D</b>	EtherNet/IP IO-Link master with 8 inputs/outputs
	<b>ICE3-8IOL-G65L-V1D</b>	PROFINET IO IO-Link master with 8 inputs/outputs
	<b>ICE1-8IOL-G30L-V1D</b>	Ethernet IO-Link module with 8 inputs/outputs
	<b>ICE1-8IOL-G60L-V1D</b>	Ethernet IO-Link module with 8 inputs/outputs
	<b>ICE2-8IOL-K45P-RJ45</b>	EtherNet/IP IO-Link master with 8 inputs/outputs, DIN rail, push-in connectors
	<b>ICE2-8IOL-K45S-RJ45</b>	EtherNet/IP IO-Link master with 8 inputs/outputs, DIN rail, screw terminal
	<b>ICE3-8IOL-K45P-RJ45</b>	PROFINET IO IO-Link master with 8 inputs/outputs, DIN rail, push-in terminals
	<b>ICE3-8IOL-K45S-RJ45</b>	PROFINET IO IO-Link master with 8 inputs/outputs, DIN rail, screw terminal
	<b>IO-Link-Master02-USB</b>	IO-Link master, supply via USB port or separate power supply, LED indicators, M12 plug for sensor connection

**Configuration**

**Detection range adjustment:**

The detection range can be adjusted between 40 mm and 500 mm via the rotary switch or IO-Link. For finer adjustment, the adjustable detection range is divided into several subranges which can be selected using Page Up/Down.

The value set with IO-Link is always assigned the current rotary switch configuration.

**Setting using the rotary switch:**

Increasing the detection range:

Turn the potentiometer to the right. If the desired detection range is not reached, turn the potentiometer to the right until it stops (Page Up). The green LED will flash briefly. Now set the desired detection range again.

Reducing the detection range:

Turn the potentiometer to the left. If the desired detection range is not reached, turn the potentiometer to the left until it stops (Page Down). The green LED will flash briefly. Now set the desired detection range again.

**Example application: manually reduce detection range from 450 mm to 60 mm:**



The potentiometer has a position as shown here, but works with a 450 mm detection range.



Now turn the potentiometer completely to the left until it stops (Page Down). The green LED will flash briefly.



Now set the detection range to 60 mm. If the desired detection range cannot be set, turn the potentiometer again to the left until it stops (Page Down) and repeat the procedure.

**Configuration**

**Setting different operating modes via IO-Link interface**

The devices have an IO-Link interface as standard for diagnostic and parameterization tasks enabling optimum adaptation of the sensors to the application. In addition, four different operating modes can be set:

**Background suppression operating mode (1 or 2 switching points):**

- Detection of objects irrespective of type and color in a defined sensing range. Objects in the background are reliably suppressed
- Background suppression with 2 switching points



**Background evaluation operating mode:**

- Detection of objects irrespective of type and color against a defined background. Reliable detection of objects at close range (detection range  $\geq 0$  mm). The background serves as reference



**Window operation operating mode:**

- Detection of objects irrespective of type and color in a defined sensing range. Reliable detection when leaving the defined sensing range.



**Hysteresis operating mode:**

- Detection of objects irrespective of type and color between a defined switch-on and switch-off point

Release date: 2023-04-04 Date of issue: 2023-04-04 Filename: 222770\_eng.pdf

Refer to "General Notes Relating to Pepperl+Fuchs Product Information".

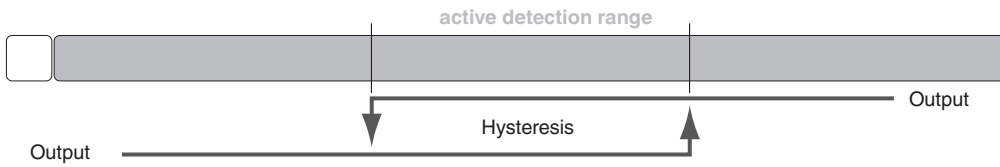

To use the diagnostic and parameterization options, you will find the compatible IODD, and if required, the FDT base application PACTware in the download area at [www.pepperl-fuchs.com](http://www.pepperl-fuchs.com).

Release date: 2023-04-04 Date of issue: 2023-04-04 Filename: 222770\_eng.pdf