

Frequency Converter with Direction and Synchronization Monitor

KFD2-UFT-2.D

- 2-channel signal conditioner
- 24 V DC supply (Power Rail)
- Dry contact or NAMUR inputs
- Input frequency 1 mHz ... 1 kHz
- Current output 0/4 mA ... 20 mA
- Relay contact and transistor output
- Start-up override
- Configurable by PACTware or keypad
- Line fault detection (LFD)



Function

This signal conditioner analyzes 2 digital signals (NAMUR sensor/mechanical contact) and functions as a rotation direction indicator, slip monitor, frequency monitor or synchronization monitor. Each proximity sensor or switch controls a passive transistor output. The 2 relay outputs indicate if the input signal is above or below the trip value or the rotational direction. The analog output can be programmed to be proportional to the input frequency or slip differential. The unit is easily programmed by the use of a keypad located on the front of the unit or with the PACTware™ configuration software. Line fault detection of the field current is indicated by a red LED and through the collective error output via Power Rail. For additional information, refer to the manual and www.pepperl-fuchs.com.

Application

- The device processes 2 input frequencies up to a max. of 1 kHz. The following functions are provided by the device:
- Frequency measurement with freely adjustable trip value monitoring for high and low alarm as well as for frequency current conversion (0/4 mA to 20 mA)
 - Slip monitoring: The slip is calculated from the 2 input frequencies at channel I and II. If the freely parameterisable trip value is exceeded, the respective output switches.
 - Rotation direction signalling: The rotation direction is evaluated from the 2 input signals with the same frequency and a phase shift of 90°. The corresponding outputs switch according to the direction of rotation.
 - The frequency monitoring can be used in combination with rotation direction signalling or slip monitoring.
 - Synchronisation monitor: The synchronisation monitor compares the pulse counts of the 2 inputs. If the measured difference in the pulses is greater than the programmed value the corresponding outputs are switching.
- The 2 electronic outputs serve to repeat the input signals.

Connection

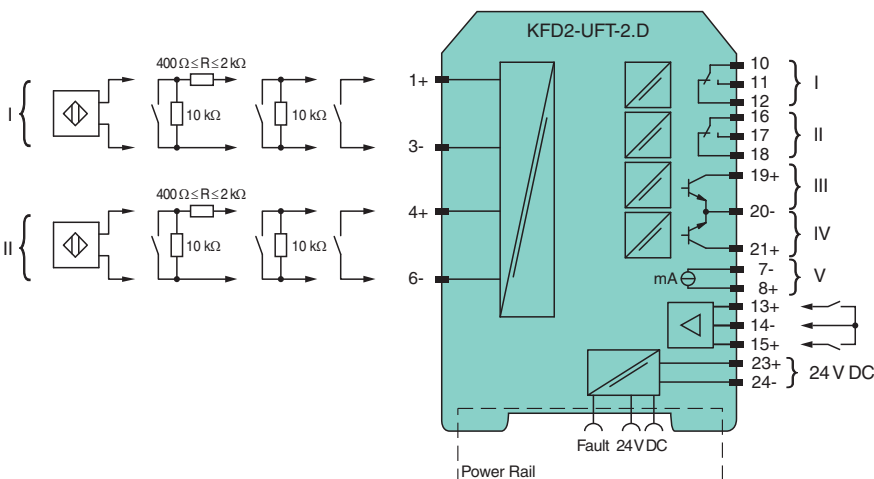

Release date: 2023-05-31 Date of issue: 2023-05-31 Filename: 231198_eng.pdf

Refer to "General Notes Relating to Pepperl+Fuchs Product Information".

Pepperl+Fuchs Group
www.pepperl-fuchs.com

USA: +1 330 486 0002
pa-info@us.pepperl-fuchs.com

Germany: +49 621 776 2222
pa-info@de.pepperl-fuchs.com

Singapore: +65 6779 9091
pa-info@sg.pepperl-fuchs.com

pf PEPPERL+FUCHS

Technical Data

General specifications		
Signal type	Digital Input	
Supply		
Connection	terminals 23+, 24- or power feed module/Power Rail	
Rated voltage	U_r	20 ... 30 V DC
Rated current	I_r	approx. 130 mA
Power dissipation	2.2 W	
Power consumption	2.5 W	
Interface		
Programming interface	programming socket	
Input		
Connection side	field side	
Connection	input I: terminals 1+, 3- input II: terminals 4+, 6- input III: terminals 13+, 14- (control input 1) input IV: terminals 15+, 14- (control input 2)	
Input I, II	2-wire sensor, sensor acc. to EN 60947-5-6 (NAMUR) or mechanical contact	
Open circuit voltage/short-circuit current	8.2 V / 10 mA	
Switching point/switching hysteresis	logic 1: > 2.5 mA ; logic 0: < 1.9 mA	
Pulse duration	min. 250 μ s , overlap on direction of rotation signal: \geq 125 μ s	
Input frequency	rotation direction monitoring 0.001 ... 1000 Hz slip monitoring 10 ... 1000 Hz	
Line fault detection	breakage $I \leq 0.15$ mA; short-circuit $I > 4$ mA	
Input III, IV		
Active/Passive	$I > 4$ mA (for min. 100 ms) / $I < 1.5$ mA	
Open circuit voltage/short-circuit current	18 V / 5 mA	
Output		
Connection side	control side	
Connection	output I: terminals 10, 11, 12 output II: terminals 16, 17, 18 output III: terminals 19+, 20- output IV: terminals 21+, 20- output V: terminals 7-, 8+	
Output I, II	signal, relay	
Contact loading	250 V AC / 2 A / $\cos \phi \geq 0.7$; 40 DC / 2 A	
Mechanical life	5 x 10 ⁷ switching cycles	
Energized/De-energized delay	approx. 20 ms / approx. 20 ms	
Output III and IV	signal , electronic output, passive	
Contact loading	40 V DC	
Signal level	1-signal: (L+) -2.5 V (50 mA, short-circuit/overload proof) 0-signal: blocked output (off-state current ≤ 10 μ A)	
Output V	analog	
Current range	0 ... 20 mA or 4 ... 20 mA	
Open loop voltage	max. 24 V DC	
Load	max. 650 Ω	
Fault signal	downscale $I \leq 3.6$ mA, upscale $I \geq 21.5$ mA (acc. NAMUR NE43)	
Collective error message	Power Rail	
Transfer characteristics		
Input I and II		
Measurement range	0.001 ... 1000 Hz	
Resolution	slip monitoring: 1% frequency measurement: 0,1% of measured value; but >0.001Hz	
Accuracy	slip monitoring: 1% frequency measurement: 0.5% of measured value; but >0.001Hz	
Measuring time	frequency measurement: < 100 ms	
Influence of ambient temperature	0.003 %/K (30 ppm)	
Output I, II		
Response delay	≤ 200 ms	
Output V		

Release date: 2023-05-31 Date of issue: 2023-05-31 Filename: 231198_eng.pdf

Refer to "General Notes Relating to Pepperl+Fuchs Product Information".

Pepperl+Fuchs Group
www.pepperl-fuchs.comUSA: +1 330 486 0002
pa-info@us.pepperl-fuchs.comGermany: +49 621 776 2222
pa-info@de.pepperl-fuchs.comSingapore: +65 6779 9091
pa-info@sg.pepperl-fuchs.com
 PEPPERL+FUCHS







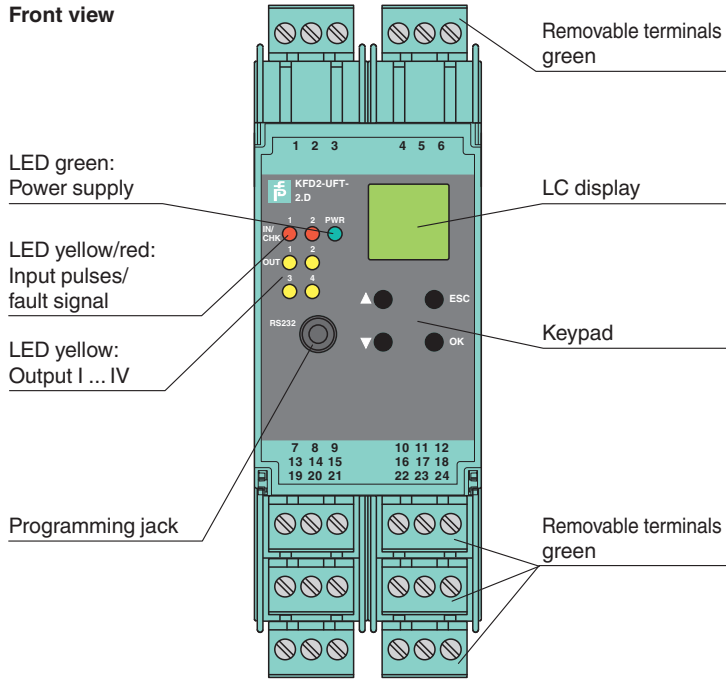

Technical Data

Resolution	< 10 μ A
Accuracy	< 30 μ A
Influence of ambient temperature	0.005 %/K (50 ppm)
Galvanic isolation	
Input I, II/other circuits	reinforced insulation according to IEC/EN 61010-1, rated insulation voltage 300 V _{eff}
Input III, IV/power supply and collective error	functional insulation acc. to IEC 62103, rated insulation voltage 50 V _{eff}
Output I, II/other circuits	reinforced insulation according to IEC/EN 61010-1, rated insulation voltage 300 V _{eff}
Mutual output I, II, III	reinforced insulation according to IEC/EN 61010-1, rated insulation voltage 300 V _{eff}
Mutual output I, II, IV	reinforced insulation according to IEC/EN 61010-1, rated insulation voltage 300 V _{eff}
Output III, IV/power supply and collective error	basic insulation according to IEC/EN 61010-1, rated insulation voltage 50 V _{eff}
Output III, IV/input III, IV	basic insulation according to IEC/EN 61010-1, rated insulation voltage 50 V _{eff}
Output III, IV/V	basic insulation according to IEC/EN 61010-1, rated insulation voltage 50 V _{eff}
Output V/power supply and collective error	functional insulation acc. to IEC 62103, rated insulation voltage 50 V _{eff}
Interface/power supply and collective error	functional insulation acc. to IEC 62103, rated insulation voltage 50 V _{eff}
Interface/output III, IV	basic insulation according to IEC/EN 61010-1, rated insulation voltage 50 V _{eff}
Indicators/settings	
Display elements	LEDs , display
Control elements	Control panel
Configuration	via operating buttons via PACTware
Labeling	space for labeling at the front
Directive conformity	
Electromagnetic compatibility	
Directive 2014/30/EU	EN 61326-1:2013 (industrial locations)
Low voltage	
Directive 2014/35/EU	EN 61010-1:2010
Conformity	
Electromagnetic compatibility	NE 21:2006
Degree of protection	IEC 60529:2001
Input	EN 60947-5-6:2000
Ambient conditions	
Ambient temperature	-20 ... 60 °C (-4 ... 140 °F)
Mechanical specifications	
Degree of protection	IP20
Connection	screw terminals
Mass	300 g
Dimensions	40 x 119 x 115 mm (1.6 x 4.7 x 4.5 inch) (W x H x D) , housing type C2
Mounting	on 35 mm DIN mounting rail acc. to EN 60715:2001
International approvals	
UL approval	E223772
General information	
Supplementary information	Observe the certificates, declarations of conformity, instruction manuals, and manuals where applicable. For information see www.pepperl-fuchs.com .

Assembly



Matching System Components

	DTM Interface Technology	Device type manager (DTM) for interface technology
	PACTware 5.0	FDT Framework
	K-ADP-USB	Programming adapter with USB interface
	KFD2-EB2	Power Feed Module
	UPR-03	Universal Power Rail with end caps and cover, 3 conductors, length: 2 m
	UPR-03-M	Universal Power Rail with end caps and cover, 3 conductors, length: 1,6 m
	UPR-03-S	Universal Power Rail with end caps and cover, 3 conductors, length: 0.8 m
	K-DUCT-GY	Profile rail, wiring comb field side, gray
	K-DUCT-GY-UPR-03	Profile rail with UPR-03-* insert, 3 conductors, wiring comb field side, gray

Accessories

	K-250R	Measuring resistor
---	---------------	--------------------

Release date: 2023-05-31 Date of issue: 2023-05-31 Filename: 231198_eng.pdf

Refer to "General Notes Relating to Pepperl+Fuchs Product Information".

Pepperl+Fuchs Group
www.pepperl-fuchs.com



USA: +1 330 486 0002
pa-info@us.pepperl-fuchs.com

Germany: +49 621 776 2222
pa-info@de.pepperl-fuchs.com

Singapore: +65 6779 9091
pa-info@sg.pepperl-fuchs.com

 **PEPPERL+FUCHS**

Accessories

	K-500R0%1	Measuring resistor
	KF-ST-5GN	Terminal block for KF modules, 3-pin screw terminal, green
	KF-CP	Red coding pins, packaging unit: 20 x 6

Characteristic Curve

Maximum Switching Power of Output Contacts

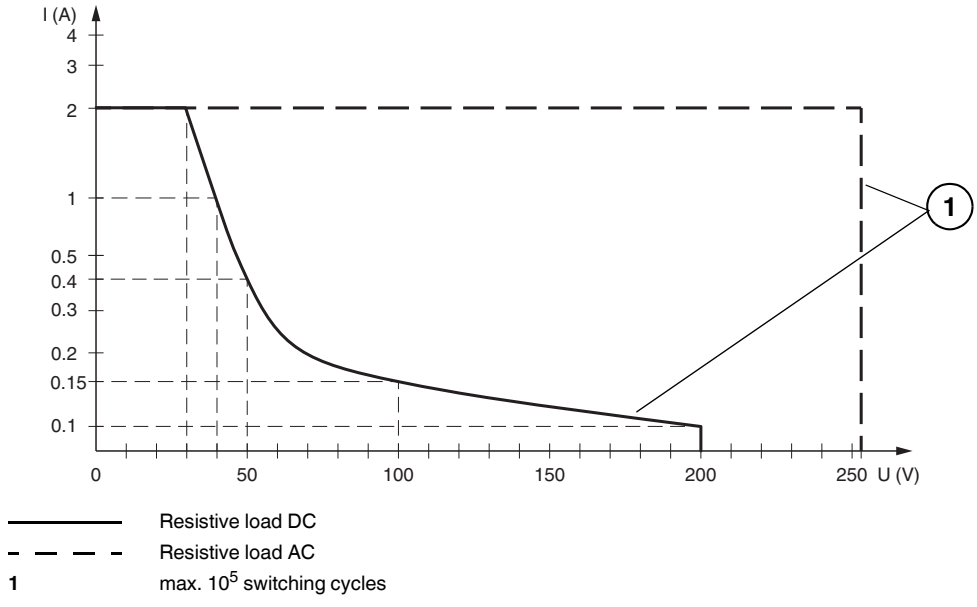

Release date: 2023-05-31 Date of issue: 2023-05-31 Filename: 231198_eng.pdf

Refer to "General Notes Relating to Pepperl+Fuchs Product Information".

Pepperl+Fuchs Group
www.pepperl-fuchs.com

USA: +1 330 486 0002
pa-info@us.pepperl-fuchs.com

Germany: +49 621 776 2222
pa-info@de.pepperl-fuchs.com

Singapore: +65 6779 9091
pa-info@sg.pepperl-fuchs.com

PEPPERL+FUCHS