



## Inductive sensor NBN3-F31K2-E8-B13-S

- Direct mounting on standard actuators
- Weatherproof housing for outdoor applications
- Temperature range -40 ... 167 °F (-40°C to 75°C)
- LED for power on
- LEDs for switching state of sensor and solenoid valve
- Plug-in terminals



### Installation

The connections to this sensor are sealed with stopping plugs to protect against dirt and moisture. If not all of the connections are used in your application, then seal the remaining stopping plugs on the sensor permanently or check during initial installation and when performing regular maintenance work that the stopping plugs are secure and impermeable. If necessary, tighten the stopping plugs to a torque of 1 Nm.

### Dimensions

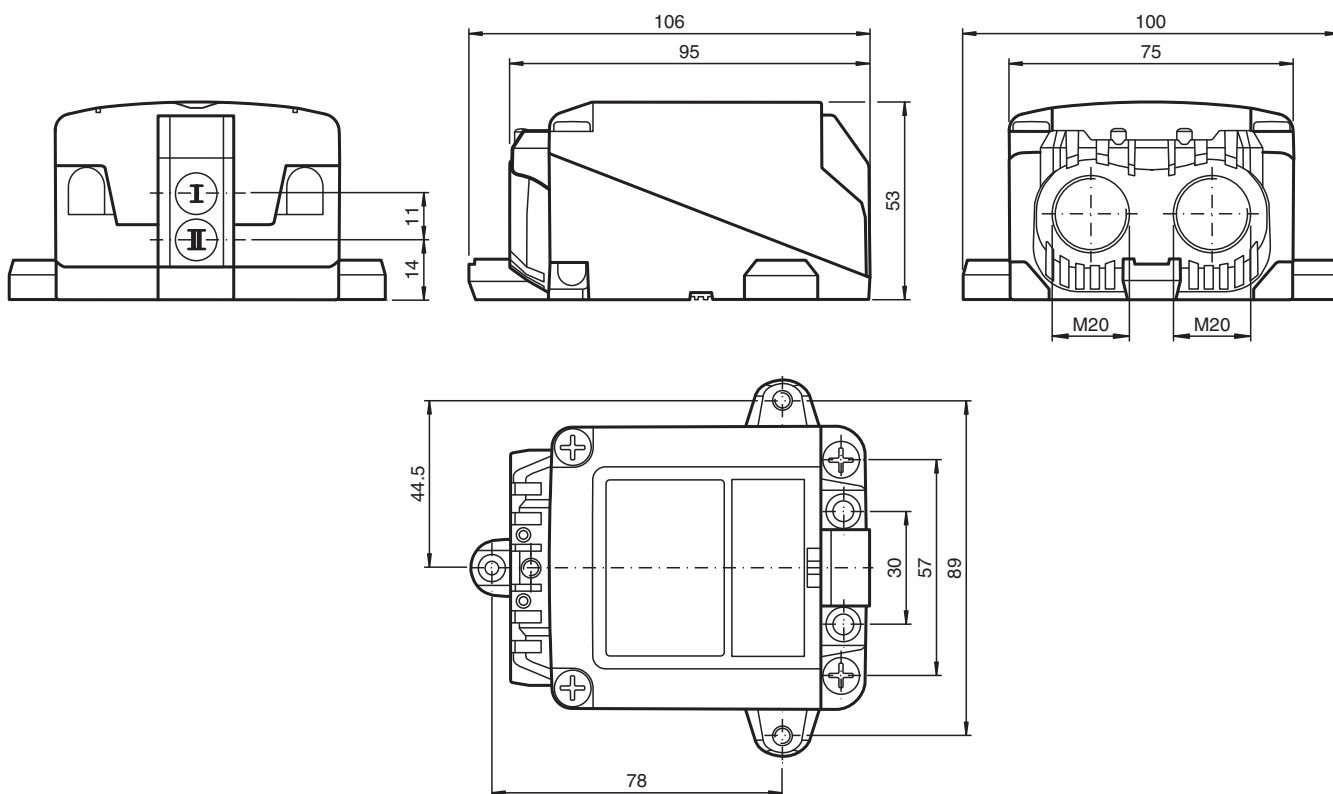

Release date: 2023-05-09 Date of issue: 2023-05-09 Filename: 235086\_eng.pdf

Refer to "General Notes Relating to Pepperl+Fuchs Product Information".

Pepperl+Fuchs Group  
www.pepperl-fuchs.com

USA: +1 330 486 0001  
fa-info@us.pepperl-fuchs.com

Germany: +49 621 776 1111  
fa-info@de.pepperl-fuchs.com

Singapore: +65 6779 9091  
fa-info@sg.pepperl-fuchs.com

**pf** PEPPERL+FUCHS

## Technical Data



General specifications		
Switching function		2 x normally open (NO)
Output type		PNP
Rated operating distance	$s_n$	2.5 mm
Installation		for non-flush mounting
Output polarity		DC
Assured operating distance	$s_a$	0 ... 2.05 mm
Output type		4-wire
Nominal ratings		
Operating voltage	$U_B$	10 ... 30 V
Switching frequency	$f$	0 ... 100 Hz
Hysteresis	$H$	typ. 5 %
Reverse polarity protection		all connections
Short-circuit protection		pulsing
Voltage drop	$U_d$	$\leq 3$ V
Operating current	$I_L$	0 ... 100 mA
Off-state current	$I_r$	0 ... 0.5 mA typ. 0.1 $\mu$ A
No-load supply current	$I_0$	$\leq 25$ mA
Operating voltage indicator		LED, green
Switching state indicator		LED, yellow
Valve status indicator		LED, yellow
Functional safety related parameters		
MTTF <sub>d</sub>		490 a
Mission Time (T <sub>M</sub> )		20 a
Diagnostic Coverage (DC)		0 %
Valve circuit		
Voltage		max. 32 V DC
Current		max. 240 mA
Short-circuit protection		no
Reverse polarity protection		yes, with reversed output LED is out of function, therefore more power for solenoid valve
Compliance with standards and directives		
Standard conformity		
Standards		EN 60947-5-2:2007 EN 60947-5-2/A1:2012 IEC 60947-5-2:2007 IEC 60947-5-2 AMD 1:2012 VDI / VDE 3845
Ambient conditions		
Ambient temperature		-40 ... 75 °C (-40 ... 167 °F)
Storage temperature		-40 ... 85 °C (-40 ... 185 °F)
Mechanical specifications		
Connection (system side)		screw terminal , M20 x 1.5 cable gland
Core cross section (system side)		1.5/2.5 mm <sup>2</sup> flexible/rigid
Housing material		rugged, translucent polycarbonate (PC) optimised for outdoor use
Housing base		PC
Degree of protection		IP66 / IP68 / IP69
Tightening torque, fastening screws		4 Nm ... 5 Nm
Tightening torque, housing screws		$\leq 2$ Nm
Tightening torque of cover screws		1.5 Nm
Tightening torque, cable gland		M20 x 1.5 ; max. 7 Nm
Tightening torque, stopping plug		1 Nm

Release date: 2023-05-09 Date of issue: 2023-05-09 Filename: 235086\_eng.pdf

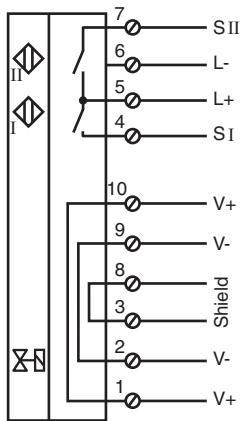

## Connection



## Matching System Components

	<b>BT115A</b>	Activator for F31 series
	<b>BT115X</b>	Activator for F31 series

## Accessories

	<b>BT65-F31K2-RG-EN</b>	Activator for F31K2 series
	<b>BT65A</b>	Activator for F31 series
	<b>BT65X</b>	Activator for F31 series

Release date: 2023-05-09 Date of issue: 2023-05-09 Filename: 235086\_eng.pdf