

# Connection cable

## V1-W-BK0,6M-PUR-A-V1-W



- Improved resistance to weld spatter
- Suitable for drag chains and abrasion resistant
- Suitable for robotic applications / torsion resistant
- Degree of protection IP68 / IP69
- Free of paint wetting interfering substances
- Resistant to microbes and hydrolysis
- UL listed for USA and Canada
- Halogen-free
- Specific design protects against loosening and inaccurate installation

Cordset M12 socket angled to M12 plug angled A-coded, 4-pin, PUR cable weld spatter resistant black, UL approved, drag chain suitable, torsion resistant



### Dimensions

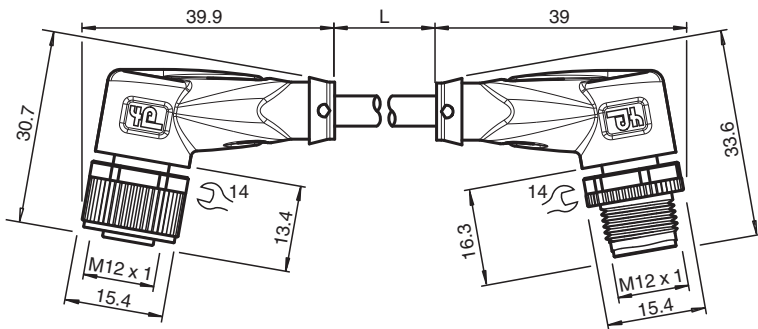

### Technical Data

#### General specifications

|                   |                  |
|-------------------|------------------|
| Connector 1       |                  |
| Connection        | socket           |
| Construction type | M12              |
| Style             | angled           |
| Locking           | screw connection |
| Number of pins    | 4                |
| Coding            | A-coded          |
| Connector 2       |                  |
| Connection        | plug             |
| Construction type | M12              |
| Style             | angled           |
| Locking           | screw connection |
| Number of pins    | 4                |
| Coding            | A-coded          |

#### Electrical specifications

|                   |                |                  |
|-------------------|----------------|------------------|
| Operating voltage | U <sub>B</sub> | max. 250 V AC/DC |
| Operating current | I <sub>B</sub> | max. 4 A         |

#### Conformity

|                      |          |
|----------------------|----------|
| Degree of protection | EN 60529 |
|----------------------|----------|

Release date: 2023-07-13 Date of issue: 2023-07-13 Filename: 240777-100002\_eng.pdf

Refer to "General Notes Relating to Pepperl+Fuchs Product Information".

Pepperl+Fuchs Group  
www.pepperl-fuchs.com

USA: +1 330 486 0001  
fa-info@us.pepperl-fuchs.com

Germany: +49 621 776 1111  
fa-info@de.pepperl-fuchs.com

Singapore: +65 6779 9091  
fa-info@sg.pepperl-fuchs.com

**PF** PEPPERL+FUCHS

## Technical Data

|                                   |   |   |
|-----------------------------------|---|---|
| Plug connection                   |   | connector M12 x 1 : IEC 61076-2-101                             |
| Flammability                      |   | UL 1581; DIN EN 60332-2-2                                       |
| Halogen-free                      |   | DIN VDE 0472-815<br>IEC 60754-1                                 |
| Microbial resistance              |   | DIN EN 50525-2-21 / DIN VDE 0282-10                             |
| Hydrolysis resistance             |   | DIN EN 50525-2-21   |
| <b>Approvals and certificates</b> |   |   |
| UL approval                       |   | AWM STYLE 20549 AWM I/II A/B 80°C 300V FT2 (cable)              |
| UL File Number                    |   | E231213   |
| <b>Ambient conditions</b>         |   |   |
| Ambient temperature               |   |   |
| Plug connector                    |   | -40 ... 90 °C (-40 ... 194 °F)                                  |
| Cable, fixed                      |   | -40 ... 80 °C (-40 ... 176 °F)                                  |
| Cable, flexing                    |   | -25 ... 80 °C (-13 ... 176 °F)                                  |
| Pollution degree                  |   | 3   |
| <b>Mechanical specifications</b>  |   |   |
| Plug connector                    |   |   |
| Tightening torque                 |   | 0.6 Nm  |
| Loosening protection              |   | available   |
| Tool installation                 |   | straight knurling and hexagon nut SW = 14 mm                    |
| Mating cycles                     |   | min. 100  |
| Degree of protection              |   | IP68 / IP69   |
| Cable                             |   | according to IEC/EN 60228 (DIN VDE 0295) class 6                |
| Sheath diameter                   |   | 4.3 mm  |
| Bending radius                    |   | > 10 x cable diameter, moving<br>> 5 x cable diameter, fixed    |
| Sheath stripping force            |   | max. 80 N / 300 mm  |
| Sheath color                      |   | black (similar to RAL 9005)                                     |
| Number of cores                   |   | 4   |
| Core cross section                |   | 0.34 mm <sup>2</sup>  |
| Cores color                       |   | Core 1: brown<br>Core 2: white<br>Core 3: blue<br>Core 4: black |
| Core construction                 |   | 42 x 0.1 mm Ø   |
| Length                            | L | 0.6 m   |
| Cable code                        |   | Li F 9Y 11Y 4 x 0,34  |
| Drag chain suitability            |   |   |
| Drag chain cycles                 |   | min. 5000000  |
| Motion velocity                   |   | max. 3.3 m/s  |
| Traverse distance                 |   | max. 5 m  |
| Acceleration                      |   | max. 5 m/s <sup>2</sup>   |
| Torsion cycles                    |   | min. 1000000  |
| Torsional stress                  |   | ± 180 °/m   |
| <b>Material</b>                   |   |   |
| PWIS free                         |   | yes   |
| Halogen-free                      |   | yes   |
| Plug connector                    |   |   |
| Screw connection                  |   | Zinc diecast, nickel-plated                                     |
| Body                              |   | TPU, black  |
| Seal                              |   | FKM   |
| Contact surface                   |   | gold plated (Au)  |
| Flammability                      |   | V-2   |
| Cable                             |   |   |
| Sheathing                         |   | PUR based on polyether  |

Release date: 2023-07-13 Date of issue: 2023-07-13 Filename: 240777-100002\_eng.pdf

Refer to "General Notes Relating to Pepperl+Fuchs Product Information".

Pepperl+Fuchs Group  
www.pepperl-fuchs.comUSA: +1 330 486 0001  
fa-info@us.pepperl-fuchs.comGermany: +49 621 776 1111  
fa-info@de.pepperl-fuchs.comSingapore: +65 6779 9091  
fa-info@sg.pepperl-fuchs.com

**PEPPERL+FUCHS**





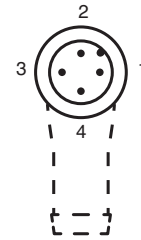
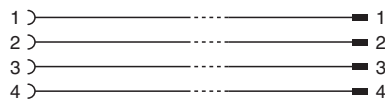
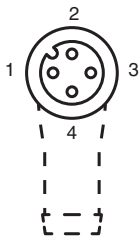

### Technical Data

|                              |      |
|------------------------------|------|
| Core insulation              | PP   |
| Weld spatter resistance      | yes  |
| Chemical resistance          | good |
| Oil resistance               | yes  |
| Cooling lubricant resistance | yes  |
| Microbial resistance         | yes  |
| Hydrolysis resistance        | yes  |
| Flammability                 | FT2  |

### Connection



### Accessories

|   |                              |  |
|---|------------------------------|--|
|   | <b>MH V1-SCREWDRIVER</b>     | Torque screwdriver (0.6 Nm)                      |
|  | <b>MH V1-BIT M12</b>         | plug-in cap M12                                  |
|  | <b>V1/V3-LABELHOLDER</b>     | Label holder                                     |
|  | <b>V1/V3-LABEL</b>           | Label plate                                      |
|  | <b>MH V1-Holder</b>          | Modular universal holder for M12 connectors      |
|  | <b>V1-CLIP</b>               | Unlocking protector for M12 connector            |
|  | <b>V1-MARKING-RING-COLOR</b> | Marking rings for M12 connectors, various colors |

Release date: 2023-07-13 Date of issue: 2023-07-13 Filename: 240777-100002\_eng.pdf