

Connection cable

V1-G-OR3M-POC-V1-W



- Welding-bead resistant
- Suitable for robotic applications / torsion resistant
- Degree of protection IP68 / IP69
- Free of paint wetting interfering substances
- Ozone resistant
- Hydrolysis resistant
- Oil resistant
- Halogen-free
- Specific design protects against loosening and inaccurate installation

Cordset M12 socket straight to M12 plug angled A-coded, 4-pin, POC cable welding-bead resistant orange, suitable for robotic applications, torsion resistant, oil resistant, molecularly cross-linked



Dimensions

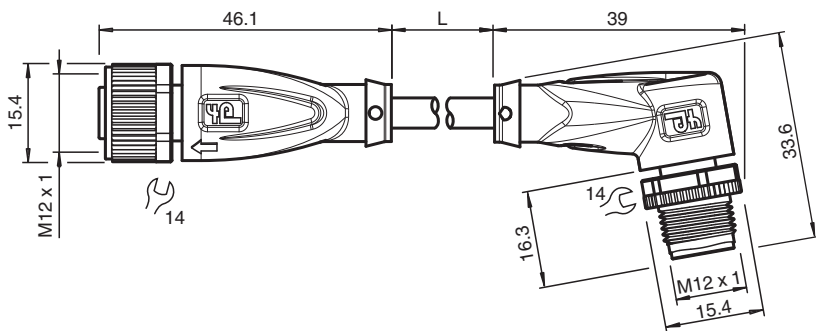

Technical Data

General specifications

| | | |
|--------------------|--|------------------|
| Connector 1 | | |
| Connection | | socket |
| Construction type | | M12 |
| Style | | straight |
| Locking | | screw connection |
| Number of pins | | 4 |
| Coding | | A-coded |
| Connector 2 | | |
| Connection | | plug |
| Construction type | | M12 |
| Style | | angled |
| Locking | | screw connection |
| Number of pins | | 4 |
| Coding | | A-coded |

Electrical specifications

| | | |
|-------------------|-------|------------------|
| Operating voltage | U_B | max. 250 V AC/DC |
| Operating current | I_B | max. 4 A |

Conformity

| | | |
|----------------------|--|----------|
| Degree of protection | | EN 60529 |
|----------------------|--|----------|

Release date: 2023-07-13 Date of issue: 2023-07-13 Filename: 240778-100028_eng.pdf

Refer to "General Notes Relating to Pepperl+Fuchs Product Information".

Pepperl+Fuchs Group
www.pepperl-fuchs.com

USA: +1 330 486 0001
fa-info@us.pepperl-fuchs.com

Germany: +49 621 776 1111
fa-info@de.pepperl-fuchs.com

Singapore: +65 6779 9091
fa-info@sg.pepperl-fuchs.com

PF PEPPERL+FUCHS

Technical Data

| | | |
|----------------------------------|---|---|
| Plug connection | | connector M12 x 1 : IEC 61076-2-101 |
| Flammability | | IEC 60332-1-2 , ISO 14572 , ISO 6722 |
| Halogen-free | | IEC 60754-2 |
| Hydrolysis resistance | | ISO 6722 |
| Oil resistance | | ISO 14572 |
| Ambient conditions | | |
| Ambient temperature | | |
| Plug connector | | -40 ... 90 °C (-40 ... 194 °F) |
| Cable, fixed | | -40 ... 120 °C (-40 ... 248 °F) for 20000 h -40 ... 150 °C (-40 ... 302 °F) for 3000 h |
| Cable, flexing | | -15 ... 120 °C (5 ... 248 °F) for 20000 h -15 ... 150 °C (5 ... 302 °F) for 3000 h |
| Pollution degree | | 3 |
| Mechanical specifications | | |
| Plug connector | | |
| Tightening torque | | 0.6 Nm |
| Loosening protection | | available |
| Tool installation | | straight knurling and hexagon nut SW = 14 mm |
| Mating cycles | | min. 100 |
| Degree of protection | | IP68 / IP69 |
| Cable | | according to IEC/EN 60228 (DIN VDE 0295) class 5 |
| Sheath diameter | | 4.8 mm |
| Bending radius | | > 10 x cable diameter, moving > 10 x cable diameter, fixed |
| Sheath stripping force | | max. 50 N / 300 mm |
| Sheath color | | orange (similar to RAL 2003) |
| Number of cores | | 4 |
| Core cross section | | 0.34 mm ² |
| Cores color | | Core 1: brown Core 2: white Core 3: blue Core 4: black |
| Core construction | | 19 x 0.16 mm Ø |
| Length | L | 3 m |
| Cable code | | Li 7Y 41X 4 x 0,34 |
| Drag chain suitability | | |
| Torsion cycles | | min. 300000 |
| Torsional stress | | ± 360 °/30 cm |
| Material | | |
| PWIS free | | yes |
| Halogen-free | | yes |
| Plug connector | | |
| Screw connection | | Zinc diecast, nickel-plated |
| Body | | TPU, black |
| Seal | | FKM |
| Contact surface | | gold plated (Au) |
| Flammability | | V-2 |
| Cable | | |
| Sheathing | | POC |
| Core insulation | | ETFE |
| Welding-bead resistance | | yes |
| Weld spatter resistance | | yes |
| Oil resistance | | yes |
| Hydrolysis resistance | | yes |
| Flammability | | flame-resistant |

Release date: 2023-07-13 Date of issue: 2023-07-13 Filename: 240778-100028_eng.pdf

Refer to "General Notes Relating to Pepperl+Fuchs Product Information".

Pepperl+Fuchs Group
www.pepperl-fuchs.com

USA: +1 330 486 0001
fa-info@us.pepperl-fuchs.com

Germany: +49 621 776 1111
fa-info@de.pepperl-fuchs.com

Singapore: +65 6779 9091
fa-info@sg.pepperl-fuchs.com

 PEPPERL+FUCHS





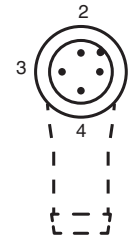
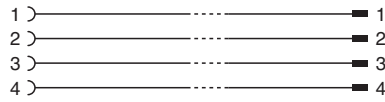
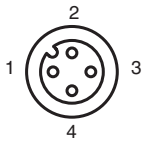

Technical Data

Molecularly cross-linked yes

Connection



Accessories

| | | |
|---|------------------------------|--|
|  | MH V1-SCREWDRIVER | Torque screwdriver (0.6 Nm) |
|  | MH V1-BIT M12 | plug-in cap M12 |
|  | V1/V3-LABELHOLDER | Label holder |
|  | V1/V3-LABEL | Label plate |
|  | MH V1-Holder | Modular universal holder for M12 connectors |
|  | V1-CLIP | Unlocking protector for M12 connector |
|  | V1-MARKING-RING-COLOR | Marking rings for M12 connectors, various colors |

Release date: 2023-07-13 Date of issue: 2023-07-13 Filename: 240778-100028_eng.pdf