

Connection cable

V31-WM-BK15M-PVC-U-V1-G



- Degree of protection IP68
- UL listed for USA and Canada
- Specific design protects against loosening and inaccurate installation

Cordset M8 socket angled to M12 plug straight A-coded, 4-pin, PVC cable black, UL approved



Dimensions

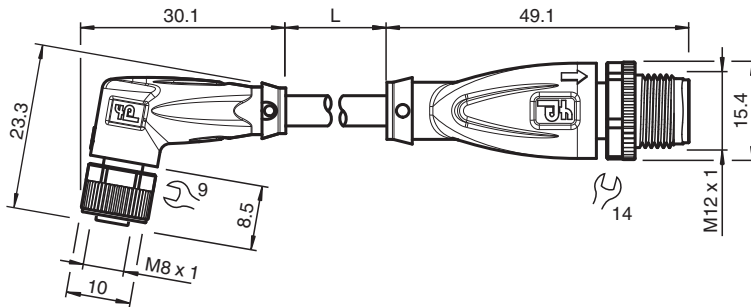

Technical Data

General specifications

| | | |
|-------------------|--|------------------|
| Connector 1 | | |
| Connection | | socket |
| Construction type | | M8 |
| Style | | angled |
| Locking | | screw connection |
| Number of pins | | 4 |
| Coding | | A-coded |
| Connector 2 | | |
| Connection | | plug |
| Construction type | | M12 |
| Style | | straight |
| Locking | | screw connection |
| Number of pins | | 4 |
| Coding | | A-coded |

Electrical specifications

| | | |
|-------------------|-------|-----------------|
| Operating voltage | U_B | max. 30 V AC/DC |
| Operating current | I_B | max. 3 A |

Conformity

| | | |
|----------------------|--|---|
| Degree of protection | | EN 60529 |
| Plug connection | | connector M8 x 1 : IEC 61076-2-104 connector M12 x 1 : IEC 61076-2-101 |

Release date: 2023-06-29 Date of issue: 2023-06-29 Filename: 240798-0006_eng.pdf

Refer to "General Notes Relating to Pepperl+Fuchs Product Information".

Pepperl+Fuchs Group
www.pepperl-fuchs.com

USA: +1 330 486 0001
fa-info@us.pepperl-fuchs.com

Germany: +49 621 776 1111
fa-info@de.pepperl-fuchs.com

Singapore: +65 6779 9091
fa-info@sg.pepperl-fuchs.com

PEPPERL+FUCHS

Technical Data

| | | |
|-----------------------------------|---|------|
| Flammability | UL 1581 , IEC 60332-1-2 | |
| Approvals and certificates | | |
| UL approval | AWM STYLE 2095 AWM I/II A/B 80°C 300V FT1 (cable) | |
| UL File Number | E231213 | |
| Ambient conditions | | |
| Ambient temperature | | |
| Plug connector | -40 ... 90 °C (-40 ... 194 °F) | |
| Cable, fixed | -25 ... 80 °C (-13 ... 176 °F) | |
| Cable, flexing | -5 ... 80 °C (23 ... 176 °F) | |
| Pollution degree | 3 | |
| Mechanical specifications | | |
| Connector 1 | | |
| Tightening torque | 0.4 Nm | |
| Loosening protection | available | |
| Tool installation | straight knurling and hexagon nut SW = 9 mm | |
| Mating cycles | min. 100 | |
| Degree of protection | IP68 | |
| Connector 2 | | |
| Tightening torque | 0.6 Nm | |
| Loosening protection | available | |
| Tool installation | straight knurling and hexagon nut SW = 14 mm | |
| Mating cycles | min. 100 | |
| Degree of protection | IP68 / IP69 | |
| Cable | | |
| Sheath diameter | 4.3 mm | |
| Bending radius | > 15 x cable diameter, moving > 5 x cable diameter, fixed | |
| Sheath stripping force | max. 50 N / 300 mm | |
| Sheath color | black (similar to RAL 9005) | |
| Number of cores | 4 | |
| Core cross section | 0.34 mm ² | |
| Cores color | Core 1: brown Core 2: white Core 3: blue Core 4: black | |
| Core construction | 19 x 0.15 mm Ø | |
| Length | L | 15 m |
| Cable code | Li YY 4 x 0,34 | |
| Material | | |
| Plug connector | | |
| Screw connection | Zinc diecast, nickel-plated | |
| Body | TPU, black | |
| Seal | FKM | |
| Contact surface | gold plated (Au) | |
| Flammability | V-2 | |
| Cable | | |
| Sheathing | PVC | |
| Core insulation | PVC | |
| Flammability | FT1 | |

Release date: 2023-06-29 Date of issue: 2023-06-29 Filename: 240798-0006_eng.pdf

Refer to "General Notes Relating to Pepperl+Fuchs Product Information".







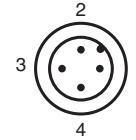
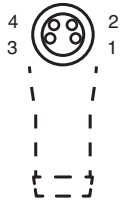



Pepperl+Fuchs Group
www.pepperl-fuchs.comUSA: +1 330 486 0001
fa-info@us.pepperl-fuchs.comGermany: +49 621 776 1111
fa-info@de.pepperl-fuchs.comSingapore: +65 6779 9091
fa-info@sg.pepperl-fuchs.com

PEPPERL+FUCHS

Connection



Accessories

| | | |
|---|------------------------------|--|
|  | MH V1-SCREWDRIVER | Torque screwdriver (0.6 Nm) |
|  | MH V1-BIT M12 | plug-in cap M12 |
|  | MH V1-Holder | Modular universal holder for M12 connectors |
|  | V1-CLIP | Unlocking protector for M12 connector |
|  | V1-MARKING-RING-COLOR | Marking rings for M12 connectors, various colors |
|  | V1/V3-LABELHOLDER | Label holder |
|  | V1/V3-LABEL | Label plate |
|  | MH V3-SCREWDRIVER | Torque screwdriver (0.4 Nm) |
|  | MH V3-BIT M8 | plug-in cap for M8 |
|  | MH V3-Holder | Modular universal holder for M8 connectors |

Release date: 2023-06-29 Date of issue: 2023-06-29 Filename: 240798-0006_eng.pdf