

Female cordset

V3-WM-E2-BK2M-PVC-U



- Built-in LED, as operating and function indicator
- Degree of protection IP68
- UL listed for USA and Canada
- Specific design protects against loosening and inaccurate installation

Female cordset single-ended M8 angled A-coded, LED 3-pin, PVC cable black, UL approved



Dimensions

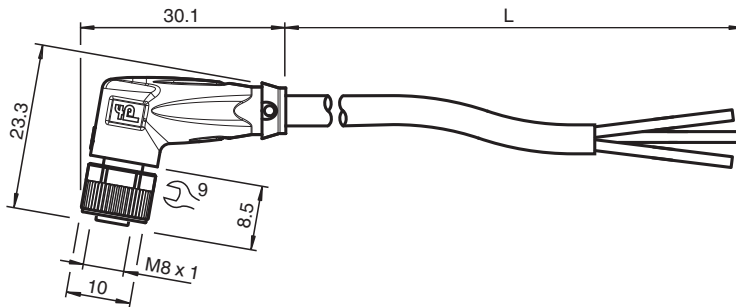

Technical Data

General specifications

Connector 1		
Connection		socket
Construction type		M8
Style		angled
Locking		screw connection
Number of pins		3
Coding		A-coded
Connector 2		
Connection		cable end

Indicators/operating means

LED green		Operating display
LED yellow		Functional display pin 4

Electrical specifications

Operating voltage	U_B	max. 24 V DC -20 % / +25 %
Operating current	I_B	max. 3 A

Conformity

Degree of protection		EN 60529
Plug connection		connector M8 x 1 : IEC 61076-2-104
Flammability		UL 1581 , IEC 60332-1-2

Approvals and certificates

UL approval		AWM STYLE 2095 AWM I/II A/B 80°C 300V FT1 (cable)
-------------	--	---

Release date: 2023-09-04 Date of issue: 2023-09-04 Filename: 240802-0004_eng.pdf

Refer to "General Notes Relating to Pepperl+Fuchs Product Information".

Pepperl+Fuchs Group
www.pepperl-fuchs.com

USA: +1 330 486 0001
fa-info@us.pepperl-fuchs.com

Germany: +49 621 776 1111
fa-info@de.pepperl-fuchs.com

Singapore: +65 6779 9091
fa-info@sg.pepperl-fuchs.com

PF PEPPERL+FUCHS



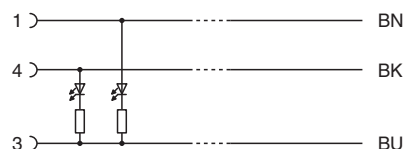

Technical Data

UL File Number	E231213
Ambient conditions	
Ambient temperature	
Plug connector	-40 ... 90 °C (-40 ... 194 °F)
Cable, fixed	-25 ... 80 °C (-13 ... 176 °F)
Cable, flexing	-5 ... 80 °C (23 ... 176 °F)
Pollution degree	3
Mechanical specifications	
Plug connector	
Tightening torque	0.4 Nm
Loosening protection	available
Tool installation	straight knurling and hexagon nut SW = 9 mm
Mating cycles	min. 100
Degree of protection	IP68
Cable	according to IEC/EN 60228 (DIN VDE 0295) class 5
Sheath diameter	4.3 mm
Bending radius	> 15 x cable diameter, moving > 5 x cable diameter, fixed
Sheath stripping force	max. 50 N / 300 mm
Sheath color	black (similar to RAL 9005)
Number of cores	3
Core cross section	0.34 mm ²
Cores color	Core 1: brown Core 3: blue Core 4: black
Core construction	19 x 0.15 mm Ø
Length	L 2 m
Cable code	Li YY 3 x 0,34
Material	
Plug connector	
Screw connection	Zinc diecast, nickel-plated
Body	TPU, transparent
Seal	FKM
Contact surface	gold plated (Au)
Flammability	V-2
Cable	
Sheathing	PVC
Core insulation	PVC
Flammability	FT1

Connection



Accessories

	MH V3-SCREWDRIVER	Torque screwdriver (0.4 Nm)
	MH V3-BIT M8	plug-in cap for M8
	V1/V3-LABELHOLDER	Label holder
	V1/V3-LABEL	Label plate
	MH V3-Holder	Modular universal holder for M8 connectors