

Connection cable

V3-WM-E2-1,5M-PUR-V3-GM



- Built-in LED, as operating and function indicator
- Degree of protection IP68
- Resistant to microbes and hydrolysis
- Halogen-free
- Specific design protects against loosening and inaccurate installation

Cordset M8 socket angled A-coded LED 3-pin to M8 plug straight A-coded 3-pin, PUR cable grey



Dimensions

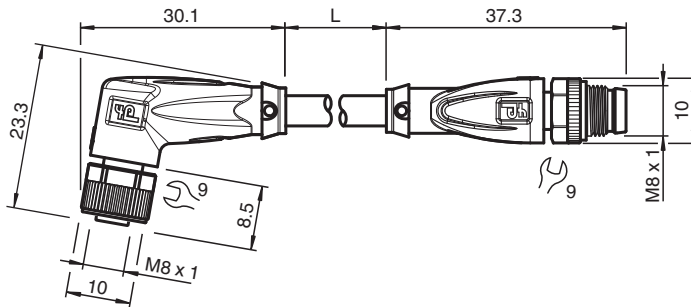

Technical Data

General specifications

Connector 1	
Connection	socket
Construction type	M8
Style	angled
Locking	screw connection
Number of pins	3
Coding	A-coded
Connector 2	
Connection	plug
Construction type	M8
Style	straight
Locking	screw connection
Number of pins	3
Coding	A-coded

Indicators/operating means

LED green	Operating display
LED yellow	Functional display pin 4

Electrical specifications

Operating voltage	U_B	max. 24 V DC -20 % / +25 %
Operating current	I_B	max. 3 A

Conformity

Release date: 2023-06-20 Date of issue: 2023-06-20 Filename: 240819-0002_eng.pdf

Refer to "General Notes Relating to Pepperl+Fuchs Product Information".

Pepperl+Fuchs Group
www.pepperl-fuchs.com

USA: +1 330 486 0001
fa-info@us.pepperl-fuchs.com

Germany: +49 621 776 1111
fa-info@de.pepperl-fuchs.com

Singapore: +65 6779 9091
fa-info@sg.pepperl-fuchs.com

PF PEPPERL+FUCHS

Technical Data

Degree of protection		EN 60529
Plug connection		connector M8 x 1 : IEC 61076-2-104
Halogen-free		IEC 60754-1
Ambient conditions		
Ambient temperature		
Plug connector		-40 ... 90 °C (-40 ... 194 °F)
Cable, fixed		-40 ... 80 °C (-40 ... 176 °F)
Cable, flexing		-20 ... 80 °C (-4 ... 176 °F)
Pollution degree		3
Mechanical specifications		
Plug connector		
Tightening torque		0.4 Nm
Loosening protection		available
Tool installation		straight knurling and hexagon nut SW = 9 mm
Mating cycles		min. 100
Degree of protection		IP68
Cable		according to IEC/EN 60228 (DIN VDE 0295) class 5
Sheath diameter		4.3 mm
Bending radius		> 15 x cable diameter, moving > 8 x cable diameter, fixed
Sheath stripping force		max. 80 N / 500 mm
Sheath color		grey (similar to RAL 7001)
Number of cores		3
Core cross section		0.25 mm ²
Cores color		Core 1: brown Core 3: blue Core 4: black
Core construction		14 x 0.15 mm Ø
Length	L	1.5 m
Cable code		Li 9Y 11Y 3 x 0,25
Drag chain suitability		
Drag chain cycles		max. 50 / day
Motion velocity		max. 0.3 m/s
Material		
Halogen-free		yes
Plug connector		
Screw connection		Zinc diecast, nickel-plated
Body		TPU, transparent/black
Seal		FKM
Contact surface		gold plated (Au)
Flammability		V-2
Cable		
Sheathing		PUR based on polyether
Core insulation		PP
Chemical resistance		good
Microbial resistance		yes
Hydrolysis resistance		yes

Release date: 2023-06-20 Date of issue: 2023-06-20 Filename: 240819-0002_eng.pdf

Refer to "General Notes Relating to Pepperl+Fuchs Product Information".

Pepperl+Fuchs Group
www.pepperl-fuchs.com

USA: +1 330 486 0001
fa-info@us.pepperl-fuchs.com

Germany: +49 621 776 1111
fa-info@de.pepperl-fuchs.com



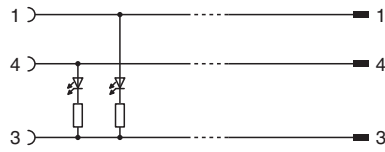
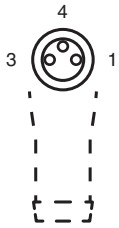

Singapore: +65 6779 9091
fa-info@sg.pepperl-fuchs.com

 PEPPERL+FUCHS

Connection



Accessories

	MH V3-SCREWDRIVER	Torque screwdriver (0.4 Nm)
	MH V3-BIT M8	plug-in cap for M8
	V1/V3-LABELHOLDER	Label holder
	V1/V3-LABEL	Label plate
	MH V3-Holder	Modular universal holder for M8 connectors