



Background suppression sensor

ML4.2-8-H-21-22-RT/40b/110/115



- Precise background suppression
- Very small black-white difference
- Small, sharp light spot
- Highly visible LEDs for Power-On, switching status, short-circuit, and undervoltage
- Metal-reinforced fastening holes
- Tamper-proof version with no adjustments
- Push-pull output

Background suppression sensor



Function

The ML100 series is characterized by its miniature housing with integral, all-metal threaded bushings. All versions are equipped with a visible red transmitter LED. This greatly simplifies installation and commissioning. The switching states are easily visible from all directions thanks to the highly visible LEDs.

Dimensions

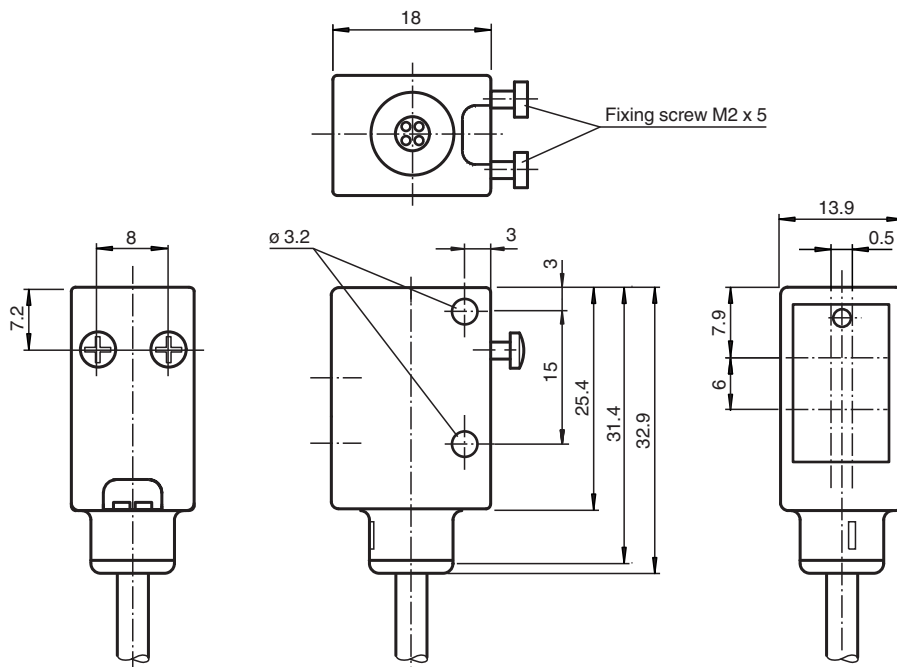

Release date: 2021-09-29 Date of issue: 2021-09-29 Filename: 240849_eng.pdf

Refer to "General Notes Relating to Pepperl+Fuchs Product Information".

Pepperl+Fuchs Group
www.pepperl-fuchs.com

USA: +1 330 486 0001
fa-info@us.pepperl-fuchs.com

Germany: +49 621 776 1111
fa-info@de.pepperl-fuchs.com

Singapore: +65 6779 9091
fa-info@sg.pepperl-fuchs.com

PF PEPPERL+FUCHS

Technical Data

General specifications		
Detection range		on white (90 %): : 10 ... 21 mm , on black (6 %): 10 ... 20 mm
Detection range max.		5 ... 22 mm
Background suppression		starts from 22 mm
Light source		LED
Light type		modulated visible red light , 660 nm
Black-white difference (6 %/90 %)		approx. 1 mm
Diameter of the light spot		approx. 1.5 mm at 21 mm
Angle of divergence		approx. 5 °
Ambient light limit		
Continuous light		40000 Lux
Modulated light		5000 Lux
Functional safety related parameters		
MTTF _d		1940 a
Mission Time (T _M)		20 a
Diagnostic Coverage (DC)		0 %
Indicators/operating means		
Operation indicator		LED green, statically lit Power on , Undervoltage indicator: Green LED, pulsing (approx. 0.8 Hz) , short-circuit : LED green flashing (approx. 4 Hz)
Function indicator		LED yellow: lights when object is detected
Electrical specifications		
Operating voltage	U _B	10 ... 30 V DC
Ripple		10 %
No-load supply current	I ₀	< 25 mA
Output		
Switching type		light/dark on electrically switchable
Signal output		Push-pull output, short-circuit protected, reverse polarity protected
Switching voltage		max. 30 V DC
Switching current		max. 100 mA
Voltage drop	U _d	≤ 2.5 V DC
Switching frequency	f	1000 Hz
Response time		0.5 ms
Conformity		
Product standard		EN 60947-5-2
Compliance with standards and directives		
Standard conformity		
Shock and impact resistance		IEC / EN 60068. half-sine, 40 g in each X, Y and Z directions
Vibration resistance		IEC / EN 60068-2-6. Sinus. 10 -150 Hz, 5 g in each X, Y and Z directions
Approvals and certificates		
CE conformity		yes
UL approval		cULus Listed
CCC approval		CCC approval / marking not required for products rated ≤36 V
Ambient conditions		
Ambient temperature		-20 ... 60 °C (-4 ... 140 °F)
Storage temperature		-20 ... 75 °C (-4 ... 167 °F)
Mechanical specifications		
Housing width		13.9 mm
Housing height		31.4 mm
Housing depth		18 mm
Degree of protection		IP67 / IP69K
Connection		2 m fixed cable
Material		
Housing		ABS

Release date: 2021-09-29 Date of issue: 2021-09-29 Filename: 240949_eng.pdf

Technical Data

Optical face	glass pane
Cable	PUR
Mass	approx. 15 g

Connection Assignment

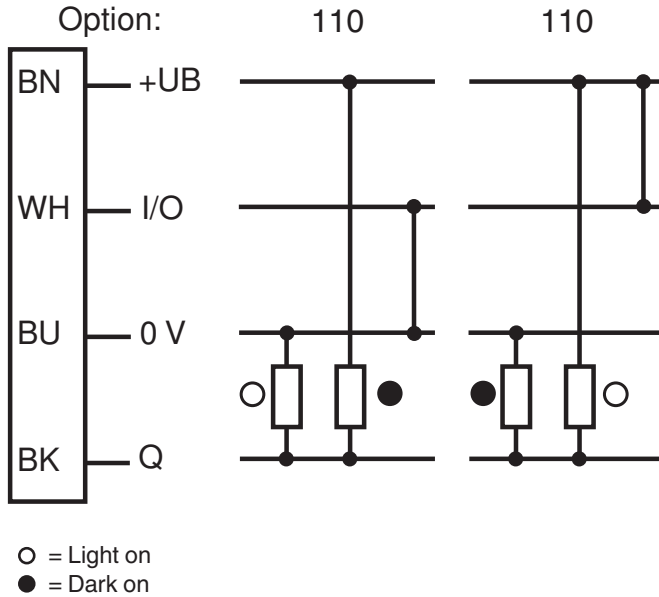

Assembly

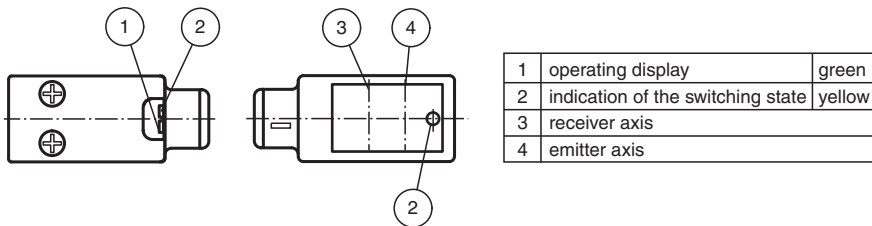



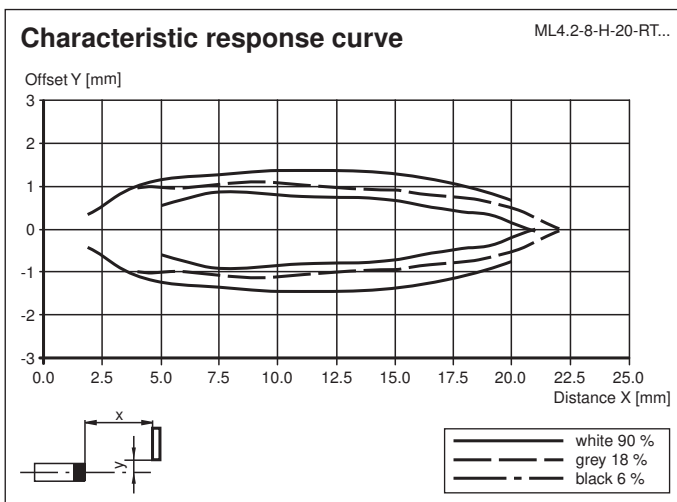

Characteristic Curve

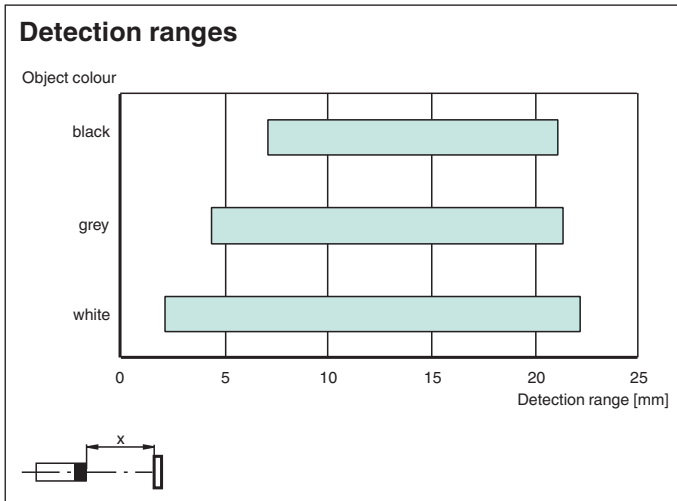

Release date: 2021-09-29 Date of issue: 2021-09-29 Filename: 240849_eng.pdf



Accessories

	OMH-4.1	Mounting Clamp
	OMH-ML6	Mounting bracket
	OMH-ML6-U	Mounting bracket
	OMH-ML6-Z	Mounting bracket

Release date: 2021-09-29 Date of issue: 2021-09-29 Filename: 240849_eng.pdf