

Distance sensor

VDM100-50-P/G2/146



- Measuring method PRT (Pulse Ranging Technology)
- Version for low temperature applications
- Non-contact precision measurement
- Ultra-fast data acquisition
- Active dynamic control
- Modern lightweight design, extremely robust
- Simple programming with 4 keys and luminous display

Distance sensor for positioning tasks accurate to the millimeter, PRT, measuring range up to 50 m, PROFIBUS, M12 plug, low temperature version



Function

Series VDM 100 laser distance measurement devices are designed for high distances. They have a repeat accuracy of 0.5 mm. SSI and fieldbusses are used as value interfaces. These devices are used for precise positioning of rack operating units, gantry cranes, railbound vehicles, elevators and other linear movable units.

Application

- Precise positioning of stock feeders
- Precise and rapid positioning of moving carriages
- For use on gantry cranes and lifting equipment

Safety Information

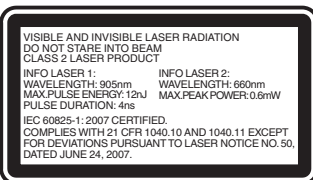

Safety Information

Laser Class 2 Information

- Caution: visible and invisible laser radiation, do not look into the beam!
- The irradiation can lead to irritation especially in a dark environment. Do not point at people!
- Maintenance and repairs should only be carried out by authorized service personnel!
- Attach the device so that the warning is clearly visible and readable.
- Caution – Use of controls or adjustments or performance of procedures other than those specified herein may result in hazardous radiation exposure.

Release date: 2021-11-11 Date of issue: 2021-11-11 Filename: 241262_eng.pdf

Refer to "General Notes Relating to Pepperl+Fuchs Product Information".

Pepperl+Fuchs Group
www.pepperl-fuchs.com

USA: +1 330 486 0001
fa-info@us.pepperl-fuchs.com

Germany: +49 621 776 1111
fa-info@de.pepperl-fuchs.com

Singapore: +65 6779 9091
fa-info@sg.pepperl-fuchs.com

PF PEPPERL+FUCHS

Dimensions

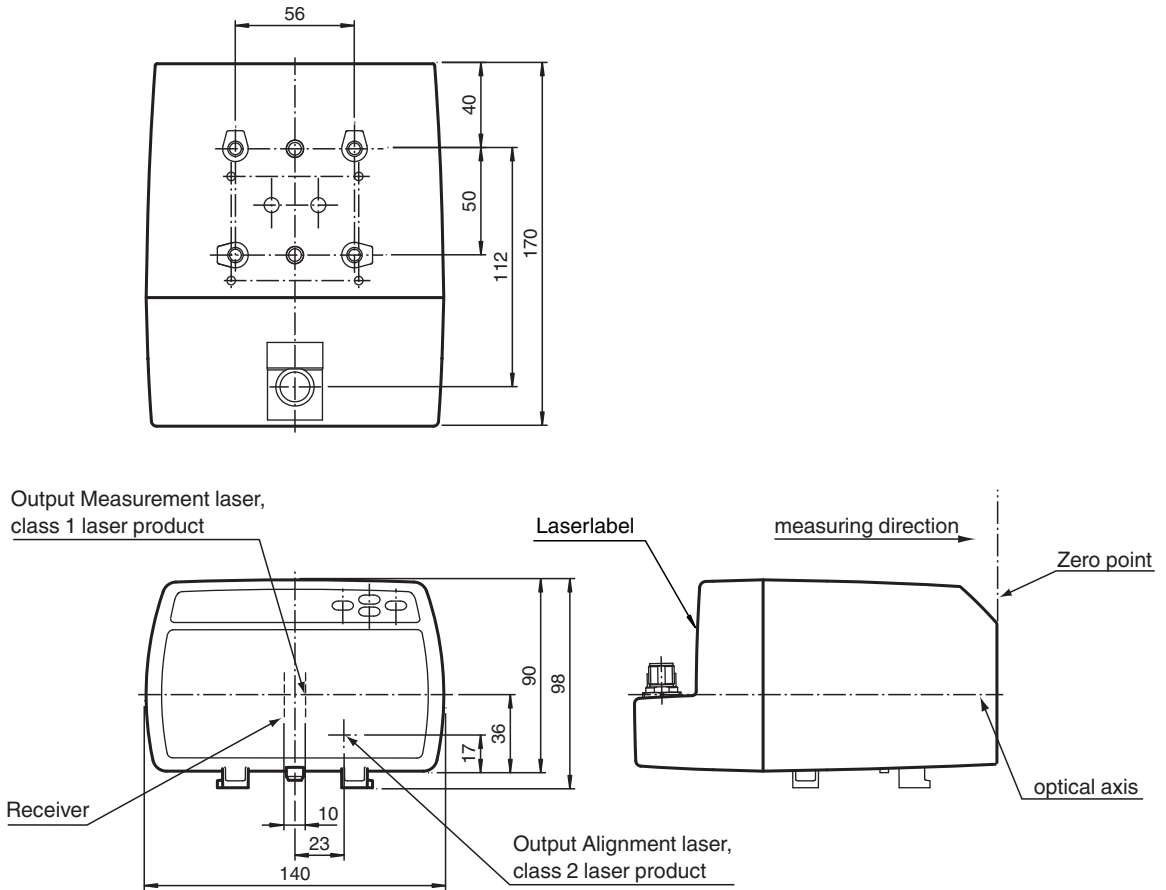

Technical Data

General specifications	
Measurement range	0.3 ... 50 m
Reference target	Foil reflector 500 mm x 500 mm
Light source	laser diode
Laser nominal ratings	
Note	VISIBLE AND INVISIBLE LASER RADIATION , DO NOT STARE INTO BEAM
Laser class	Measuring laser: 1 Alignment laser: 2
Wave length	Measuring laser: 905 nm Alignment laser: 660 nm
Beam divergence	Measuring laser: 2 mrad Alignment laser: 1 mrad
Pulse length	Measuring laser: 4 ns
Repetition rate	Measuring laser: 20 kHz
Maximum optical power output	Alignment laser: 0.6 mW
max. pulse energy	Measuring laser: 12 nJ
Measuring method	Pulse Ranging Technology (PRT)
Max. Motion velocity	15 m/s
Alignment aid	Laser pointer Laser class 2
Life span	> 100000 h
Diameter of the light spot	< 15 cm at 50 m
Ambient light limit	> 100000 Lux
Resolution	0.1 mm , adjustable
Temperature influence	0.03 mm/K
Functional safety related parameters	

Release date: 2021-11-11 Date of issue: 2021-11-11 Filename: 241262_eng.pdf

Refer to "General Notes Relating to Pepperl+Fuchs Product Information".

Technical Data

MTTF _d		89 a
Mission Time (T _M)		20 a
Diagnostic Coverage (DC)		0 %
Indicators/operating means		
Function indicator		4 LEDs
Control elements		Control panel (4 membrane keys) for setting parameters
Parameterization indicator		Illuminated display for displaying measured values and parameterization
Electrical specifications		
Operating voltage	U _B	18 ... 30 V DC
No-load supply current	I ₀	250 mA (18 V) ... 150 mA (30 V)
Protection class		III (operating voltage 50 V)
Time delay before availability	t _v	< 10 s (-30 °C after 5 min.)
Interface		
Interface type		PROFIBUS DP acc. to EN 50170
Transfer rate		9.6 kbit/s ... 12 Mbit/s , adjustable
Input/Output		
Input/output type		2 PNP inputs/outputs, independent configuration, short-circuit protected, reverse polarity protected
Input		
Switching threshold		low: U _e < 6 V, high: U _e > 16 V
Output		
Switching threshold		low: U _a < 1 V, high: U _a > U _b - 1 V
Switching current		200 mA per output
Conformity		
Product standard		EN 60947-5-2
Laser safety		IEC 60825-1:2007
Measurement accuracy		
Measured value output		1 ms
Average data age		3 ms , 6 ms , 12 ms , 25 ms , 50 ms , adjustable
Offset		max. 2 mm (between two devices)
Absolute accuracy		± 2.5 mm (> 3 m); ± 3.5 mm (0.3 m to 3 m)
Repeat accuracy		< 0.5 mm
Approvals and certificates		
EAC conformity		TR CU 020/2011
UL approval		cULus Listed, Class 2 Power Source, Type 1 enclosure
FDA approval		IEC 60825-1:2007 Complies with 21 CFR 1040.10 and 1040.11 except for deviations pursuant to Laser Notice No. 50, dated June 24, 2007
Ambient conditions		
Ambient temperature		-30 ... 50 °C (-22 ... 122 °F) , For use in dry cold
Storage temperature		-30 ... 70 °C (-22 ... 158 °F)
Relative humidity		95 % , no moisture condensation
Mechanical specifications		
Housing width		140 mm
Housing height		100 mm
Degree of protection		IP65
Connection		4-pin, M12x1 connector, standard (supply) , 5-pin, M12x1 connector, B-coded (Bus In) , 5-pin, M12x1 socket, B-coded (Bus Out) , 8-pin, M12x1 connector, service
Material		
Housing		ABS / PC
Optical face		PMMA , hard coated
Mass		approx. 700 g

Release date: 2021-11-11 Date of issue: 2021-11-11 Filename: 241262_eng.pdf

Refer to "General Notes Relating to Pepperl+Fuchs Product Information".

Pepperl+Fuchs Group
www.pepperl-fuchs.comUSA: +1 330 486 0001
fa-info@us.pepperl-fuchs.comGermany: +49 621 776 1111
fa-info@de.pepperl-fuchs.comSingapore: +65 6779 9091
fa-info@sg.pepperl-fuchs.com

PEPPERL+FUCHS

Connection Assignment

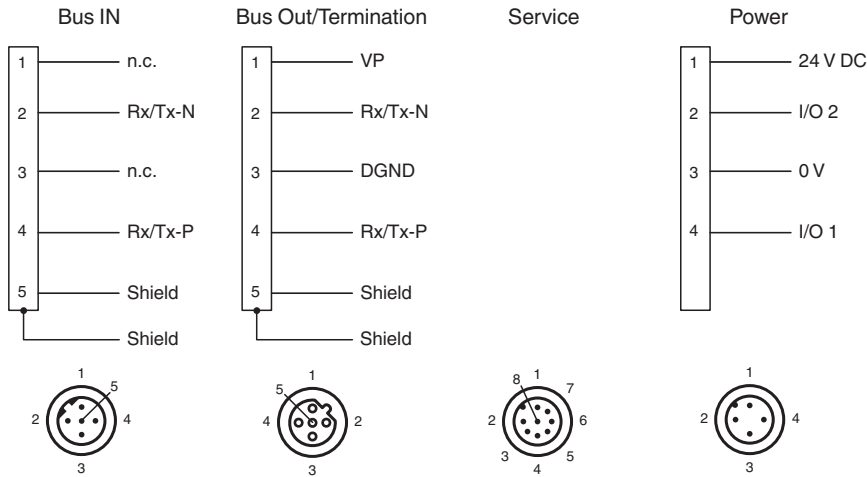

Assembly

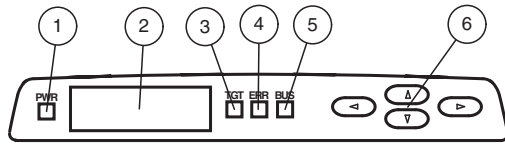

1	Power-LED	green
2	Display	
3	TARGET-LED	green
4	ERROR-LED	red
5	BUS-LED	green
6	Control keys	

Installation

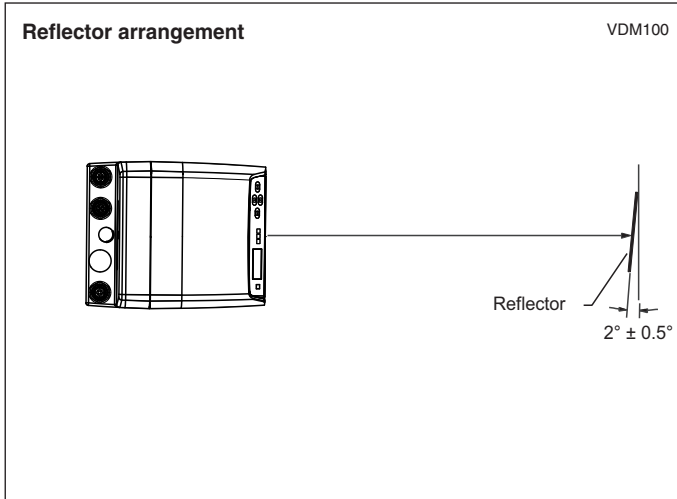





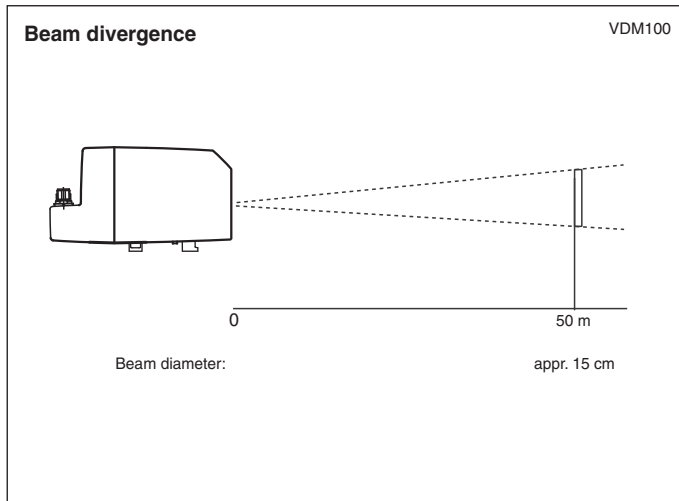







Release date: 2021-11-11 Date of issue: 2021-11-11 Filename: 241262_eng.pdf

Characteristic Curve



Accessories

	V15-G-PG9	Female connector, M12, 5-pin, field attachable
	V15SB-G-ABG-PG9	Cable connector, M12, for PROFIBUS, adjustable
	V15B-G-ABG-PG9	Cable socket, M12, for PROFIBUS, adjustable
	ICZ-TR-V15B	Terminal resistor for PROFIBUS
	Funktionserdung LS610/VDM100 Zubehoer	Function grounding for LS610 / LS611 / VDM100 series
	Schutzkappe LS610 Zubehoer	M12 protective cap set (connector + socket) for series LS610 / LS611
	OMH-VDM100-01	Mounting bracket with deviation mirror for distance measurement devices
	OMH-LS610-01	Mounting bracket for optical data coupler
	OMH-LS610-01	Mounting bracket for optical data coupler
	OMH-LS610-02	Direct mounting set consisting of 4 x M4 threaded inserts
	OMH-LS610-32	Mounting bracket for optical data coupler and distance measurement devices
	OFR-500/500	Reflective tape
	OFR-1000/1000	Reflective tape 1000 mm x 1000 mm

Release date: 2021-11-11 Date of issue: 2021-11-11 Filename: 241262_eng.pdf