

# Distance sensor

## VDM100-300-P/G2



- Measuring method PRT (Pulse Ranging Technology)
- Non-contact precision measurement
- Ultra-fast data acquisition
- Active dynamic control
- Modern lightweight design, extremely robust
- Simple programming with 4 keys and luminous display

Distance sensor for positioning tasks accurate to the millimeter, PRT, measuring range up to 300 m, PROFIBUS, M12 plug



### Function

Series VDM 100 laser distance measurement devices are designed for high distances. They have a repeat accuracy of 0.5 mm. SSI and fieldbusses are used as value interfaces. These devices are used for precise positioning of rack operating units, gantry cranes, railbound vehicles, elevators and other linear movable units.

### Application

- Precise positioning of stock feeders
- Precise and rapid positioning of moving carriages
- For use on gantry cranes and lifting equipment

### Safety Information

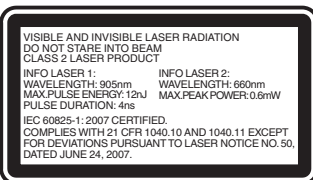

### Safety Information

#### Laser Class 2 Information

- Caution: visible and invisible laser radiation, do not look into the beam!
- The irradiation can lead to irritation especially in a dark environment. Do not point at people!
- Maintenance and repairs should only be carried out by authorized service personnel!
- Attach the device so that the warning is clearly visible and readable.
- Caution – Use of controls or adjustments or performance of procedures other than those specified herein may result in hazardous radiation exposure.

Release date: 2021-11-11 Date of issue: 2021-11-11 Filename: 241271\_eng.pdf

Refer to "General Notes Relating to Pepperl+Fuchs Product Information".

Pepperl+Fuchs Group  
www.pepperl-fuchs.com

USA: +1 330 486 0001  
fa-info@us.pepperl-fuchs.com

Germany: +49 621 776 1111  
fa-info@de.pepperl-fuchs.com

Singapore: +65 6779 9091  
fa-info@sg.pepperl-fuchs.com

**PEPPERL+FUCHS**

**Dimensions**

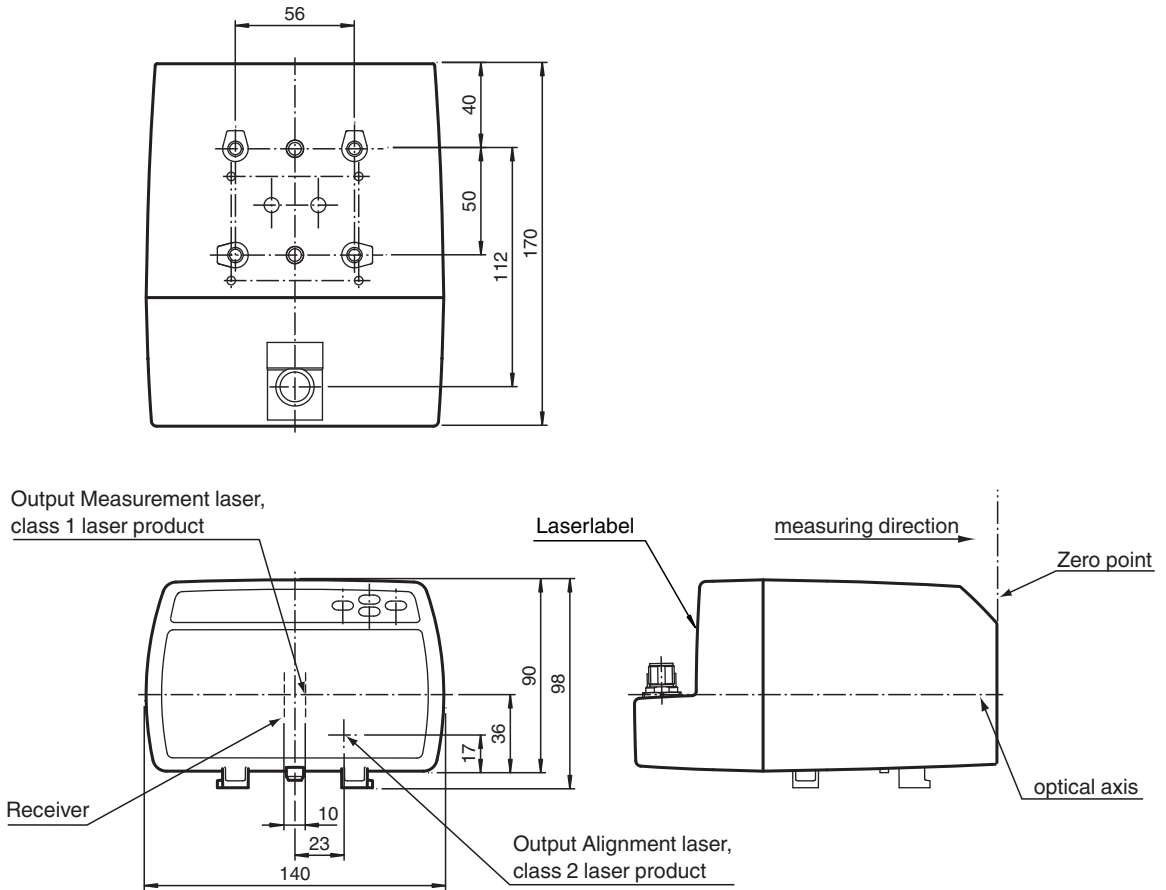

**Technical Data**

General specifications	
Measurement range	0.3 ... 300 m
Reference target	Reflector VDM01
Light source	laser diode
Laser nominal ratings	
Note	VISIBLE AND INVISIBLE LASER RADIATION , DO NOT STARE INTO BEAM
Laser class	Measuring laser: 1 Alignment laser: 2
Wave length	Measuring laser: 905 nm Alignment laser: 660 nm
Beam divergence	Measuring laser: 2 mrad Alignment laser: 1 mrad
Pulse length	Measuring laser: 4 ns
Repetition rate	Measuring laser: 20 kHz
Maximum optical power output	Alignment laser: 0.6 mW
max. pulse energy	Measuring laser: 12 nJ
Measuring method	Pulse Ranging Technology (PRT)
Max. Motion velocity	15 m/s
Alignment aid	Laser pointer Laser class 2
Life span	> 100000 h
Diameter of the light spot	< 70 cm at 300 m
Ambient light limit	> 100000 Lux
Resolution	0.1 mm , adjustable
Temperature influence	0.03 mm/K
Functional safety related parameters	

Release date: 2021-11-11 Date of issue: 2021-11-11 Filename: 241271\_eng.pdf

Refer to "General Notes Relating to Pepperl+Fuchs Product Information".

## Technical Data

MTTF <sub>d</sub>		89 a
Mission Time (T <sub>M</sub> )		20 a
Diagnostic Coverage (DC)		0 %
<b>Indicators/operating means</b>		
Function indicator		4 LEDs
Control elements		Control panel (4 membrane keys) for setting parameters
Parameterization indicator		Illuminated display for displaying measured values and parameterization
<b>Electrical specifications</b>		
Operating voltage	U <sub>B</sub>	18 ... 30 V DC
No-load supply current	I <sub>0</sub>	250 mA (18 V) ... 150 mA (30 V)
Protection class		III (operating voltage 50 V)
Time delay before availability	t <sub>v</sub>	< 10 s
<b>Interface</b>		
Interface type		PROFIBUS DP acc. to EN 50170
Transfer rate		9.6 kbit/s ... 12 Mbit/s , adjustable
<b>Input/Output</b>		
Input/output type		2 PNP inputs/outputs, independent configuration, short-circuit protected, reverse polarity protected
<b>Input</b>		
Switching threshold		low: U <sub>e</sub> < 6 V, high: U <sub>e</sub> > 16 V
<b>Output</b>		
Switching threshold		low: U <sub>a</sub> < 1 V, high: U <sub>a</sub> > U <sub>b</sub> - 1 V
Switching current		200 mA per output
<b>Conformity</b>		
Product standard		EN 60947-5-2
Laser safety		IEC 60825-1:2007
<b>Measurement accuracy</b>		
Measured value output		1 ms
Average data age		3 ms , 6 ms , 12 ms , 25 ms , 50 ms , adjustable
Offset		max. 2 mm (between two devices)
Absolute accuracy		± 2.5 mm (> 3 m); ± 3.5 mm (0.3 m to 3 m)
Repeat accuracy		< 0.5 mm
<b>Approvals and certificates</b>		
EAC conformity		TR CU 020/2011
UL approval		cULus Listed, Class 2 Power Source, Type 1 enclosure
FDA approval		IEC 60825-1:2007 Complies with 21 CFR 1040.10 and 1040.11 except for deviations pursuant to Laser Notice No. 50, dated June 24, 2007
<b>Ambient conditions</b>		
Ambient temperature		-10 ... 50 °C (14 ... 122 °F)
Storage temperature		-20 ... 70 °C (-4 ... 158 °F)
Relative humidity		95 % , no moisture condensation
<b>Mechanical specifications</b>		
Housing width		140 mm
Housing height		100 mm
Degree of protection		IP65
Connection		4-pin, M12x1 connector, standard (supply) , 5-pin, M12x1 connector, B-coded (Bus In) , 5-pin, M12x1 socket, B-coded (Bus Out) , 8-pin, M12x1 connector, service
Material		
Housing		ABS / PC
Optical face		PMMA , hard coated
Mass		approx. 700 g

Release date: 2021-11-11 Date of issue: 2021-11-11 Filename: 2411271\_eng.pdf

Refer to "General Notes Relating to Pepperl+Fuchs Product Information".

Pepperl+Fuchs Group  
www.pepperl-fuchs.comUSA: +1 330 486 0001  
fa-info@us.pepperl-fuchs.comGermany: +49 621 776 1111  
fa-info@de.pepperl-fuchs.comSingapore: +65 6779 9091  
fa-info@sg.pepperl-fuchs.com

**PEPPERL+FUCHS**

## Connection Assignment

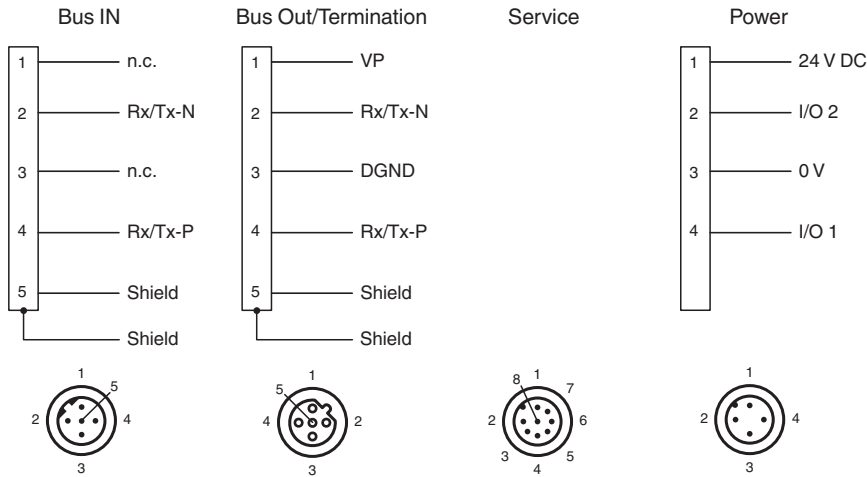

## Assembly

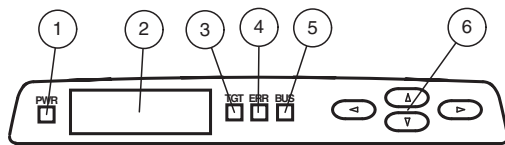

1	Power-LED	green
2	Display	
3	TARGET-LED	green
4	ERROR-LED	red
5	BUS-LED	green
6	Control keys	

## Installation

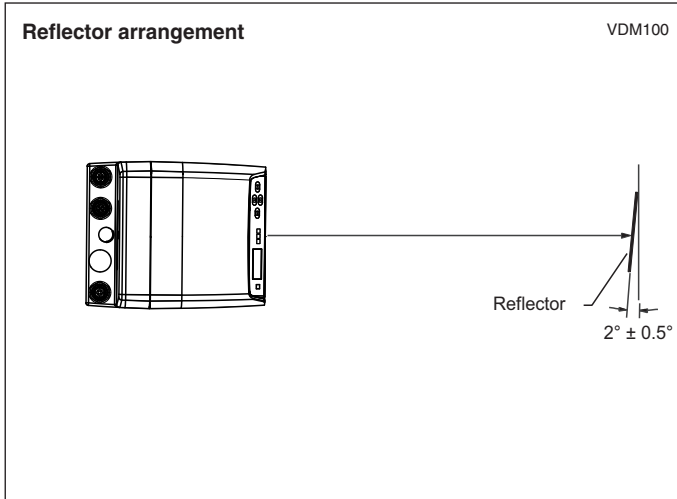





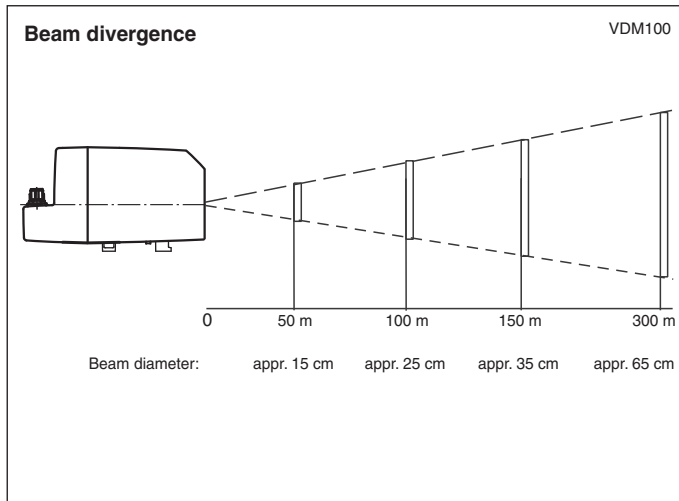









Release date: 2021-11-11 Date of issue: 2021-11-11 Filename: 241271\_eng.pdf

## Technical Features



## Accessories

	<b>V15-G-PG9</b>	Female connector, M12, 5-pin, field attachable
	<b>V15SB-G-ABG-PG9</b>	Cable connector, M12, for PROFIBUS, adjustable
	<b>V15B-G-ABG-PG9</b>	Cable socket, M12, for PROFIBUS, adjustable
	<b>ICZ-TR-V15B</b>	Terminal resistor for PROFIBUS
	<b>Funktionserdung LS610/VDM100 Zubehoer</b>	Function grounding for LS610 / LS611 / VDM100 series
	<b>Schutzkappe LS610 Zubehoer</b>	M12 protective cap set (connector + socket) for series LS610 / LS611
	<b>OMH-VDM100-01</b>	Mounting bracket with deviation mirror for distance measurement devices
	<b>OMH-LS610-01</b>	Mounting bracket for optical data coupler
	<b>OMH-LS610-01</b>	Mounting bracket for optical data coupler
	<b>OMH-LS610-02</b>	Direct mounting set consisting of 4 x M4 threaded inserts
	<b>OMH-LS610-32</b>	Mounting bracket for optical data coupler and distance measurement devices
	<b>REF-VDM01</b>	Reflector for distance measurement devices
	<b>REF-VDM02</b>	Reflector for distance measurement devices
	<b>OFR-500/500</b>	Reflective tape

Release date: 2021-11-11 Date of issue: 2021-11-11 Filename: 241271\_eng.pdf

Refer to "General Notes Relating to Pepperl+Fuchs Product Information".

 Pepperl+Fuchs Group  
www.pepperl-fuchs.com

 USA: +1 330 486 0001  
fa-info@us.pepperl-fuchs.com

 Germany: +49 621 776 1111  
fa-info@de.pepperl-fuchs.com

 Singapore: +65 6779 9091  
fa-info@sg.pepperl-fuchs.com

 **PEPPERL+FUCHS**

## Accessories

	<b>OFR-1000/1000</b>	Reflective tape 1000 mm x 1000 mm
-----------------------------------------------------------------------------------	----------------------	-----------------------------------

Release date: 2021-11-11 Date of issue: 2021-11-11 Filename: 241271\_eng.pdf

Refer to "General Notes Relating to Pepperl+Fuchs Product Information".

Pepperl+Fuchs Group  
www.pepperl-fuchs.com

USA: +1 330 486 0001  
fa-info@us.pepperl-fuchs.com

Germany: +49 621 776 1111  
fa-info@de.pepperl-fuchs.com

Singapore: +65 6779 9091  
fa-info@sg.pepperl-fuchs.com