

# Connection cable, shielded

## V15-W-3,5M-PUR-ABG-V15-G



- Degree of protection IP68 / IP69
- Halogen-free
- Shield connected to screw connection
- Specific design protects against loosening and inaccurate installation

Cordset M12 socket angled to M12 plug straight A-coded, 5-pin, PUR cable grey, shielded



### Dimensions

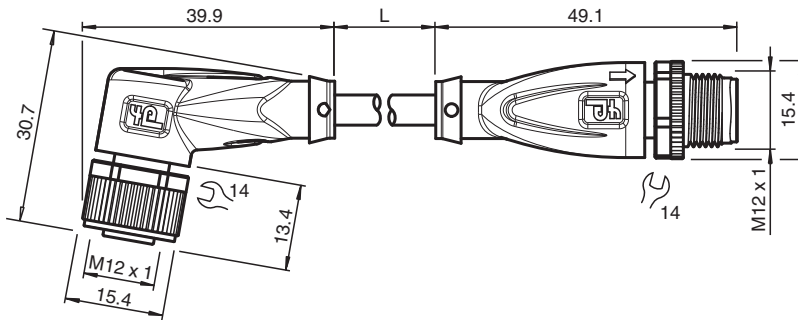

### Technical Data

#### General specifications

Connector 1	
Connection	socket
Construction type	M12
Style	angled
Locking	screw connection
Number of pins	5
Coding	A-coded
Connector 2	
Connection	plug
Construction type	M12
Style	straight
Locking	screw connection
Number of pins	5
Coding	A-coded

#### Electrical specifications

Operating voltage	$U_B$	max. 48 V AC / 60 V DC
Operating current	$I_B$	max. 4 A

#### Conformity

Degree of protection	EN 60529
Plug connection	connector M12 x 1 : IEC 61076-2-101

Release date: 2023-07-05 Date of issue: 2023-07-05 Filename: 241466\_eng.pdf

Refer to "General Notes Relating to Pepperl+Fuchs Product Information".

Pepperl+Fuchs Group  
www.pepperl-fuchs.com

USA: +1 330 486 0001  
fa-info@us.pepperl-fuchs.com

Germany: +49 621 776 1111  
fa-info@de.pepperl-fuchs.com

Singapore: +65 6779 9091  
fa-info@sg.pepperl-fuchs.com

PEPPERL+FUCHS

## Technical Data

Halogen-free	DIN VDE 0472-815 DIN EN 50267-2-1	
<b>Ambient conditions</b>		
Ambient temperature		
Plug connector		-40 ... 90 °C (-40 ... 194 °F)
Cable, fixed		-40 ... 80 °C (-40 ... 176 °F)
Cable, flexing		-25 ... 80 °C (-13 ... 176 °F)
Pollution degree		3
<b>Mechanical specifications</b>		
Plug connector		
Tightening torque		0.6 Nm
Loosening protection		available
Tool installation		straight knurling and hexagon nut SW = 14 mm
Mating cycles		min. 100
Shielding		shield connected to screw connection
Degree of protection		IP68 / IP69
Cable		
Sheath diameter		4.8 mm
Bending radius		> 10 x cable diameter, moving > 5 x cable diameter, fixed
Sheath stripping force		max. 100 N / 300 mm
Sheath color		grey (similar to RAL 7001)
Number of cores		5
Core cross section		0.34 mm <sup>2</sup>
Cores color		Core 1: brown Core 2: white Core 3: blue Core 4: black Core 5: grey
Core construction		42 x 0.1 mm Ø
Shield		tinned copper braiding, 85 % coverage
Length	L	3.5 m
Cable code		Li 9Y 11YM 5 x 0.34
<b>Material</b>		
Halogen-free		yes
Plug connector		
Screw connection		Zinc diecast, nickel-plated
Body		TPU, black
Seal		FKM
Contact surface		gold plated (Au)
Flammability		V-2
Cable		
Sheathing		PUR based on polyether
Core insulation		PP
Chemical resistance		good

## Connection

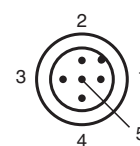
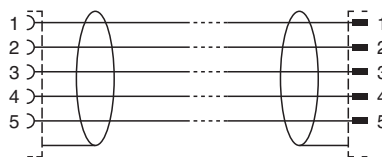
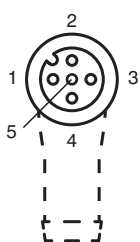

Release date: 2023-07-05 Date of issue: 2023-07-05 Filename: 241466\_eng.pdf

Refer to "General Notes Relating to Pepperl+Fuchs Product Information".

Pepperl+Fuchs Group  
www.pepperl-fuchs.com







USA: +1 330 486 0001  
fa-info@us.pepperl-fuchs.com

Germany: +49 621 776 1111  
fa-info@de.pepperl-fuchs.com

Singapore: +65 6779 9091  
fa-info@sg.pepperl-fuchs.com

**PF** PEPPERL+FUCHS

**Accessories**

	<b>MH V1-SCREWDRIVER</b>	Torque screwdriver (0.6 Nm)
	<b>MH V1-BIT M12</b>	plug-in cap M12
	<b>V1/V3-LABELHOLDER</b>	Label holder
	<b>V1/V3-LABEL</b>	Label plate
	<b>MH V1-Holder</b>	Modular universal holder for M12 connectors
	<b>V1-CLIP</b>	Unlocking protector for M12 connector
	<b>V1-MARKING-RING-COLOR</b>	Marking rings for M12 connectors, various colors

Release date: 2023-07-05 Date of issue: 2023-07-05 Filename: 241466\_eng.pdf

Refer to "General Notes Relating to Pepperl+Fuchs Product Information".

Pepperl+Fuchs Group  
www.pepperl-fuchs.com

USA: +1 330 486 0001  
fa-info@us.pepperl-fuchs.com

Germany: +49 621 776 1111  
fa-info@de.pepperl-fuchs.com

Singapore: +65 6779 9091  
fa-info@sg.pepperl-fuchs.com