

# Connection cable

## V3-WM-10M-PVC-V3-GM



- Degree of protection IP68
- Specific design protects against loosening and inaccurate installation

Cordset M8 socket angled to M8 plug straight A-coded, 3-pin, PVC cable grey



### Dimensions

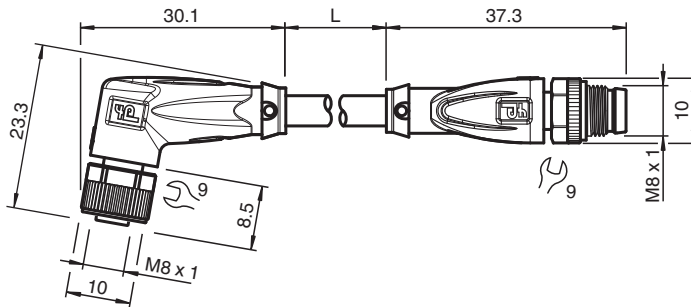

### Technical Data

#### General specifications

Connector 1		
Connection		socket
Construction type		M8
Style		angled
Locking		screw connection
Number of pins		3
Coding		A-coded
Connector 2		
Connection		plug
Construction type		M8
Style		straight
Locking		screw connection
Number of pins		3
Coding		A-coded

#### Electrical specifications

Operating voltage	$U_B$	max. 48 V AC / 60 V DC
Operating current	$I_B$	max. 3 A

#### Conformity

Degree of protection		EN 60529
Plug connection		connector M8 x 1 : IEC 61076-2-104

#### Ambient conditions

Release date: 2023-06-20 Date of issue: 2023-06-20 Filename: 2411633\_eng.pdf

Refer to "General Notes Relating to Pepperl+Fuchs Product Information".

Pepperl+Fuchs Group  
www.pepperl-fuchs.com

USA: +1 330 486 0001  
fa-info@us.pepperl-fuchs.com

Germany: +49 621 776 1111  
fa-info@de.pepperl-fuchs.com

Singapore: +65 6779 9091  
fa-info@sg.pepperl-fuchs.com

**PF** PEPPERL+FUCHS

### Technical Data

<b>Ambient temperature</b>		
Plug connector		-40 ... 90 °C (-40 ... 194 °F)
Cable, fixed		-40 ... 70 °C (-40 ... 158 °F)
Cable, flexing		-5 ... 70 °C (23 ... 158 °F)
Pollution degree		3
<b>Mechanical specifications</b>		
Plug connector		
Tightening torque		0.4 Nm
Loosening protection		available
Tool installation		straight knurling and hexagon nut SW = 9 mm
Mating cycles		min. 100
Degree of protection		IP68
Cable		
Sheath diameter		4.3 mm
Bending radius		> 15 x cable diameter, moving > 10 x cable diameter, fixed
Sheath stripping force		max. 80 N / 300 mm
Sheath color		grey (similar to RAL 7001)
Number of cores		3
Core cross section		0.25 mm <sup>2</sup>
Cores color		Core 1: brown Core 3: blue Core 4: black
Core construction		14 x 0.15 mm Ø
Length	L	10 m
Cable code		Li YY 3 x 0,25
<b>Material</b>		
Plug connector		
Screw connection		Zinc diecast, nickel-plated
Body		TPU, black
Seal		FKM
Contact surface		gold plated (Au)
Flammability		V-2
Cable		
Sheathing		PVC
Core insulation		PVC
Flammability		flame-resistant

### Connection

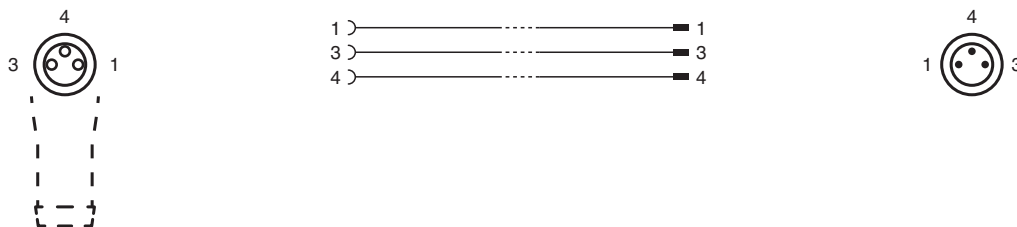





### Accessories

	<b>MH V3-SCREWDRIVER</b>	Torque screwdriver (0.4 Nm)
---	--------------------------	-----------------------------

Release date: 2023-06-20 Date of issue: 2023-06-20 Filename: 2411633\_eng.pdf

**Accessories**

	<b>MH V3-BIT M8</b>	plug-in cap for M8
	<b>V1/V3-LABELHOLDER</b>	Label holder
	<b>V1/V3-LABEL</b>	Label plate
	<b>MH V3-Holder</b>	Modular universal holder for M8 connectors

Release date: 2023-06-20 Date of issue: 2023-06-20 Filename: 241633\_eng.pdf

Refer to "General Notes Relating to Pepperl+Fuchs Product Information".

Pepperl+Fuchs Group  
www.pepperl-fuchs.com

USA: +1 330 486 0001  
fa-info@us.pepperl-fuchs.com

Germany: +49 621 776 1111  
fa-info@de.pepperl-fuchs.com

Singapore: +65 6779 9091  
fa-info@sg.pepperl-fuchs.com