



## Fiber optic sensor MLV41-LL-IR-IO/95/136



- Robust fiber optic sensor for reliable operation under all conditions
- Adjustable continuous sensitivity
- Easy fiber optic installation with quick-action clamping lock
- Aluminum housing with high-quality Delta Seal coating
- IO-Link interface for service and process data

Robust fiber optic sensor for glass fiber optics, IO-Link interface, infrared light, push-pull output, M8 plug



### Function

The unique and extremely popular design of the MLV41 series enables it be mounted correctly in confined areas and offers all the functions that are normally only found on larger phototelectric sensors. The MLV41 series comes with a range of functions. For example, highly visible status LEDs on the front and back, resistance to ambient light, crosstalk protection and universally applicable output stages that permit every possible switching logic and polarity to be realized. The enhanced resistance to ambient light ensures reliable operation even where modern energy-saving lamps with electronic ballasts are in use. The same applies where multiple devices are present, i.e. the use of a number of sensors in the same vicinity causes no problems.

### Dimensions

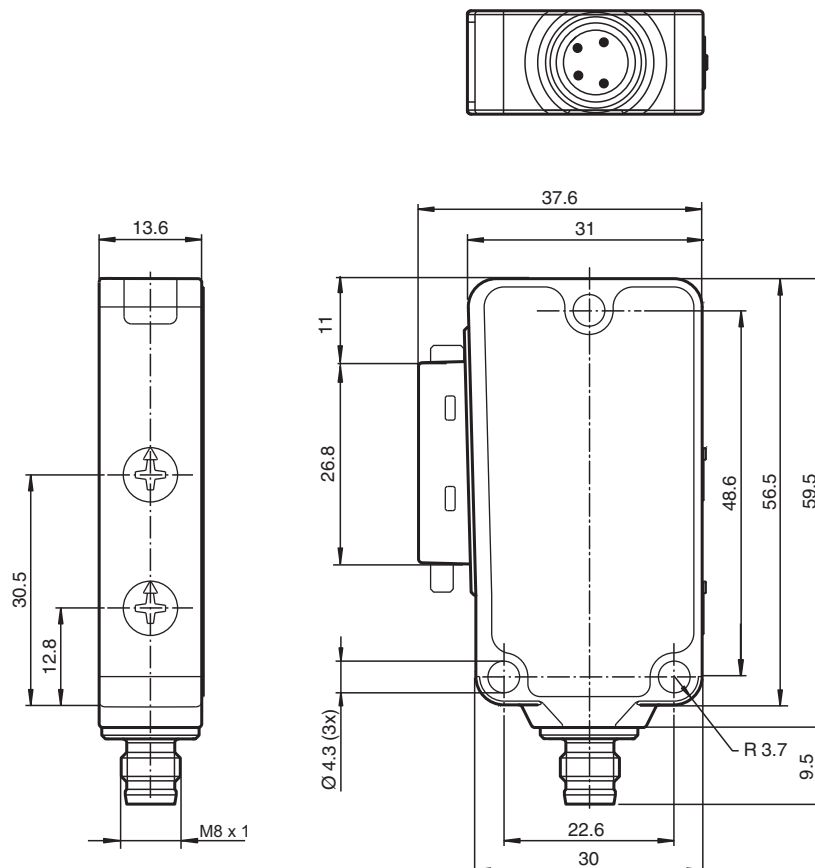

Release date: 2023-03-28 Date of issue: 2023-03-28 Filename: 249786\_eng.pdf

Refer to "General Notes Relating to Pepperl+Fuchs Product Information".

Pepperl+Fuchs Group  
www.pepperl-fuchs.com

USA: +1 330 486 0001  
fa-info@us.pepperl-fuchs.com

Germany: +49 621 776 1111  
fa-info@de.pepperl-fuchs.com

Singapore: +65 6779 9091  
fa-info@sg.pepperl-fuchs.com

**PF** PEPPERL+FUCHS

## Technical Data

General specifications		
Sensor range		on black (6 %): up to 55 mm on Kodak white, reflection factor 90% up to 160 mm with LLR 04-1.6-0.5-WC3 fiberoptic cable
Adjustment range		0 ... 160 mm on Kodak white, reflection factor 90%
Reference target		100 mm x 100 mm on Kodak white, reflection factor 90%
Light source		IREDD
Light type		modulated infrared light , 880 nm
Functional safety related parameters		
MTTF <sub>d</sub>		770 a
Mission Time (T <sub>M</sub> )		20 a
Diagnostic Coverage (DC)		0 %
Indicators/operating means		
Operation indicator		LED green, statically lit Power on , Undervoltage indicator: Green LED, pulsing (approx. 0.8 Hz) , short-circuit : LED green flashing (approx. 4 Hz) , IO link communication: green LED goes out briefly (1 Hz)
Function indicator		LED yellow, lights up with receiver lit ; flashes when falling short of the operating reserve
Control elements		sensitivity adjustment
Electrical specifications		
Operating voltage	U <sub>B</sub>	10 ... 30 V DC
Ripple		max. 10 %
No-load supply current	I <sub>0</sub>	max. 40 mA
Interface		
Interface type		IO-Link
Protocol		IO-Link V1.0
Mode		COM2 (38.4 kBit/s)
Output		
Switching type		light/dark on
Signal output		2 push-pull (4 in 1) outputs, complementary, short-circuit proof, reverse polarity protected
Switching voltage		max. 30 V DC
Switching current		max. 100 mA
Voltage drop	U <sub>d</sub>	≤ 2.5 V DC
Switching frequency	f	1000 Hz
Response time		0.5 ms
Conformity		
Product standard		EN 60947-5-2
Approvals and certificates		
UL approval		cULus Listed 57M3 (Only in association with UL Class 2 power supply; Type 1 enclosure)
CCC approval		CCC approval / marking not required for products rated ≤36 V
Ambient conditions		
Ambient temperature		-20 ... 60 °C (-4 ... 140 °F)
Storage temperature		-40 ... 75 °C (-40 ... 167 °F)
Mechanical specifications		
Housing width		31 mm
Housing height		56.5 mm
Housing depth		13.6 mm
Fiber optic adapter		04
Degree of protection		IP67
Connection		M8 x 1 connector, 4-pin
Material		
Housing		Aluminum , Delta-Seal coated
Optical face		Fiber optic connection

Release date: 2023-03-28 Date of issue: 2023-03-28 Filename: 249786\_eng.pdf

Refer to "General Notes Relating to Pepperl+Fuchs Product Information".

 Pepperl+Fuchs Group  
www.pepperl-fuchs.com

 USA: +1 330 486 0001  
fa-info@us.pepperl-fuchs.com

 Germany: +49 621 776 1111  
fa-info@de.pepperl-fuchs.com

 Singapore: +65 6779 9091  
fa-info@sg.pepperl-fuchs.com

 **PEPPERL+FUCHS**

## Technical Data

Connector	metal
Mass	50 g

## Connection Assignment

Option:

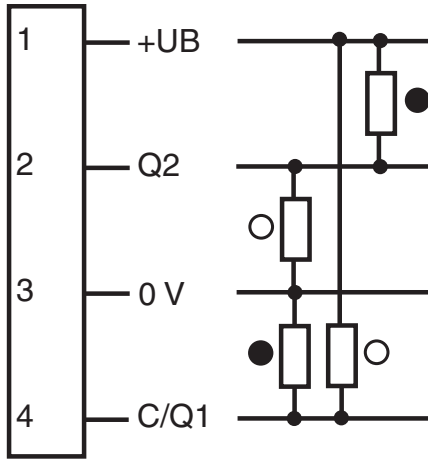

- = Light on
- = Dark on

## Connection Assignment



Wire colors in accordance with EN 60947-5-2

1	BN	(brown)
2	WH	(white)
3	BU	(blue)
4	BK	(black)



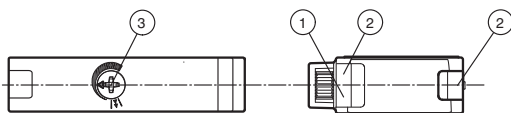

















## Assembly



1 Operating display green	3 Sensing range adjuster / adjustment mode
2 Function display yellow	

Release date: 2023-03-28 Date of issue: 2023-03-28 Filename: 249786\_eng.pdf

## Accessories

	<b>V31-WM-2M-PUR</b>	Female cordset single-ended M8 angled A-coded, 4-pin, PUR cable grey
	<b>V31-GM-2M-PUR</b>	Female cordset single-ended M8 straight A-coded, 4-pin, PUR cable grey
	<b>LCR 04-1,6-0,5-Z1</b>	Glass fiber optic - diffuse with PVC covering
	<b>LLR 04-1,6-0,5-G(M6x30)</b>	Glass fiber optic - diffuse with metal silicone covering
	<b>LCR 04-1,6-0,5-WC 3</b>	Glass fiber optic - diffuse with PVC covering
	<b>LLR 04-1,6-0,5-W C3</b>	Glass fiber optic - diffuse with metal silicone covering
	<b>LCE 04-1,6-1,0-Z1</b>	Glass fiber optic - thru-beam with PVC covering
	<b>LCE 04-1,6-1,0 G</b>	Glass fiber optic - thru-beam with PVC covering
	<b>LLE 04-1,6-1,0-G</b>	Glass fiber optic - thru-beam with metal silicone covering
	<b>LCE 04-1,6-1,0-W C3</b>	Glass fiber optic - thru-beam with PVC covering
	<b>LLE 04-1,6-1,0-W C3</b>	Glass fiber optic - thru-beam with metal silicone covering
	<b>ICE2-8IOL-G65L-V1D</b>	EtherNet/IP IO-Link master with 8 inputs/outputs
	<b>ICE3-8IOL-G65L-V1D</b>	PROFINET IO IO-Link master with 8 inputs/outputs
	<b>ICE1-8IOL-G30L-V1D</b>	Ethernet IO-Link module with 8 inputs/outputs
	<b>ICE1-8IOL-G60L-V1D</b>	Ethernet IO-Link module with 8 inputs/outputs
	<b>ICE2-8IOL-K45P-RJ45</b>	EtherNet/IP IO-Link master with 8 inputs/outputs, DIN rail, push-in connectors
	<b>ICE2-8IOL-K45S-RJ45</b>	EtherNet/IP IO-Link master with 8 inputs/outputs, DIN rail, screw terminal
	<b>ICE3-8IOL-K45P-RJ45</b>	PROFINET IO IO-Link master with 8 inputs/outputs, DIN rail, push-in terminals
	<b>ICE3-8IOL-K45S-RJ45</b>	PROFINET IO IO-Link master with 8 inputs/outputs, DIN rail, screw terminal
	<b>IO-Link-Master02-USB</b>	IO-Link master, supply via USB port or separate power supply, LED indicators, M12 plug for sensor connection

Release date: 2023-03-28 Date of issue: 2023-03-28 Filename: 249786\_eng.pdf

Refer to "General Notes Relating to Pepperl+Fuchs Product Information".

Pepperl+Fuchs Group  
www.pepperl-fuchs.comUSA: +1 330 486 0001  
fa-info@us.pepperl-fuchs.comGermany: +49 621 776 1111  
fa-info@de.pepperl-fuchs.comSingapore: +65 6779 9091  
fa-info@sg.pepperl-fuchs.com PEPPERL+FUCHS

## IO link function

The IO link operating mode is indicated by the green LED indicator with a short interruption ( $f = 1 \text{ Hz}$ ). IO link communication simultaneously provides process data (measurement data from the sensor) and access to requirement data.

The requirement data contains the following information:

### Identification:

- Manufacturer information
- Product ID
- User-specific ID

### Device parameters:

- Teach-in parameters
- Operating parameters
- Configuration parameters
- Device commands

### Diagnostic messages and warnings

## Setting information

### Detection range adjustment:

The detection range can be set via the rotary switch or the IO-Link.

#### Setting using the rotary switch:

If you would like to change the detection range on the sensor, turn:

- the rotary switch to the left to reduce the value.
- the rotary switch to the right to increase the value.

With the IO-Link, the set detection range the current rotary switch configuration is always assigned.

If the rotary switch is too far to the left or the right, perform the following:

Turn the potentiometer completely to the left until it stops. The LED will briefly flash green.

The assignment of the current rotary switch configuration to the detection range set via IO-Link is overridden.

Now set the desired detection range again.

#### Example application - manually reduce detection range:



The potentiometer has one position as shown here. The adjustable detection range is set via IO-Link to maximum. The rotary switch is too far to the left to set a considerably lower detection range for example.



Turn the potentiometer to the left until it stops to override the set value to this rotary switch configuration. The LED will briefly flash green.



Now set the desired detection range again.