

Cable socket, shielded V19-W-30M-PUR-ABG

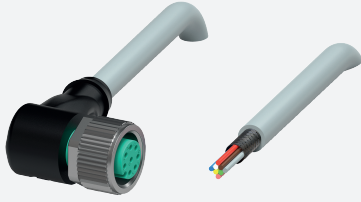

- Degree of protection IP68 / IP69
- Halogen-free
- Shield connected to screw connection
- Specific design protects against loosening and inaccurate installation

Female cordset single-ended M12 angled A-coded, 8-pin, PUR cable grey, shielded



Dimensions

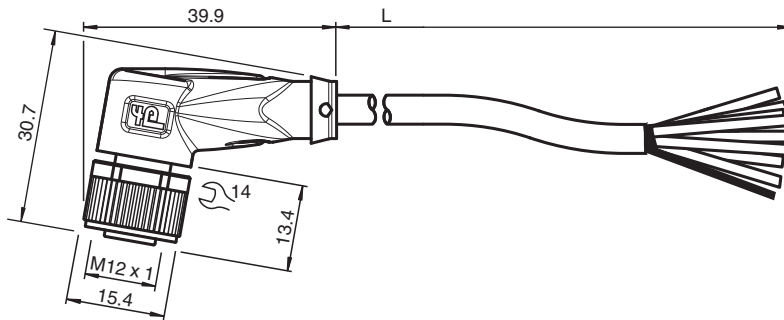

Technical Data

General specifications			
Connector 1			
Connection			socket
Construction type			M12
Style			angled
Locking			screw connection
Number of pins			8
Coding			A-coded
Connector 2			
Connection			cable end
Electrical specifications			
Operating voltage	U_B		max. 30 V AC/DC
Operating current	I_B		max. 2 A
Conformity			
Degree of protection			EN 60529
Plug connection			connector M12 x 1 : IEC 61076-2-101

Release date: 2022-11-30 Date of issue: 2022-12-01 Filename: 251797_eng.pdf

Refer to "General Notes Relating to Pepperl+Fuchs Product Information".

Pepperl+Fuchs Group
www.pepperl-fuchs.com

USA: +1 330 486 0001
fa-info@us.pepperl-fuchs.com

Germany: +49 621 776 1111
fa-info@de.pepperl-fuchs.com

Singapore: +65 6779 9091
fa-info@sg.pepperl-fuchs.com

PEPPERL+FUCHS





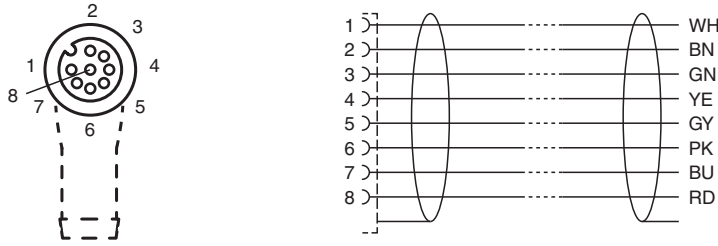

Technical Data

Halogen-free		DIN VDE 0472-815 DIN EN 50267-2-1
Ambient conditions		
Ambient temperature		
Plug connector		-40 ... 90 °C (-40 ... 194 °F)
Cable, fixed		-40 ... 80 °C (-40 ... 176 °F)
Cable, flexing		-20 ... 80 °C (-4 ... 176 °F)
Pollution degree		3
Mechanical specifications		
Plug connector		
Tightening torque		0.6 Nm
Loosening protection		available
Tool installation		straight knurling and hexagon nut SW = 14 mm
Mating cycles		min. 100
Shielding		shield connected to screw connection
Degree of protection		IP68 / IP69
Cable		according to IEC/EN 60228 (DIN VDE 0295) class 5
Sheath diameter		6 mm
Bending radius		> 10 x cable diameter, moving > 5 x cable diameter, fixed
Sheath stripping force		max. 100 N / 300 mm
Sheath color		grey (similar to RAL 7001)
Number of cores		8
Core cross section		0.25 mm ²
Cores color		Core 1: white Core 2: brown Core 3: green Core 4: yellow Core 5: grey Core 6: pink Core 7: blue Core 8: red
Core construction		14 x 0.15 mm Ø
Shield		tinned copper braiding, 85 % coverage
Length	L	30 m
Cable code		Li 9Y V1 C V1 11Y 8 x 0,25
Material		
Halogen-free		yes
Plug connector		
Screw connection		Zinc diecast, nickel-plated
Body		TPU, black
Seal		FKM
Contact surface		gold plated (Au)
Flammability		V-2
Cable		
Sheathing		PUR based on polyether
Core insulation		PP
Chemical resistance		good

Connection Assignment



Accessories

	MH V1-SCREWDRIVER	Torque screwdriver (0.6 Nm)
	MH V1-BIT M12	plug-in cap M12
	V1/V3-LABELHOLDER	Label holder
	V1/V3-LABEL	Label plate
	MH V1-Holder	Modular universal holder for M12 connectors
	V1-CLIP	Unlocking protector for M12 connector
	V1-MARKING-RING-COLOR	Marking rings for M12 connectors, various colors