

## Connection cable

### V15-W-S-YE10M-PUR-A-V15-G



- Improved resistance to weld spatter
- Suitable for drag chains and abrasion resistant
- Suitable for robotic applications / torsion resistant
- Degree of protection IP68 / IP69
- Free of paint wetting interfering substances
- Resistant to microbes and hydrolysis
- UL listed for USA and Canada
- Halogen-free
- Specific design protects against loosening and inaccurate installation

Cordset M12 socket yellow angled to M12 plug yellow straight A-coded, 5-pin, PUR cable weld spatter resistant yellow, UL approved, drag chain suitable, torsion resistant



## Dimensions

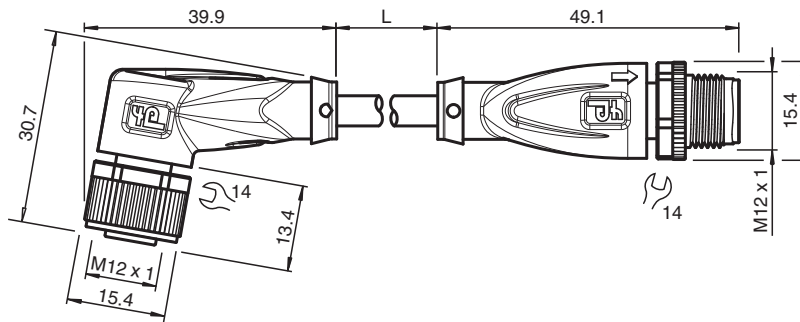

## Technical Data

General specifications			
Connector 1			
Connection		socket	
Construction type		M12	
Style		angled	
Locking		screw connection	
Number of pins		5	
Coding		A-coded	
Connector 2			
Connection		plug	
Construction type		M12	
Style		straight	
Locking		screw connection	
Number of pins		5	
Coding		A-coded	
Electrical specifications			
Operating voltage	U <sub>B</sub>	max. 48 V AC / 60 V DC	
Operating current	I <sub>B</sub>	max. 4 A	
Conformity			
Degree of protection		EN 60529	

Release date: 2023-07-05 Date of issue: 2023-07-05 Filename: 253000\_eng.pdf

Refer to "General Notes Relating to Pepperl+Fuchs Product Information".

Pepperl+Fuchs Group  
www.pepperl-fuchs.com

USA: +1 330 486 0001  
fa-info@us.pepperl-fuchs.com

Germany: +49 621 776 1111  
fa-info@de.pepperl-fuchs.com

Singapore: +65 6779 9091  
fa-info@sg.pepperl-fuchs.com

PEPPERL+FUCHS

## Technical Data

Plug connection		connector M12 x 1 : IEC 61076-2-101
Flammability		UL 1581; DIN EN 60332-2-2
Halogen-free		DIN VDE 0472-815 IEC 60754-1
Microbial resistance		DIN EN 50525-2-21 / DIN VDE 0282-10
Hydrolysis resistance		DIN EN 50525-2-21
<b>Approvals and certificates</b>		
UL approval		AWM STYLE 20549 AWM I/II A/B 80°C 300V FT2 (cable)
UL File Number		E231213
<b>Ambient conditions</b>		
Ambient temperature		
Plug connector		-40 ... 90 °C (-40 ... 194 °F)
Cable, fixed		-40 ... 80 °C (-40 ... 176 °F)
Cable, flexing		-25 ... 80 °C (-13 ... 176 °F)
Pollution degree		3
<b>Mechanical specifications</b>		
Plug connector		
Tightening torque		0.6 Nm
Loosening protection		available
Tool installation		straight knurling and hexagon nut SW = 14 mm
Mating cycles		min. 100
Degree of protection		IP68 / IP69
Cable		
Sheath diameter		4.7 mm
Bending radius		> 10 x cable diameter, moving > 5 x cable diameter, fixed
Sheath stripping force		max. 50 N / 300 mm
Sheath color		yellow (similar to RAL 1021)
Number of cores		5
Core cross section		0.34 mm <sup>2</sup>
Cores color		Core 1: brown Core 2: white Core 3: blue Core 4: black Core 5: grey
Core construction		42 x 0.1 mm Ø
Length	L	10 m
Cable code		Li F 9Y 11Y 5 x 0,34
Drag chain suitability		
Drag chain cycles		min. 5000000
Motion velocity		max. 3.3 m/s
Traverse distance		max. 5 m
Acceleration		max. 5 m/s <sup>2</sup>
Torsion cycles		min. 1000000
Torsional stress		± 180 °/m
<b>Material</b>		
PWIS free		yes
Halogen-free		yes
Plug connector		
Screw connection		Zinc diecast, nickel-plated
Body		TPU, yellow
Seal		FKM
Contact surface		gold plated (Au)
Flammability		V-2
Cable		

Release date: 2023-07-05 Date of issue: 2023-07-05 Filename: 253000\_eng.pdf

Refer to "General Notes Relating to Pepperl+Fuchs Product Information".





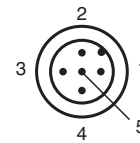
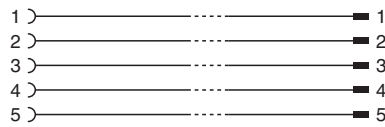
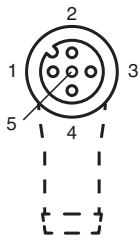

**Technical Data**

Sheathing	PUR based on polyether
Core insulation	PP
Weld spatter resistance	yes
Chemical resistance	good
Oil resistance	yes
Cooling lubricant resistance	yes
Microbial resistance	yes
Hydrolysis resistance	yes
Flammability	FT2

**Connection**



**Accessories**

	<b>MH V1-SCREWDRIVER</b>	Torque screwdriver (0.6 Nm)
	<b>MH V1-BIT M12</b>	plug-in cap M12
	<b>V1/V3-LABELHOLDER</b>	Label holder
	<b>V1/V3-LABEL</b>	Label plate
	<b>MH V1-Holder</b>	Modular universal holder for M12 connectors
	<b>V1-CLIP</b>	Unlocking protector for M12 connector
	<b>V1-MARKING-RING-COLOR</b>	Marking rings for M12 connectors, various colors

Release date: 2023-07-05 Date of issue: 2023-07-05 Filename: 253000\_eng.pdf