

# Cable socket, shielded V15-W-10M-PVC-ABG



- Degree of protection IP68 / IP69
- Shield connected to screw connection
- Specific design protects against loosening and inaccurate installation

Female cordset single-ended M12 angled A-coded, 5-pin, PVC cable grey, shielded



## Dimensions

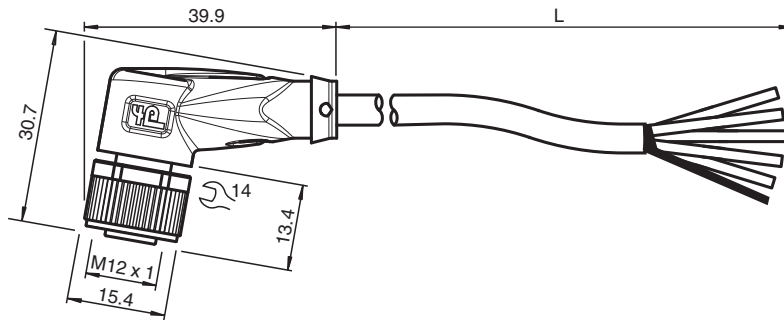

## Technical Data

### General specifications

<b>Connector 1</b>	
Connection	socket
Construction type	M12
Style	angled
Locking	screw connection
Number of pins	5
Coding	A-coded
<b>Connector 2</b>	
Connection	cable end

### Electrical specifications

Operating voltage	$U_B$	max. 48 V AC / 60 V DC
Operating current	$I_B$	max. 4 A

### Conformity

Degree of protection	EN 60529
Plug connection	connector M12 x 1 : IEC 61076-2-101
Flammability	IEC 60332-2-2

### Ambient conditions

<b>Ambient temperature</b>	
Plug connector	-40 ... 90 °C (-40 ... 194 °F)
Cable, fixed	-30 ... 80 °C (-22 ... 176 °F)

Release date: 2023-09-04 Date of issue: 2023-09-05 Filename: 253354\_eng.pdf

Refer to "General Notes Relating to Pepperl+Fuchs Product Information".

Pepperl+Fuchs Group  
www.pepperl-fuchs.com

USA: +1 330 486 0001  
fa-info@us.pepperl-fuchs.com

Germany: +49 621 776 1111  
fa-info@de.pepperl-fuchs.com

Singapore: +65 6779 9091  
fa-info@sg.pepperl-fuchs.com

PEPPERL+FUCHS

## Technical Data

Cable, flexing	-15 ... 80 °C (5 ... 176 °F)	
Pollution degree	3	
<b>Mechanical specifications</b>		
Plug connector		
Tightening torque	0.6 Nm	
Loosening protection	available	
Tool installation	straight knurling and hexagon nut SW = 14 mm	
Mating cycles	min. 100	
Shielding	shield connected to screw connection	
Degree of protection	IP68 / IP69	
Cable	according to IEC/EN 60228 (DIN VDE 0295) class 6	
Sheath diameter	4.8 mm	
Bending radius	> 10 x cable diameter, moving > 5 x cable diameter, fixed	
Sheath stripping force	max. 25 N / 100 mm	
Sheath color	grey (similar to RAL 7001)	
Number of cores	5	
Core cross section	0.34 mm <sup>2</sup>	
Cores color	Core 1: brown Core 2: white Core 3: blue Core 4: black Core 5: grey	
Core construction	19 x 0.15 mm Ø	
Shield	tinned copper braiding, 85 % coverage	
Length	L	10 m
Cable code	Li 9Y YM 5 x 0,34	
<b>Material</b>		
Plug connector		
Screw connection	Zinc diecast, nickel-plated	
Body	TPU, black	
Seal	FKM	
Contact surface	gold plated (Au)	
Flammability	V-2	
Cable		
Sheathing	PVC	
Core insulation	PP	
Flammability	flame-resistant	



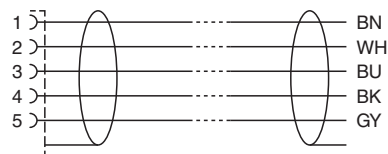
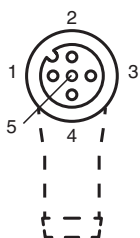



## Connection



## Accessories

	<b>MH V1-SCREWDRIVER</b>	Torque screwdriver (0.6 Nm)
-------------------------------------------------------------------------------------	--------------------------	-----------------------------

## Accessories

	<b>MH V1-BIT M12</b>	plug-in cap M12
	<b>V1/V3-LABELHOLDER</b>	Label holder
	<b>V1/V3-LABEL</b>	Label plate
	<b>MH V1-Holder</b>	Modular universal holder for M12 connectors
	<b>V1-CLIP</b>	Unlocking protector for M12 connector
	<b>V1-MARKING-RING-COLOR</b>	Marking rings for M12 connectors, various colors