

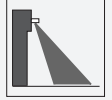

Radar sensor

RaDec-D-NA



- Microwave motion sensor with intelligent functions
- Reliable detection of people and vehicles
- Simplest adjustment of the sensing range
- Wall and ceiling mountable
- Version with direction detection and cross-traffic suppression
- Version with FCC-frequency

FCC-approved standard radar motion sensor offering additional functions, dynamic version offering direction detection, 2 m x 4.5 m detection range, max. installation height: 4 m, black housing, relay contact output, cable connection

Function

The RaDec series consists of affordable radar motion sensors that not only combine all the key requirements of door manufacturers in a compact, stylish device, but are also user friendly and easy to install. An integrated microprocessor with 24 GHz microwave technology ensures a high level of reliability, even in difficult conditions. What's more, the sensor offers two adjustable detection areas, different operating modes, and an installation height of up to 4 m, and operates in a temperature range of -20 °C ... +60 °C. The -D version features rotation direction monitoring; a cross-traffic suppression system can also be connected to this version.

Dimensions

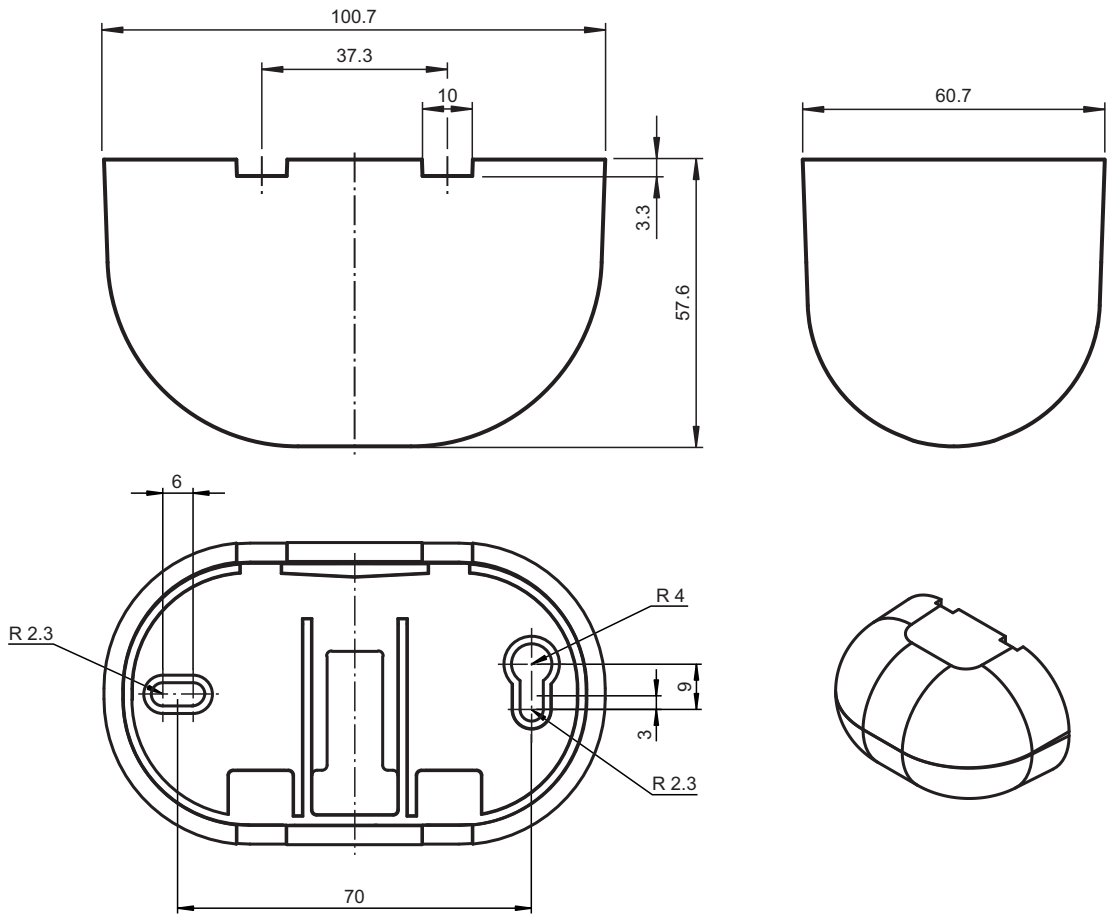

Technical Data

General specifications

Sensing range	broad: 2000x 4500 mm (DxW) at 2200 mm mounting height and 30° tilt angle narrow: 4500x 2000 mm (DxW) at 2200 mm mounting height and 30° tilt angle
Function principle	Microwave module
Detection speed	min. 0.1 m/s
Setting angle	0 ... 90 ° in 5 ° increments
Operating frequency	24.075 ... 24.175 GHz K-Band
Operating mode	Radar motion sensor
Transmitter radiated power (EIRP)	< 20 dBm

Functional safety related parameters

MTTF _d	300 a
Mission Time (T _M)	20 a
Diagnostic Coverage (DC)	0 %

Indicators/operating means

Function indicator	LED red
Control elements	potentiometer , DIP-switch for selection of operating modes
Control elements	sensitivity adjustment

Electrical specifications

Operating voltage	U _B	12 ... 36 V DC , 12 ... 28 V AC
No-load supply current	I ₀	≤ 50 mA at 24 V DC
Power consumption	P ₀	≤ 1.7 W

Output

Switching type	NO/NC
----------------	-------

Release date: 2020-10-08 Date of issue: 2020-10-08 Filename: 258909_eng.pdf

Technical Data

Signal output		Relay, 1 NO contact/NC contact
Switching voltage		max. 48 V AC / 48 V DC
Switching current		max. 0.5 A AC / 1 A DC
Switching power		max. 24 W / 60 VA
De-energized delay	t _{off}	1 s
Approvals and certificates		
FCC approval		FCC Rules part 15 / This device can be used in the USA.
IC approval		RSS210 Issue 8.0 / This device can be used in Canada.
Approvals		Use in countries within the European Union is not permitted. In other countries, all applicable national regulations must be observed.
Ambient conditions		
Operating temperature		-20 ... 60 °C (-4 ... 140 °F)
Storage temperature		-30 ... 70 °C (-22 ... 158 °F)
Relative humidity		max. 90 % non-condensing
Mechanical specifications		
Mounting height		max. 4000 mm
Degree of protection		IP54
Connection		Connecting cable 2.5 m included with delivery
Material		
Housing		PC/ABS black
Mass		130 g
Dimensions		101 mm x 60 mm x 59 mm
Suitable series		
Series		RaDec

Connection Assignment

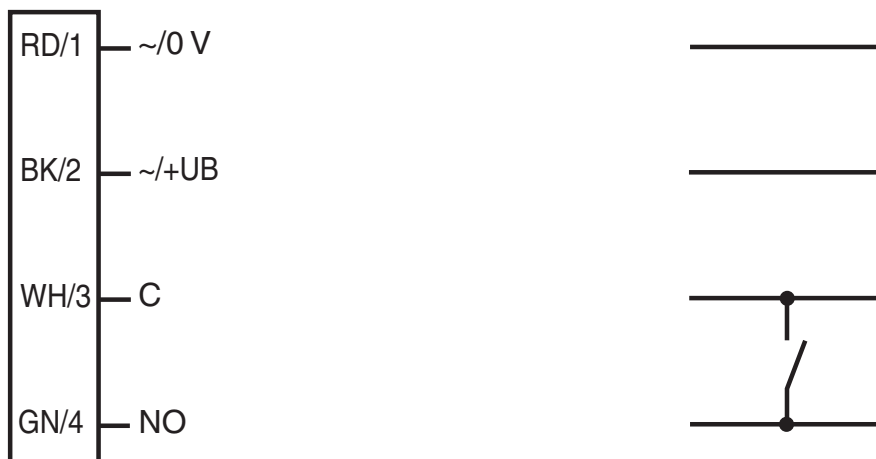

Assembly

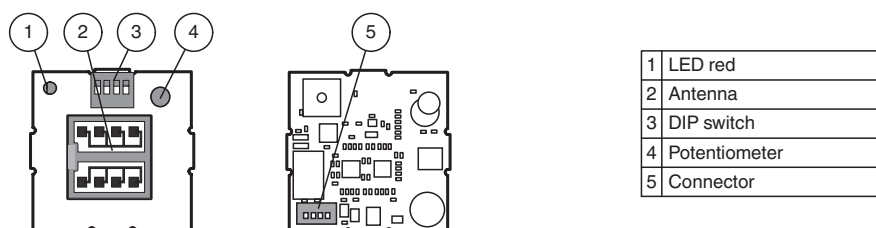

Release date: 2020-10-08 Date of issue: 2020-10-08 Filename: 258909_eng.pdf

Application



Accessories

	RaDec Weather Cap	Weather hood for radar sensors series RaDec
---	--------------------------	---

Release date: 2020-10-08 Date of issue: 2020-10-08 Filename: 258909_eng.pdf

Refer to "General Notes Relating to Pepperl+Fuchs Product Information".

Pepperl+Fuchs Group
www.pepperl-fuchs.com

USA: +1 330 486 0001
fa-info@us.pepperl-fuchs.com

Germany: +49 621 776 1111
fa-info@de.pepperl-fuchs.com

Singapore: +65 6779 9091
fa-info@sg.pepperl-fuchs.com

Function

Detection area

A wide or narrow detection area can be set by turning the PCB.

Detection area wide (Standard)

Detection area narrow

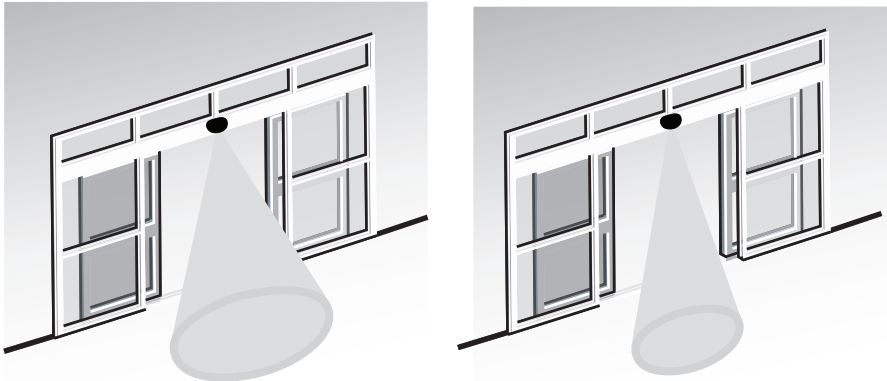

The size of the detection area can be changed using the potentiometer.

With the standard locking discs (already fitted in supplied device) you can set the position of the inclination angle in 10° or 5° increments from 0° to 90°.

By using the supplied locking discs for an inclined detection area (e.g. in revolving doors) the detection field can be rotated 15° left or right.

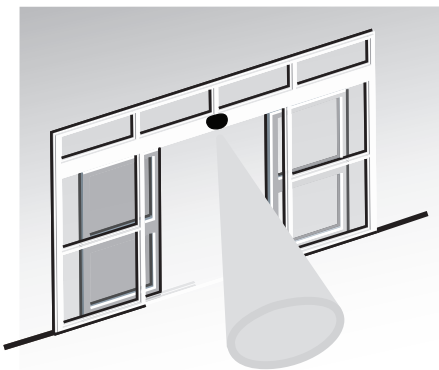

Detection capabilities

Direction detection

With direction detection, it can be set whether the sensor should be triggered by forward movements only or by forward and backward movements.

Cross-traffic suppression

Cross traffic suppression allows for passers-by to be partially suppressed.

Immunity

Immunity allows various external interferences, e.g. rain, vibrations and reflections to be minimized.

Relay contact switching mode

Relay contact when detection is active (NO)

Relay contact when detection is passive (NC)

The setting of the detection capabilities takes place with the DIP switch. The settings are checked by walking in the sensing area.

Accessories

Other suitable accessories can be found at www.pepperl-fuchs.com

Function Principle

Radar sensors are microwave sensors that adopt the principle of Doppler radar. The most important requirement for microwave detection is that the object to be detected is moving. Applications include controlling automatic doors and gates.

The sensor emits microwaves of a defined frequency in order to detect people and large objects moving at speeds between 100 mm/sec. and 5 m/sec. Stationary people or objects are not detected. Based on the latest 24 GHz technology with integrated microprocessor control, these sensors provide a high level of reliability, even in difficult operating conditions. The 24 GHz frequency, known as the 'K-band,' is reserved by CETECOM for this application area worldwide.

The direction detection function makes it possible to distinguish whether persons are moving towards the door or away from it. It is necessary to trigger the opening impulse if people are approaching the door. The sensor ignores objects that are moving away. Cross-traffic suppression serves a similar purpose. Automatic doors are often opened when a pedestrian walks too close to a shop window or a building facade. The cross-traffic suppression function can avoid this, because microwave technology combined with the microprocessor evaluation unit accurately detects these directions of motion. Both functions noticeably quiet the door area, increase the lifetime of the door mechanism, and in doing so help save energy.

Application

- Opening impulse sensors for automatic doors and industrial doors
- Monitoring approach areas to elevators
- Motion sensors for people and objects
- Impulse sensors for escalators