



Read head WCS3B-LS510

- Non-contact, absolute position encoder
- Output of position and speed
- Automatic detection of dirt accumulation
- Unicast communication
- A shared connection for supply and Ethernet

Read head with EtherNet/IP interface



Dimensions

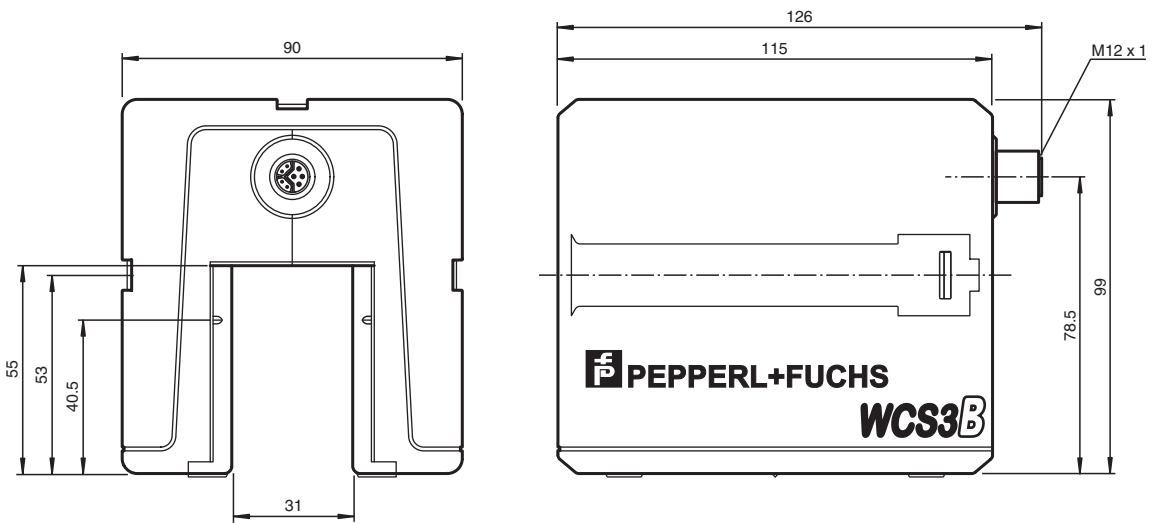

Release date: 2022-10-20 Date of issue: 2022-10-20 Filename: 262006_eng.pdf

Refer to "General Notes Relating to Pepperl+Fuchs Product Information".

Pepperl+Fuchs Group
www.pepperl-fuchs.com

USA: +1 330 486 0001
fa-info@us.pepperl-fuchs.com

Germany: +49 621 776 1111
fa-info@de.pepperl-fuchs.com

Singapore: +65 6779 9091
fa-info@sg.pepperl-fuchs.com

PF PEPPERL+FUCHS

Dimensions



Technical Data

General specifications

| | | |
|------------------------------|---|--|
| Passage speed | v | ≤ 12.5 m/s |
| Measuring range | | max. 314.5 m |
| Free tolerances to code rail | | horizontal: 31 mm (± 15.5 mm) vertical: 28 mm (± 14 mm) |
| Resolution | | ± 0.4 mm (1,250 positions/m) |

Functional safety related parameters

| | | |
|--------------------------------|--|-------|
| MTTF _d | | 172 a |
| Mission Time (T _M) | | 20 a |
| Diagnostic Coverage (DC) | | 0 % |

Indicators/operating means

| | | |
|---------------|--|---|
| LED green | | ETHERNET link To: ETHERNET connection OK |
| LED yellow | | ETHERNET Bus Activity Flashing: data transfer |
| LED red | | ETHERNET communication To: communication error |
| LED red/green | | Status indication Green: code rail detected, normal function Red: system error Flashing red: no code rail detected |

Electrical specifications

| | | |
|-------------------|----------------|----------------|
| Operating voltage | U _B | 10 ... 30 V DC |
| Power consumption | P ₀ | 6 W |

Interface

| | | |
|------------------|--|-------------|
| Interface type | | 100 BASE-TX |
| Data output code | | binary code |
| Protocol | | EtherNet/IP |
| Transfer rate | | 100 MBit/s |

Standard conformity

| | | |
|----------------------|--|---------------------------|
| Emitted interference | | EN 61000-6-4:2007+A1:2011 |
| Noise immunity | | EN 61000-6-2:2005 |

Release date: 2022-10-20 Date of issue: 2022-10-20 Filename: 262006_eng.pdf

Technical Data

| | |
|-----------------------------------|--|
| Shock resistance | EN 60068-2-27:2009 |
| Vibration resistance | EN 60068-2-6:2008 |
| Approvals and certificates | |
| CSA approval | cCSAus Certified, General Purpose Class 2 power source |
| CCC approval | CCC approval / marking not required for products rated ≤36 V |
| Ambient conditions | |
| Operating temperature | 0 ... 60 °C (32 ... 140 °F) |
| Storage temperature | -40 ... 85 °C (-40 ... 185 °F) |
| Relative humidity | 90 % , noncondensing |
| Mechanical specifications | |
| Connection type | 8-pin, M12 x 1 connector socket, Y-coded |
| Cable gland | Max. tightening torque of the cap nut: ≤ 0.4 Nm |
| Degree of protection | IP54 |
| Material | |
| Housing | ABS , PC (Polycarbonate) |
| Mass | 500 g |
| General information | |
| Ordering information | Mounting plate included with delivery |

Connection

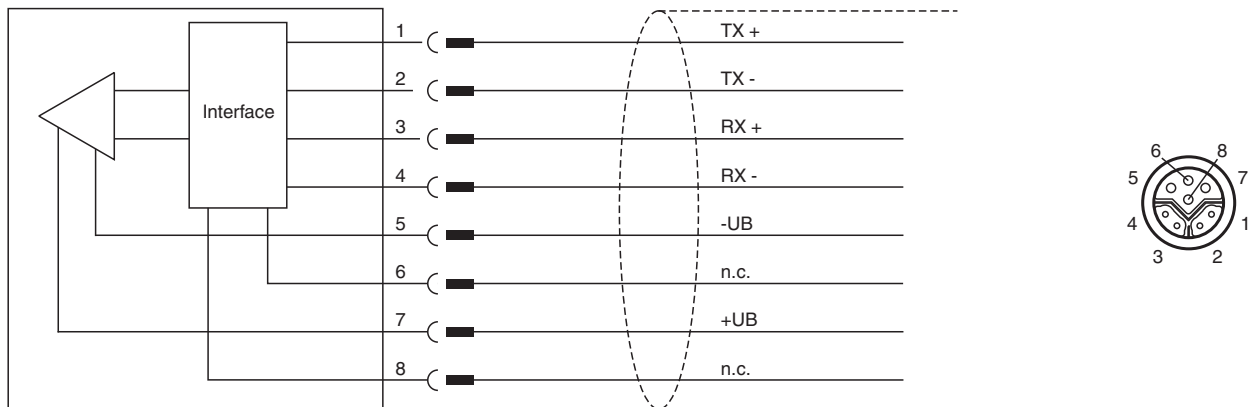





Accessories

| | | |
|--|------------------------------|---|
| | WCS3B-PL2 | Transparent protective case and seal for WCS3B reader |
| | WCS-MP1 | Mounting plate for reading heads WCS2 and WCS3 |
| | V19SY-G-BK10M-PUR-ABG | Male single-ended cordset, M12, 8-pin, Y encryption, PUR cable, shielded |
| | V45-G | Male connector RJ45 straight 4-pin, Cat5, shielded, field-attachable |
| | V45-GP | Male connector RJ45 straight 4-pin, Cat5, shielded, field-attachable, Outdoor |

Release date: 2022-10-20 Date of issue: 2022-10-20 Filename: 262006_eng.pdf

Accessories

| | | |
|---|-----------------------------|--|
|  | V15S-W-ABG-PG9 | Male connector M12 angled A-coded 5-pin, for cable diameter 5 - 8 mm, shielded, field-attachable |
|  | V15S-G-ABG-PG9 | Male connector M12 straight A-coded 5-pin, for cable diameter 5 - 8 mm, shielded, field-attachable |
|  | WCS-V45DIN-8P | Terminal Block |
|  | V19SY-Y-V1D/V1S | Y-Splitter M12 plug 8-pin Y-coded to M12 socket 4-pin D-coded / M12 plug 4-pin A-coded |
|  | V19SY-G-BK*M-PUR-ABG | Ethernet bus cable male cordset single-ended M12 straight Y-coded 8-pin, PUR cable black, Cat5e, shielded, drag chain suitable |