



# Betätiger BT115A

- Für rechts- und linksdrehende Antriebe mit 180° Drehbewegung
- Vier feste, um 90° versetzte Betätigungsfahnen

Betätiger für Baureihe F31

## Abmessungen

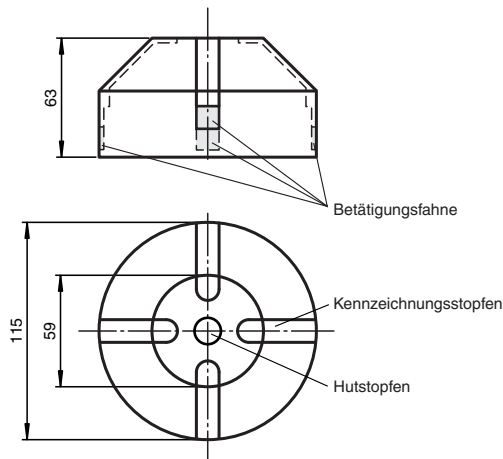

## Technische Daten

<b>Allgemeine Daten</b>	
Ringdurchmesser	max. 110 mm
Sprengringhöhe	max. 7 mm
<b>Umgebungsbedingungen</b>	
Umgebungstemperatur	-25 ... 70 °C (-13 ... 158 °F)
<b>Mechanische Daten</b>	
Wellendurchmesser	< 90 mm
Wellenhöhe	30 mm und 50 mm
Befestigungslochbild	30 x 130 mm
<b>Material</b>	
Gehäuse	Befestigungsteil: PA
Distanzscheibe	PA (2 Stück, 10 mm stark)
Hutstopfen	PE (1 Stück schwarz)
Kennzeichnungsstopfen	PA (2 Stück gelb, 2 Stück schwarz)
Befestigungsschraube	für Betätiger: 1.4305 / AISI 303 (V2A) (1 Stück M6 x 25) für Sensoren -F31: 1.4305 / AISI 303 (V2A) (2 Stück M5 x 16) (2 Stück M5 x 12)
Betätigungsfahne	Edelstahl 1.4305 / AISI 303 (V2A) (integriert)
Masse	120 g
Anzugsmoment Befestigungsschrauben	1,5 Nm

Veröffentlichungsdatum: 2021-04-13 Ausgabedatum: 2021-04-13 Dateiname: 263361\_ger.pdf

Beachten Sie „Allgemeine Hinweise zu Pepperl+Fuchs-Produktinformationen“.

Pepperl+Fuchs-Gruppe  
www.pepperl-fuchs.com















USA: +1 330 486 0001  
fa-info@us.pepperl-fuchs.com

Deutschland: +49 621 776 1111  
fa-info@de.pepperl-fuchs.com

Singapur: +65 6779 9091  
fa-info@sg.pepperl-fuchs.com

**PF** PEPPERL+FUCHS

## Passende Systemkomponenten

	NBN3-F31-E8-K	
	NBN3-F31-E8-K-K	
	NBN3-F31-E8-V1	
	NBN3-F31-E8-V1-Y7011-3680	
	NBN3-F31-E8-V1-FESTO	
	NBN3-F31-E8-V16-V15	
	NBN3-F31K-E8	
	NBN3-F31K-E8-K	
	NBN3-F31K-E8-K-FESTO	
	NBN3-F31K-E8-B13-S-BRAY	
	NBN3-F31K-E8-V1-V1	
	NBN3-F31K-Z8	
	NBN3-F31K-Z8-K-FESTO	
	NBN3-F31K-Z8-V1-V1	
	NBN3-F31K2-E8-B13-S	
	NBN3-F31K2-E8-B33-S	
	NBN3-F31K2-E8-B43-S	
	NBN3-F31K2M-E8-B13-S	
	NBN3-F31K2M-E8-B23-S	
	NBN3-F31K2M-E8-B33-S	
	NBN3-F31K2M-Z8L-B43-S	
	NBN3-F31K2M-E8-B43-S	
	NBN3-F31K2M-Z8L-B13-S	

Veröffentlichungsdatum: 2021-04-13 Ausgabedatum: 2021-04-13 Dateiname: 263361\_ger.pdf

Beachten Sie „Allgemeine Hinweise zu Pepperl+Fuchs-Produktinformationen“.

 Pepperl+Fuchs-Gruppe  
 www.pepperl-fuchs.com





 USA: +1 330 486 0001  
 fa-info@us.pepperl-fuchs.com

 Deutschland: +49 621 776 1111  
 fa-info@de.pepperl-fuchs.com

 Singapur: +65 6779 9091  
 fa-info@sg.pepperl-fuchs.com

 **PEPPERL+FUCHS**

## Passende Systemkomponenten

	NBN3-F31K2M-Z8L-B23-S	
	NCN3-F31K2M-N4-B23-S	
	NBN3-F31K2M-Z8L-B33-S	
	NBN3-F31K2-Z8L-B13-S-Y300073	
	NBN3-F31K2-Z8L-B13-S-Y292890	
	NBN3-F31K2-Z8L-B13-S	
	NBN3-F31K2-Z8L-B33-S	
	NBN3-F31-U8-K	
	NBN3-F31-Z8-K	
	NBN3-F31-Z8-K-K	
	NBN3-F31-Z8-V1-FESTO	
	NCN3-F31-B3B-V1-V1-FESTO	Ventilstellungsrückmelder und Ventilsteuerbaustein
	NCN3-F31-B3B-V1-V1	Ventilstellungsrückmelder und Ventilsteuerbaustein
	NCN3-F31K-B3B-B31	Ventilstellungsrückmelder und Ventilsteuerbaustein
	NCN3-F31K-N4	
	NCN3-F31K2-N4-B13-S	
	NCN3-F31K2-N4-B33-S	
	NCN3-F31K2M-N4-B13-S	
	NCN3-F31K2-N5-B13-S	
	NCN3-F31K2-N5-B33-S	
	NCN3-F31K-N4-B13	

Veröffentlichungsdatum: 2021-04-13 Ausgabedatum: 2021-04-13 Dateiname: 263361\_ger.pdf

Beachten Sie „Allgemeine Hinweise zu Pepperl+Fuchs-Produktinformationen“.

Pepperl+Fuchs-Gruppe  
www.pepperl-fuchs.com













USA: +1 330 486 0001  
fa-info@us.pepperl-fuchs.com

Deutschland: +49 621 776 1111  
fa-info@de.pepperl-fuchs.com

Singapur: +65 6779 9091  
fa-info@sg.pepperl-fuchs.com

 PEPPERL+FUCHS

## Passende Systemkomponenten

	NCN3-F31K-N4-B13-S	
	NCN3-F31K-N4-K-FESTO	
	NCN3-F31K-N4-K	
	NCN3-F31K-N4-K-S	
	NCN3-F31K-N4-S	
	NCN3-F31K-N4-V1-V1	
	NCN3-F31K-N5-K	
	NCN3-F31-N4-K	
	NCN3-F31-N4-K-K	
	NCN3-F31-N4-V1	
	NCN3-F31-N4-V1-FESTO	
	NBN3-F31K2M- E8-B13-S-3G-3D	
	NBN3-F31K2M-Z8L- B13-S-3G-3D	
	NBN3-F31K2M-Z8L- B13-S-3G-3D-Y	
	NBN3-F31K2M-Z8L- B13-S-3G-3D-Y	

Veröffentlichungsdatum: 2021-04-13 Ausgabedatum: 2021-04-13 Dateiname: 263361\_ger.pdf

Beachten Sie „Allgemeine Hinweise zu Pepperl+Fuchs-Produktinformationen“.

Pepperl+Fuchs-Gruppe  
www.pepperl-fuchs.com

USA: +1 330 486 0001  
fa-info@us.pepperl-fuchs.com

Deutschland: +49 621 776 1111  
fa-info@de.pepperl-fuchs.com

Singapur: +65 6779 9091  
fa-info@sg.pepperl-fuchs.com

 **PEPPERL+FUCHS**

## Funktion

Der Betätiger besteht aus einem leitfähigen Kunststoffmaterial, das statische Aufladungen vermeidet und den Einsatz im Ex-Bereich ermöglicht.