



## Thru-beam sensor (pair)

OBE1500-R3F-SE2-0,2M-V31-L



- Very flat design for direct mounting without mounting bracket
- DuraBeam Laser Sensors - durable and employable like an LED
- High detection ranges achievable
- TEACH-IN
- Detection of small parts or flat objects from 0.3 mm

Thru-beam sensor, flat design, M3 mounting, 1500 mm detection range, red light, dark on, PNP output, with 0.2 m fixed cable and M8 plug, 4-pin



### Dimensions

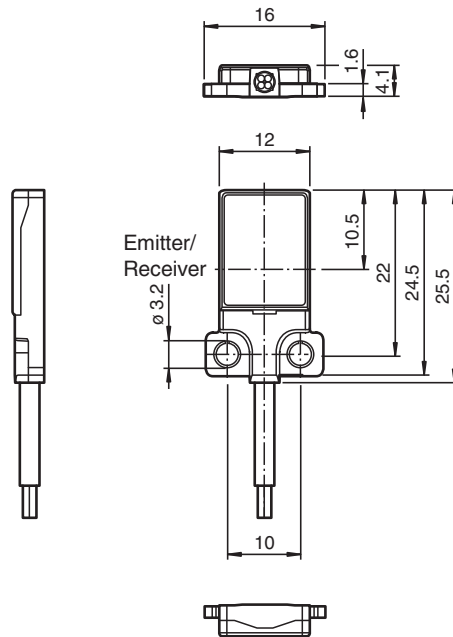

### Technical Data

System components	
Emitter	OBE1500-R3F-SE2-0,2M-V31-L
Receiver	OBE1500-R3F-SE2-0,2M-V31-L
General specifications	
Effective detection range	0 ... 1500 mm
Threshold detection range	2100 m
Light source	LASER LIGHT
Light type	modulated visible red light , 680 nm

Release date: 2023-04-05 Date of issue: 2023-04-05 Filename: 263497\_eng.pdf

Refer to "General Notes Relating to Pepperl+Fuchs Product Information".

Pepperl+Fuchs Group  
www.pepperl-fuchs.com

USA: +1 330 486 0001  
fa-info@us.pepperl-fuchs.com

Germany: +49 621 776 1111  
fa-info@de.pepperl-fuchs.com

Singapore: +65 6779 9091  
fa-info@sg.pepperl-fuchs.com

**PEPPERL+FUCHS**

## Technical Data

<b>Laser nominal ratings</b>		
Note	LASER LIGHT , DO NOT STARE INTO BEAM	
Laser class	1	
Wave length	680 nm	
Beam divergence	> 5 mrad	
Pulse length	approx. 3 $\mu$ s	
Repetition rate	approx. 16.6 kHz	
max. pulse energy	8 nJ	
Angle deviation	approx. 0.5 °	
Object size	typ. starts from 0.7 mm ; typ. from 0.3 mm (after teach-in)	
Diameter of the light spot	approx. 20 mm at a distance of 1.5 m	
Opening angle	approx. 1 °	
Optical face	frontal	
Ambient light limit	EN 60947-5-2 : 25000 Lux	
<b>Functional safety related parameters</b>		
MTTF <sub>d</sub>	806 a	
Mission Time (T <sub>M</sub> )	20 a	
Diagnostic Coverage (DC)	0 %	
<b>Indicators/operating means</b>		
Operation indicator	LED green, statically lit Power on , short-circuit : LED green flashing (approx. 4 Hz)	
Function indicator	Receiver: LED yellow, lights up when light beam is free, flashes when falling short of the operating reserve ; OFF when light beam is interrupted	
<b>Electrical specifications</b>		
Operating voltage	U <sub>B</sub>	12 ... 24 V
No-load supply current	I <sub>0</sub>	Emitter: $\leq$ 10 mA Receiver: $\leq$ 8 mA
Protection class	III	
<b>Input</b>		
Test input	Test of switching function at 0 V	
Switching threshold	Teach-In input	
<b>Output</b>		
Switching type	NO contact / dark-on	
Signal output	1 PNP output, short-circuit protected, reverse polarity protected, open collector	
Switching voltage	max. 30 V DC	
Switching current	max. 50 mA , resistive load	
Voltage drop	U <sub>d</sub>	$\leq$ 1.5 V DC
Switching frequency	f	approx. 2 kHz
Response time	250 $\mu$ s	
<b>Conformity</b>		
Product standard	EN 60947-5-2	
Laser safety	EN 60825-1:2007	
<b>Approvals and certificates</b>		
UL approval	E87056 , cULus Recognized, Class 2 Power Source	
CCC approval	CCC approval / marking not required for products rated $\leq$ 36 V	
FDA approval	IEC 60825-1:2007 Complies with 21 CFR 1040.10 and 1040.11 except for deviations pursuant to Laser Notice No. 50, dated June 24, 2007	
<b>Ambient conditions</b>		
Ambient temperature	-10 ... 60 °C (14 ... 140 °F)	
Storage temperature	-20 ... 70 °C (-4 ... 158 °F)	
<b>Mechanical specifications</b>		
Housing width	16 mm	
Housing height	25.5 mm	
Housing depth	4.1 mm	
Degree of protection	IP67	

Release date: 2023-04-05 Date of issue: 2023-04-05 Filename: 263497\_eng.pdf

Refer to "General Notes Relating to Pepperl+Fuchs Product Information".

Pepperl+Fuchs Group  
www.pepperl-fuchs.comUSA: +1 330 486 0001  
fa-info@us.pepperl-fuchs.comGermany: +49 621 776 1111  
fa-info@de.pepperl-fuchs.comSingapore: +65 6779 9091  
fa-info@sg.pepperl-fuchs.com

**PEPPERL+FUCHS**

## Technical Data

Connection	200 mm fixed cable with 4-pin, M8x1 connector
Material	
Housing	PC (Polycarbonate) and Stainless steel
Optical face	PMMA
Cable	PUR
Mass	approx. 10 g per sensor
Tightening torque, fastening screws	1 Nm
Cable length	200 mm

## Connection

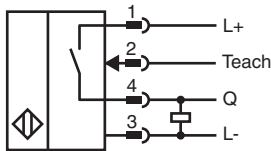
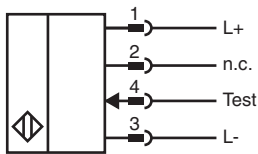

## Connection Assignment



Wire colors in accordance with EN 60947-5-2

1	BN	(brown)
2	WH	(white)
3	BU	(blue)
4	BK	(black)

**Characteristic Curve**

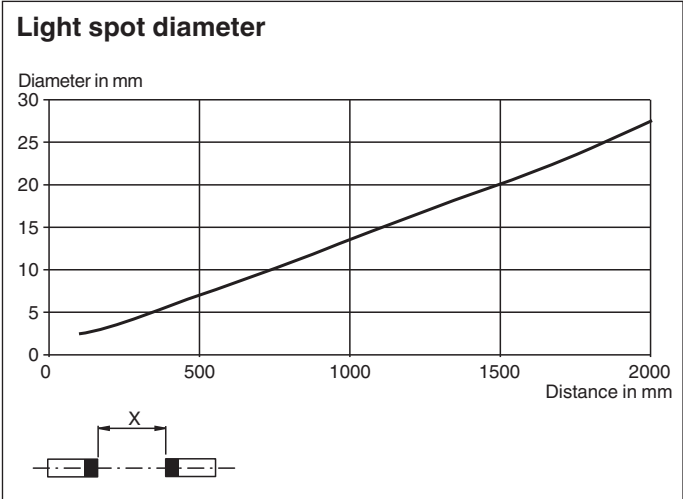
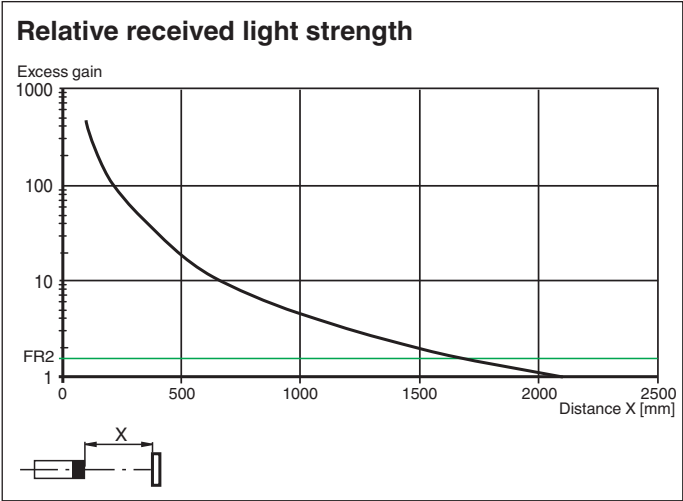
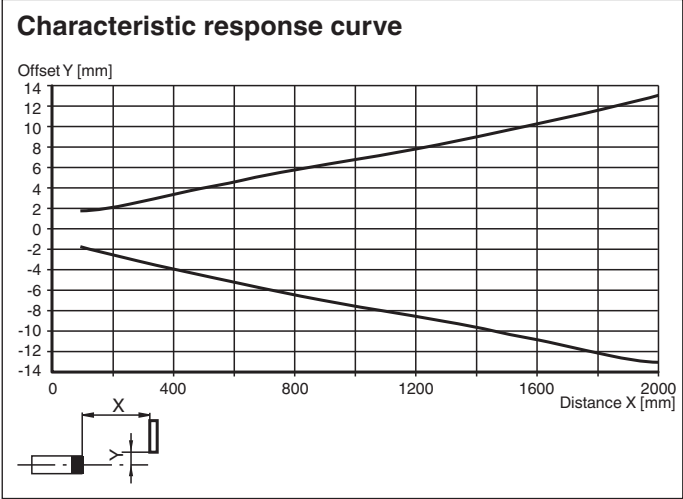

Release date: 2023-04-05 Date of issue: 2023-04-05 Filename: 263497\_eng.pdf

## Safety Information

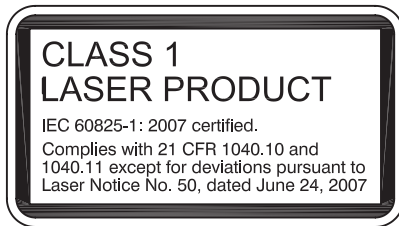
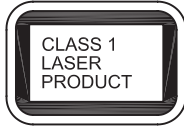

## Safety Information

### Laser Class 1 Information

The irradiation can lead to irritation especially in a dark environment. Do not point at people!

Maintenance and repairs should only be carried out by authorized service personnel!

Attach the device so that the warning is clearly visible and readable.

The warning accompanies the device and should be attached in immediate proximity to the device.

Caution – Use of controls or adjustments or performance of procedures other than those specified herein may result in hazardous radiation exposure.

## Accessories

	<b>V31-GM-2M-PUR</b>	Female cordset single-ended M8 straight A-coded, 4-pin, PUR cable grey
	<b>V31-WM-2M-PUR</b>	Female cordset single-ended M8 angled A-coded, 4-pin, PUR cable grey

**Teach-In**

The thru-beam sensor enables the switching points to be taught in for optimum adaptation to specific applications. This eliminates the need for additional components such as apertures.

The sensitivity of the thru-beam sensor can be adjusted using three Teach-in methods:

**Position Teach**

When using this Teach-in method, the following settings are made on the thru-beam sensor:

- The gain is set to an optimum value
- The signal threshold is set to a minimum

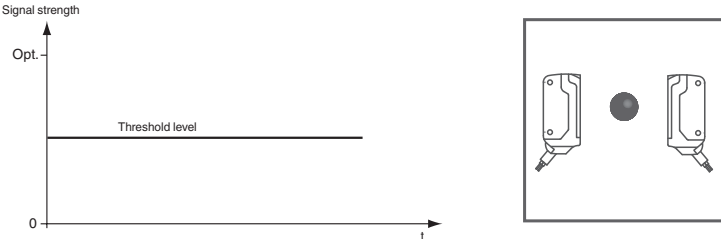

Recommended application:

This method enables minuscule particles in the beam path to be detected, and provides exceptional positioning accuracy. Make sure that there are no objects in the beam path and that the sensor is connected to the power supply.

1. Connect the white cable on the receiver (WH/IN) to the blue cable (BU/0 V) on the receiver.  
The green and yellow LED indicators flash simultaneously at 2.5 Hz
2. Disconnect the white cable on the receiver (WH/IN) from the blue cable (BU/0 V) on the receiver.  
The green and yellow LED indicators flash alternately at 2.5 Hz
3. The end of the Teach-in process is indicated when the green LED indicator lights up static and yellow LED blinks.

**Two-Point Teach-In**

When using this Teach-in method, the following settings are made on the thru-beam sensor:

- The gain is set to an optimum value
- The signal threshold is set in the center between the two taught signal values

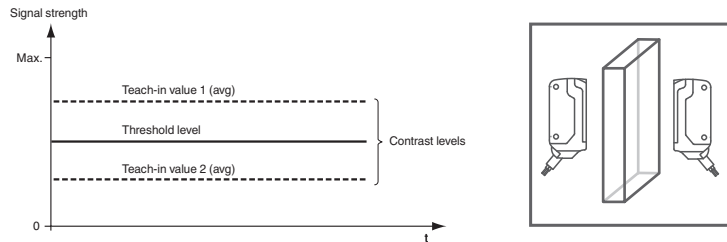

1. Make sure that there are no objects in the beam path and that the sensor is connected to the power supply.
2. Connect the white cable on the receiver (WH/IN) to the blue cable (BU/0 V) on the receiver.  
The green and yellow LED indicators flash simultaneously at 2.5 Hz
3. Position the object in the beam path.
4. Disconnect the white cable on the receiver (WH/IN) from the blue cable (BU/0 V) on the receiver.  
The green and yellow LED indicators flash alternately at 2.5 Hz
5. The end of the Teach-in process is indicated when the green LED indicator lights up static.

**Maximum Teach-In**

When using this Teach-in method, the following settings are made on the thru-beam sensor:

- The gain is set to a maximum
- The signal threshold is set to a minimum

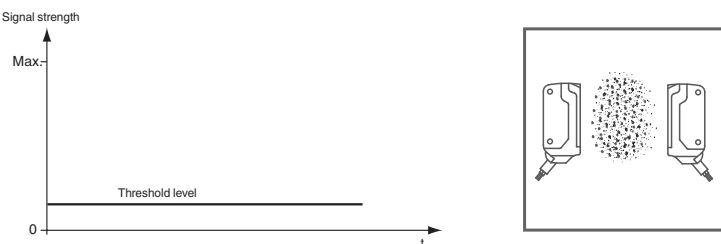

Recommended application:

Enables an object to be detected with a high excess gain. This can be useful if there is severe environmental contamination or to achieve long operating times.

Make sure that there are no objects in the beam path and that the sensor is connected to the power supply.

6. Cover the receiver or transmitter.
7. Connect the white cable on the receiver (WH/IN) to the blue cable (BU/0 V) on the receiver.

Release date: 2023-04-05 Date of issue: 2023-04-05 Filename: 263497\_eng.pdf

## Thru-beam sensor (pair)

OBE1500-R3F-SE2-0,2M-V31-L

The green and yellow LED indicators flash simultaneously at 2.5 Hz

8. Disconnect the white cable on the receiver (WH/IN) from the blue cable (BU/0 V) on the receiver.  
The green and yellow LED indicators flash alternately at 2.5 Hz
9. The end of the Teach-in process is indicated when the green LED indicator lights up static.