

# Cable connector, shielded

## V1S-W-10M-PUR-ABG0



- Degree of protection IP68 / IP69
- Halogen-free
- Shield not connected to screw connection
- Specific design protects against loosening and inaccurate installation

Male cordset single-ended M12 angled A-coded, 4-pin, PUR cable grey, shielded



### Dimensions

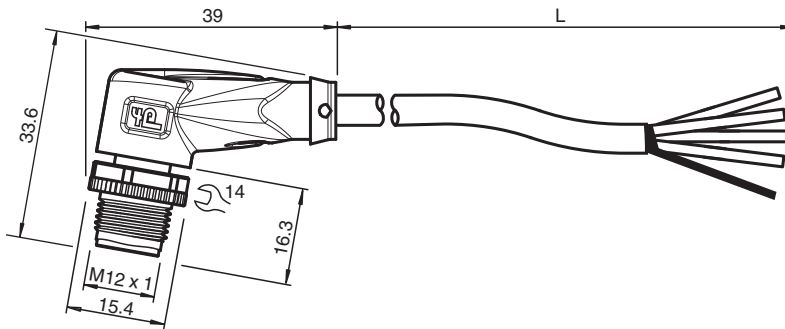

### Technical Data

General specifications			
Connector 1			
Connection		plug	
Construction type		M12	
Style		angled	
Locking		screw connection	
Number of pins		4	
Coding		A-coded	
Connector 2			
Connection		cable end	
Electrical specifications			
Operating voltage	$U_B$	max. 48 V AC / 60 V DC	
Operating current	$I_B$	max. 4 A	
Conformity			
Degree of protection		EN 60529	
Plug connection		connector M12 x 1 : IEC 61076-2-101	
Halogen-free		DIN VDE 0472-815 DIN EN 50267-2-1	
Ambient conditions			
Ambient temperature			
Plug connector		-40 ... 90 °C (-40 ... 194 °F)	
Cable, fixed		-40 ... 80 °C (-40 ... 176 °F)	

Release date: 2023-09-04 Date of issue: 2023-09-04 Filename: 266117\_eng.pdf

Refer to "General Notes Relating to Pepperl+Fuchs Product Information".

Pepperl+Fuchs Group  
www.pepperl-fuchs.com

USA: +1 330 486 0001  
fa-info@us.pepperl-fuchs.com

Germany: +49 621 776 1111  
fa-info@de.pepperl-fuchs.com

Singapore: +65 6779 9091  
fa-info@sg.pepperl-fuchs.com

PEPPERL+FUCHS

## Technical Data

Cable, flexing	-25 ... 80 °C (-13 ... 176 °F)
Pollution degree	3
<b>Mechanical specifications</b>	
Plug connector	
Tightening torque	0.6 Nm
Loosening protection	available
Tool installation	straight knurling and hexagon nut SW = 14 mm
Mating cycles	min. 100
Shielding	shield not connected to connector
Degree of protection	IP68 / IP69
Cable	according to IEC/EN 60228 (DIN VDE 0295) class 5
Sheath diameter	4.8 mm
Bending radius	> 10 x cable diameter, moving > 5 x cable diameter, fixed
Sheath stripping force	max. 100 N / 300 mm
Sheath color	grey (similar to RAL 7001)
Number of cores	4
Core cross section	0.34 mm <sup>2</sup>
Cores color	Core 1: brown Core 2: white Core 3: blue Core 4: black
Core construction	19 x 0.15 mm Ø
Shield	tinned copper braiding, 85 % coverage
Length	L 10 m
Cable code	Li 9Y 11YM 4 x 0.34
<b>Material</b>	
Halogen-free	yes
Plug connector	
Screw connection	Zinc diecast, nickel-plated
Body	TPU, black
Contact surface	gold plated (Au)
Flammability	V-2
Cable	
Sheathing	PUR based on polyether
Core insulation	PP
Chemical resistance	good



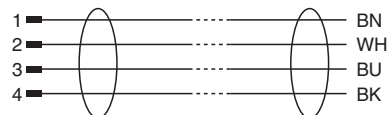
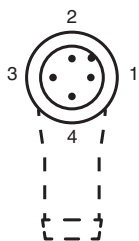



## Connection



## Accessories

	<b>MH V1-SCREWDRIVER</b>	Torque screwdriver (0.6 Nm)
---	--------------------------	-----------------------------

## Accessories

	<b>MH V1-BIT M12</b>	plug-in cap M12
	<b>V1/V3-LABELHOLDER</b>	Label holder
	<b>V1/V3-LABEL</b>	Label plate
	<b>MH V1-Holder</b>	Modular universal holder for M12 connectors
	<b>V1-CLIP</b>	Unlocking protector for M12 connector
	<b>V1-MARKING-RING-COLOR</b>	Marking rings for M12 connectors, various colors