

Relay Module

KFD0-RSH-1.1E.1

- 1-channel signal conditioner
- 24 V DC supply (loop powered)
- Logic input 19 V DC ... 26.5 V DC, non-polarized
- Relay contact output for energized to safe function
- Test pulse immunity
- Up to SIL 3 acc. to IEC/EN 61508



Function

This signal conditioner provides the galvanic isolation between field circuits and control circuits. The device is a relay module that is suitable for safely switching applications of a load circuit. The device isolates load circuits up to 230 V and the 24 V control circuit. The energized to safe (ETS) function is permitted for SIL 3 applications. For testing of the relays, test terminals can be used. The test mode will be indicated by a LED according to NAMUR NE44.

Connection

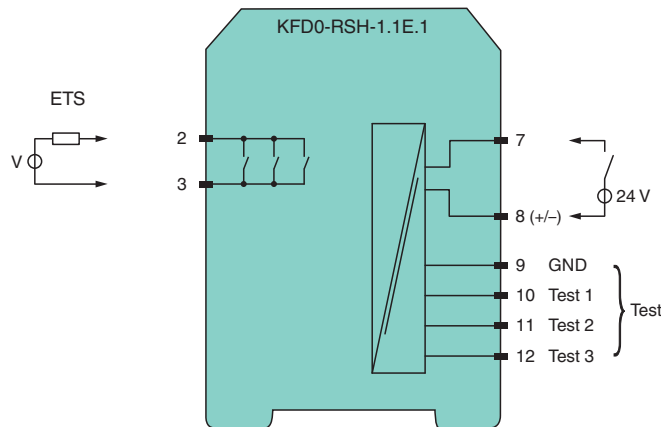

Zone 2

Technical Data

General specifications

Signal type Digital Output

Functional safety related parameters

Safety Integrity Level (SIL) SIL 3
 Systematic capability (SC) SC 3

Supply

Connection loop powered
 Rated voltage U_r 19 ... 30 V DC loop powered
 Power dissipation < 1.5 W
 Power consumption < 1.5 W

Input

Release date: 2022-11-14 Date of issue: 2022-11-14 Filename: 274889_eng.pdf

Refer to "General Notes Relating to Pepperl+Fuchs Product Information".

Pepperl+Fuchs Group
 www.pepperl-fuchs.com

USA: +1 330 486 0002
 pa-info@us.pepperl-fuchs.com

Germany: +49 621 776 2222
 pa-info@de.pepperl-fuchs.com

Singapore: +65 6779 9091
 pa-info@sg.pepperl-fuchs.com

PF PEPPERL+FUCHS

Technical Data

Connection side		control side
Connection		Input terminals 7, 8 ; test input terminals 9, 10, 11, 12
Pulse/Pause ratio		150 ms / 150 ms
Test pulse length		max. 4 ms from DO card
Test input		see functional safety manual
Signal level		0-signal: -5 ... 5 V 1-signal: 19 ... 26.5 V
Rated current	I_r	0-signal: typ. 1.6 mA at 1.5 V DC; typ. 8 mA at 3 V DC (maximum leakage current DO card) 1-signal: ≥ 36 mA (minimum load current DO card)
Output		
Connection side		field side
Connection		terminals 2, 3
Contact loading		253 V AC/5 A/cos ϕ 0.7; 30 V DC/5 A resistive load 253 V AC / 1/2 HP
Minimum switch current		10 mA / 24 V DC
Energized/De-energized delay		150 ms / 150 ms
Mechanical life		5 x 10 ⁶ switching cycles
Transfer characteristics		
Switching frequency		< 3 Hz
Galvanic isolation		
Input/Output		reinforced insulation according to IEC/EN 61010-1, rated insulation voltage 300 V _{eff}
Indicators/settings		
Display elements		LEDs
Labeling		space for labeling at the front
Directive conformity		
Electromagnetic compatibility		
Directive 2014/30/EU		EN 61326-1:2013 (industrial locations)
Low voltage		
Directive 2014/35/EU		EN 61010-1:2010
Machinery Directive		
Directive 2006/42/EC		EN IEC 62061:2021 , EN/ISO 13849-1:2015
Conformity		
Electromagnetic compatibility		NE 21:2012 , EN 61326-3-1:2008 , EN 61326-3-2:2008
Degree of protection		IEC 60529:2013
Ambient conditions		
Ambient temperature		-20 ... 60 °C (-4 ... 140 °F) Observe the temperature range limited by derating, see section derating.
Mechanical specifications		
Degree of protection		IP20
Connection		screw terminals
Mass		approx. 120 g
Dimensions		20 x 119 x 115 mm (0.8 x 4.7 x 4.5 inch) (W x H x D) , housing type B2
Mounting		on 35 mm DIN mounting rail acc. to EN 60715:2001
Data for application in connection with hazardous areas		
Certificate		PF 15 CERT 3933 X
Marking		Ⓜ II 3G Ex nC ec IIC T4 Gc [device in zone 2]
Directive conformity		
Directive 2014/34/EU		EN IEC 60079-0:2018+AC:2020 , EN 60079-7:2015 , EN 60079-15:2010
International approvals		
UL approval		E106378
General information		
Supplementary information		Observe the certificates, declarations of conformity, instruction manuals, and manuals where applicable. For information see www.pepperl-fuchs.com .

Assembly

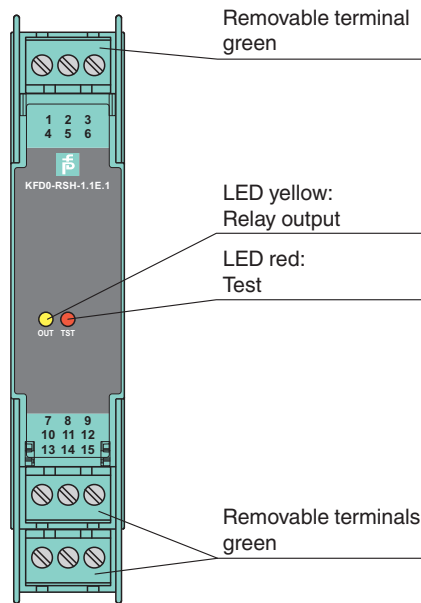

Front view



Matching System Components

	K-DUCT-GY	Profile rail, wiring comb field side, gray
---	------------------	--

Accessories

	KF-ST-5GN	Terminal block for KF modules, 3-pin screw terminal, green
	KF-CP	Red coding pins, packaging unit: 20 x 6

Release date: 2022-11-14 Date of issue: 2022-11-14 Filename: 274889_eng.pdf

Refer to "General Notes Relating to Pepperl+Fuchs Product Information".

Pepperl+Fuchs Group
www.pepperl-fuchs.com

USA: +1 330 486 0002
pa-info@us.pepperl-fuchs.com

Germany: +49 621 776 2222
pa-info@de.pepperl-fuchs.com

Singapore: +65 6779 9091
pa-info@sg.pepperl-fuchs.com

Characteristic Curve

Derating

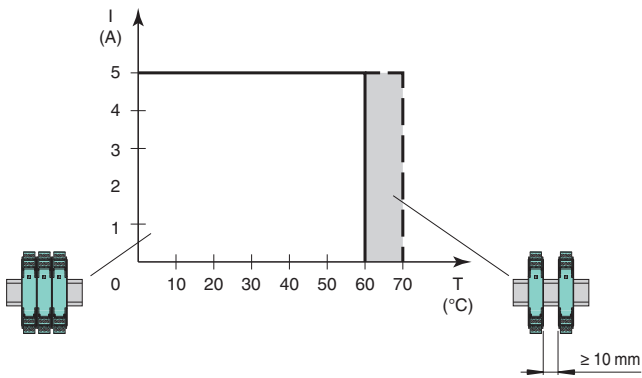

— unfused
 - - - unfused, 10 mm
 U_i 26.5 V

Derating for Zone 2 Application

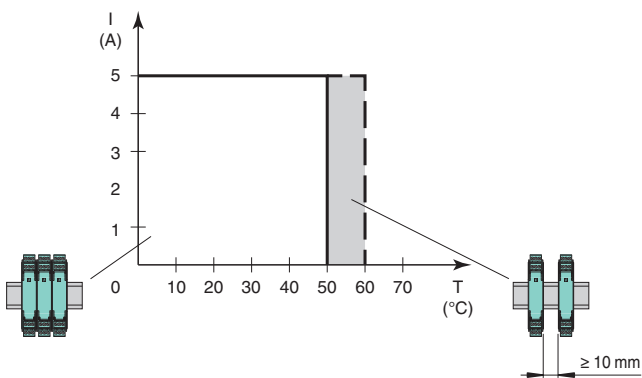

— unfused
 - - - unfused, 10 mm
 U_i 26.5 V

Characteristic Curve

Maximum Switching Power of Output Contacts

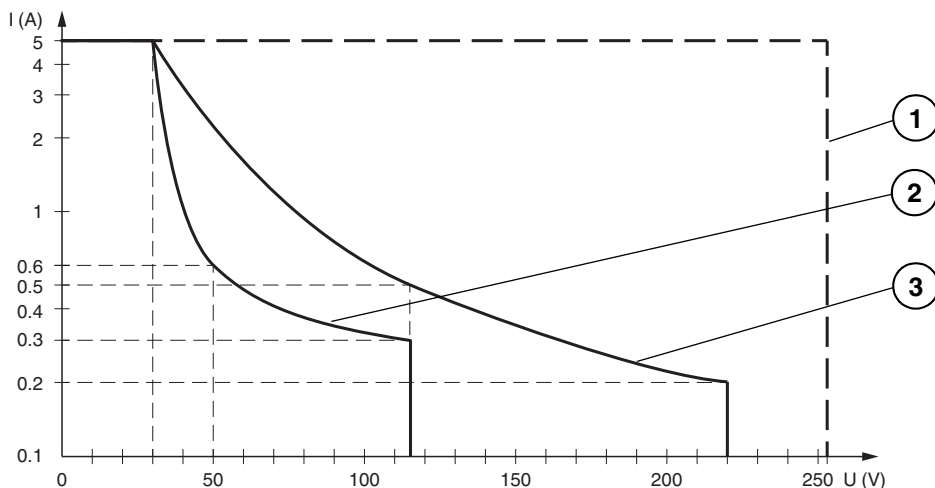

Release date: 2022-11-14 Date of issue: 2022-11-14 Filename: 274899_eng.pdf

Refer to "General Notes Relating to Pepperl+Fuchs Product Information".

- Resistive load DC
- - - - - Resistive load AC
- 1 max. 10^5 switching cycles
- 2 max. 10^5 switching cycles
- 3 max. 3×10^4 switching cycles

The maximum number of switching cycles is depending on the electrical load and may be higher if reduced currents and voltages are applied.

Release date: 2022-11-14 Date of issue: 2022-11-14 Filename: 274889_eng.pdf

Refer to "General Notes Relating to Pepperl+Fuchs Product Information".

Pepperl+Fuchs Group
www.pepperl-fuchs.com

USA: +1 330 486 0002
pa-info@us.pepperl-fuchs.com

Germany: +49 621 776 2222
pa-info@de.pepperl-fuchs.com

Singapore: +65 6779 9091
pa-info@sg.pepperl-fuchs.com