

# Connection cable

## V15-W-E8W-BK1M-PUR-A-V15-G



- Improved resistance to weld spatter
- Suitable for drag chains and abrasion resistant
- Suitable for robotic applications / torsion resistant
- Built-in LED, as operating and function indicator
- Degree of protection IP68 / IP69
- Free of paint wetting interfering substances
- Resistant to microbes and hydrolysis
- UL listed for USA and Canada
- Halogen-free
- Specific design protects against loosening and inaccurate installation

Cordset M12 socket angled A-coded LED 5-pin to M12 plug straight A-coded 5-pin, PUR cable weld spatter resistant black, UL approved, drag chain suitable, torsion resistant



### Dimensions

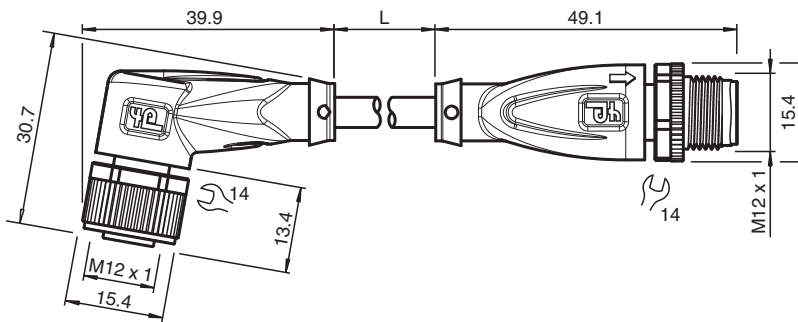

### Technical Data

| General specifications            |                          |
|-----------------------------------|--------------------------|
| <b>Connector 1</b>                |                          |
| Connection                        | socket                   |
| Construction type                 | M12                      |
| Style                             | angled                   |
| Locking                           | screw connection         |
| Number of pins                    | 5                        |
| Coding                            | A-coded                  |
| <b>Connector 2</b>                |                          |
| Connection                        | plug                     |
| Construction type                 | M12                      |
| Style                             | straight                 |
| Locking                           | screw connection         |
| Number of pins                    | 5                        |
| Coding                            | A-coded                  |
| <b>Indicators/operating means</b> |                          |
| LED green                         | Operating display        |
| LED yellow                        | Functional display pin 4 |
| LED white                         | Functional display pin 2 |

Release date: 2023-07-05 Date of issue: 2023-07-05 Filename: 278773\_eng.pdf

Refer to "General Notes Relating to Pepperl+Fuchs Product Information".

Pepperl+Fuchs Group  
www.pepperl-fuchs.com

USA: +1 330 486 0001  
fa-info@us.pepperl-fuchs.com

Germany: +49 621 776 1111  
fa-info@de.pepperl-fuchs.com

Singapore: +65 6779 9091  
fa-info@sg.pepperl-fuchs.com

**PEPPERL+FUCHS**

## Technical Data

| Electrical specifications  |                |   |
|----------------------------|----------------|---|
| Operating voltage          | U <sub>B</sub> | max. 24 V DC -20 % / +25 %  |
| Operating current          | I <sub>B</sub> | max. 4 A  |
| Conformity                 |                |   |
| Degree of protection       |                | EN 60529  |
| Plug connection            |                | connector M12 x 1 : IEC 61076-2-101   |
| Flammability               |                | UL 1581; DIN EN 60332-2-2   |
| Halogen-free               |                | DIN VDE 0472-815<br>IEC 60754-1   |
| Microbial resistance       |                | DIN EN 50525-2-21 / DIN VDE 0282-10   |
| Hydrolysis resistance      |                | DIN EN 50525-2-21   |
| Approvals and certificates |                |   |
| UL approval                |                | AWM STYLE 20549 AWM I/II A/B 80°C 300V FT2 (cable)                              |
| UL File Number             |                | E231213   |
| Ambient conditions         |                |   |
| Ambient temperature        |                |   |
| Plug connector             |                | -40 ... 90 °C (-40 ... 194 °F)  |
| Cable, fixed               |                | -40 ... 80 °C (-40 ... 176 °F)  |
| Cable, flexing             |                | -25 ... 80 °C (-13 ... 176 °F)  |
| Pollution degree           |                | 3   |
| Mechanical specifications  |                |   |
| Plug connector             |                |   |
| Tightening torque          |                | 0.6 Nm  |
| Loosening protection       |                | available   |
| Tool installation          |                | straight knurling and hexagon nut SW = 14 mm                                    |
| Mating cycles              |                | min. 100  |
| Degree of protection       |                | IP68 / IP69   |
| Cable                      |                | according to IEC/EN 60228 (DIN VDE 0295) class 6                                |
| Sheath diameter            |                | 4.7 mm  |
| Bending radius             |                | > 10 x cable diameter, moving<br>> 5 x cable diameter, fixed                    |
| Sheath stripping force     |                | max. 80 N / 300 mm  |
| Sheath color               |                | black (similar to RAL 9005)   |
| Number of cores            |                | 5   |
| Core cross section         |                | 0.34 mm <sup>2</sup>  |
| Cores color                |                | Core 1: brown<br>Core 2: white<br>Core 3: blue<br>Core 4: black<br>Core 5: grey |
| Core construction          |                | 42 x 0.1 mm Ø   |
| Length                     | L              | 1 m   |
| Cable code                 |                | Li F 9Y 11Y 5 x 0,34  |
| Drag chain suitability     |                |   |
| Drag chain cycles          |                | min. 5000000  |
| Motion velocity            |                | max. 3.3 m/s  |
| Traverse distance          |                | max. 5 m  |
| Acceleration               |                | max. 5 m/s <sup>2</sup>   |
| Torsion cycles             |                | min. 1000000  |
| Torsional stress           |                | ± 180 °/m   |
| Material                   |                |   |
| PWIS free                  |                | yes   |
| Halogen-free               |                | yes   |
| Plug connector             |                |   |
| Screw connection           |                | Zinc diecast, nickel-plated   |

Release date: 2023-07-05 Date of issue: 2023-07-05 Filename: 278773\_eng.pdf

Refer to "General Notes Relating to Pepperl+Fuchs Product Information".

Pepperl+Fuchs Group  
www.pepperl-fuchs.comUSA: +1 330 486 0001  
fa-info@us.pepperl-fuchs.comGermany: +49 621 776 1111  
fa-info@de.pepperl-fuchs.comSingapore: +65 6779 9091  
fa-info@sg.pepperl-fuchs.com

**PEPPERL+FUCHS**





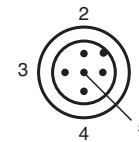
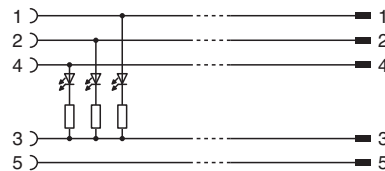
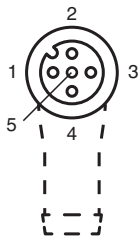

### Technical Data

|                              |                        |
|------------------------------|------------------------|
| Body                         | TPU, transparent/black |
| Seal                         | FKM                    |
| Contact surface              | gold plated (Au)       |
| Flammability                 | V-2                    |
| Cable                        |                        |
| Sheathing                    | PUR based on polyether |
| Core insulation              | PP                     |
| Weld spatter resistance      | yes                    |
| Chemical resistance          | good                   |
| Oil resistance               | yes                    |
| Cooling lubricant resistance | yes                    |
| Microbial resistance         | yes                    |
| Hydrolysis resistance        | yes                    |
| Flammability                 | FT2                    |

### Connection



### Accessories

|   |                              |  |
|---|------------------------------|--|
|  | <b>MH V1-SCREWDRIVER</b>     | Torque screwdriver (0.6 Nm)                      |
|  | <b>MH V1-BIT M12</b>         | plug-in cap M12                                  |
|  | <b>V1/V3-LABELHOLDER</b>     | Label holder                                     |
|  | <b>V1/V3-LABEL</b>           | Label plate                                      |
|  | <b>MH V1-Holder</b>          | Modular universal holder for M12 connectors      |
|  | <b>V1-CLIP</b>               | Unlocking protector for M12 connector            |
|  | <b>V1-MARKING-RING-COLOR</b> | Marking rings for M12 connectors, various colors |

Release date: 2023-07-05 Date of issue: 2023-07-05 Filename: 278773\_eng.pdf