

Connection cable, shielded

V1-W-BK5M-PUR-U5/ABG-V1-W



- Degree of protection IP68 / IP69
- Resistant to microbes and hydrolysis
- UV resistant
- UL listed for USA and Canada
- Halogen-free
- Shield connected to screw connection
- Specific design protects against loosening and inaccurate installation

Cordset M12 socket angled to M12 plug angled A-coded, 4-pin, PUR cable black, shielded, UL-approved



Dimensions

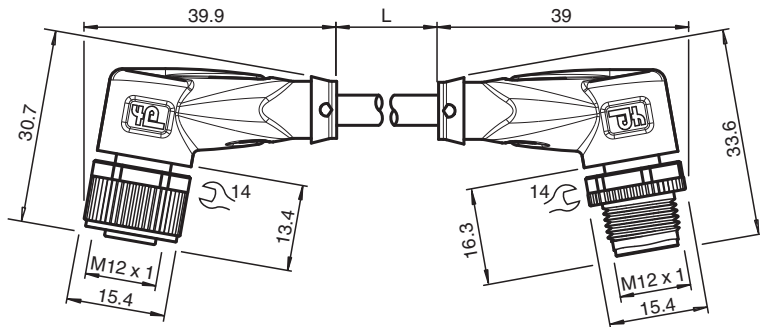

Technical Data

General specifications			
Connector 1			
Connection			socket
Construction type			M12
Style			angled
Locking			screw connection
Number of pins			4
Coding			A-coded
Connector 2			
Connection			plug
Construction type			M12
Style			angled
Locking			screw connection
Number of pins			4
Coding			A-coded
Electrical specifications			
Operating voltage	U _B		max. 48 V AC / 60 V DC
Operating current	I _B		max. 4 A
Conformity			
Degree of protection			EN 60529
Plug connection			connector M12 x 1 : IEC 61076-2-101

Release date: 2023-07-13 Date of issue: 2023-07-13 Filename: 281668_eng.pdf

Refer to "General Notes Relating to Pepperl+Fuchs Product Information".

Pepperl+Fuchs Group
www.pepperl-fuchs.com

USA: +1 330 486 0001
fa-info@us.pepperl-fuchs.com

Germany: +49 621 776 1111
fa-info@de.pepperl-fuchs.com

Singapore: +65 6779 9091
fa-info@sg.pepperl-fuchs.com

PF PEPPERL+FUCHS

Technical Data

Flammability	UL 1581; DIN EN 60332-2-2	
Halogen-free	DIN VDE 0472-815 / DIN EN 50267-2-1	
Approvals and certificates		
UL approval	AWM STYLE 21924/11558 105°C 300V AWM I A/B 105°C 300V FT2 (cable)	
UL File Number	E231213	
Ambient conditions		
Ambient temperature		
Plug connector	-40 ... 90 °C (-40 ... 194 °F)	
Cable, fixed	-50 ... 105 °C (-58 ... 221 °F)	
Cable, flexing	-30 ... 105 °C (-22 ... 221 °F)	
Pollution degree	3	
Mechanical specifications		
Plug connector		
Tightening torque	0.6 Nm	
Loosening protection	available	
Tool installation	straight knurling and hexagon nut SW = 14 mm	
Mating cycles	min. 100	
Shielding	shield connected to screw connection	
Degree of protection	IP68 / IP69	
Cable	according to IEC/EN 60228 (DIN VDE 0295) class 6	
Sheath diameter	6 mm	
Bending radius	> 10 x cable diameter, moving > 5 x cable diameter, fixed	
Sheath stripping force	max. 80 N / 300 mm	
Sheath color	black (similar to RAL 7021)	
Number of cores	4	
Core cross section	0.5 mm ²	
Cores color	Core 1: brown Core 2: white Core 3: blue Core 4: black	
Core construction	28 x 0.15 mm Ø	
Shield	tinned copper braiding, 85 % coverage	
Length	L	5 m
Cable code	Li 9Y C11Y 4 x 0,50	
Material		
Halogen-free	yes	
Plug connector		
Screw connection	Zinc diecast, nickel-plated	
Body	TPU, black	
Seal	FKM	
Contact surface	gold plated (Au)	
Flammability	V-2	
Cable		
Sheathing	PUR based on polyether	
Core insulation	PP	
UV resistance	yes	
Microbial resistance	yes	
Hydrolysis resistance	yes	
Flammability	FT2	

Release date: 2023-07-13 Date of issue: 2023-07-13 Filename: 281668_eng.pdf

Refer to "General Notes Relating to Pepperl+Fuchs Product Information".





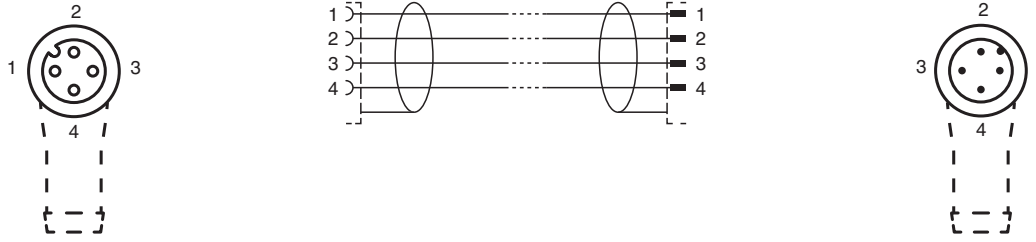

Pepperl+Fuchs Group
www.pepperl-fuchs.comUSA: +1 330 486 0001
fa-info@us.pepperl-fuchs.comGermany: +49 621 776 1111
fa-info@de.pepperl-fuchs.comSingapore: +65 6779 9091
fa-info@sg.pepperl-fuchs.com

PEPPERL+FUCHS

Connection



Accessories

	MH V1-SCREWDRIVER	Torque screwdriver (0.6 Nm)
	MH V1-BIT M12	plug-in cap M12
	V1/V3-LABELHOLDER	Label holder
	V1/V3-LABEL	Label plate
	MH V1-Holder	Modular universal holder for M12 connectors
	V1-CLIP	Unlocking protector for M12 connector
	V1-MARKING-RING-COLOR	Marking rings for M12 connectors, various colors